

Planer

Model 4430

Owner's Manual

For Models Manufactured Since 04/2019

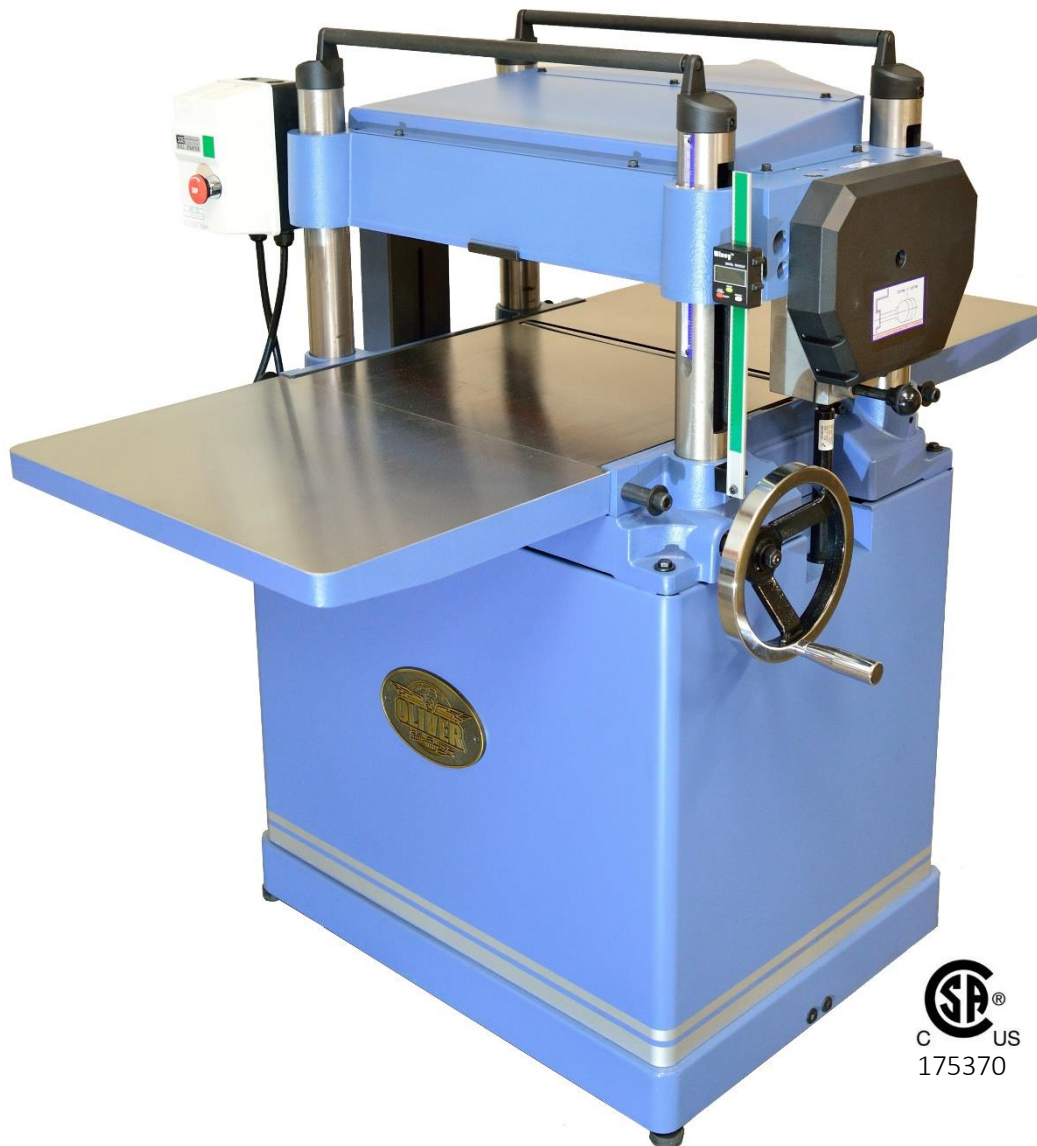

CSA[®]
C US
175370

Oliver Machinery
1-800-559-5065
921 Thomas Ave SW
Renton, WA 98057

info@olivermachinery.net
WWW.OLIVERMACHINERY.NET

Stock Number: 4430.201
Manual Version: 1.0.6



READ AND UNDERSTAND ALL INSTRUCTIONS IN THIS MANUAL BEFORE ATTEMPTING TO ASSEMBLE OR OPERATE THE MACHINE.

FOLLOW THE INSTRUCTIONS AND THINK SAFETY!

THE OWNER OF THIS MACHINE IS SOLELY RESPONSIBLE FOR THE SAFETY OF ANYONE USING THIS MACHINE. SUCH RESPONSIBILITY INCLUDES BUT NOT LIMITED TO:

- **PROPER ASSEMBLY, OPERATION, INSPECTION, MAINTENANCE, AND RELOCATION OF THE MACHINE.**
- **PROPER TRAINING FOR THE OPERATORS AND ENSURES THIS MANUAL IS AVAILABLE AT ALL TIMES.**
- **USAGE AUTHORIZATION.**
- **USAGE OF SAFETY AND PROTECTION DEVICES.**

OLIVER MACHINERY DISCLAIMS ANY LIABILITY FOR MACHINES THAT HAVE BEEN ALTERED OR ABUSED. OLIVER MACHINERY RESERVES THE RIGHT TO EFFECT AT ANY TIME, WITHOUT PRIOR NOTICE, THOSE ALTERATIONS TO PARTS, FITTINGS, AND ACCESSORY EQUIPMENT WHICH THEY MAY DEEM NECESSARY FOR ANY REASON WHATSOEVER.

**** SAVE THIS MANUAL FOR FUTURE REFERENCES. ****

PROP 65 NOTICE

WARNING: Drilling, sawing, sanding, or machining wood products can expose you to wood dust, and/or other chemicals that are known to the State of California to cause cancer, birth defects, or other reproductive harm.

Some examples of these chemicals are:

- Lead from lead-based paints.
- Crystalline silica from bricks, cement, and other masonry products.
- Arsenic and chromium from chemically treated lumber.

Avoid inhaling wood dust and other harmful chemicals. Use a dust mask and/or other safety devices for personal protection.

For more information go to <http://www.P65Warnings.ca.gov/wood>

Table of Contents

Introduction	6	Cleaning	22
Specifications	7	Assembly	22
Quick View	7	Installing Height Adjustment Handwheel.....	23
Product Dimensions	7	Installing Dust Hood.....	23
Shipment Info	7	Installing Extension Tables.....	24
Electricals	7	Installing Power Switch.....	25
Motor	8	Dust Collection	26
Planer Capacity and Performance	8	Wiring and Grounding	26
Cutterhead and Headstock	8	Wiring Instructions.....	26
Measurements	8	Break-in Period	26
Table	9	Controls and Components	27
Safety	9	ON / OFF Switches	27
Others	9	Cutterhead Height Adjustment	27
Identification	10	Cutterhead Height Scale	27
Safety	13	Digital Readout (DRO)	28
General Safety Guidelines	13	Feed Rate Control	28
Safety Guidelines Specific to Planer	14	Components for Planing Wood	29
Electricals	16	Test Run	30
Minimum Circuit Size Required for Model		Operation	31
4430 Planer	16	Step 1: Preparation	31
Grounding	16	Step 2: Setting Depth of Cut and Feed Rate	32
Electrical Wiring	16	Step 3: Select Feed Direction	33
Setup	18	Step 4: Planing Wood to Desired Thickness	33
Shop Preparation	18	Common Cutting Problems	35
Space Requirement.....	18	Snipe.....	35
Load Limits.....	18	Chipping.....	35
Electricals.....	18	Indentation.....	35
Lighting.....	18	Fuzzy Grain.....	35
Safety Labels.....	18	Accessories	36
Dust Collection.....	18	Cutter Inserts	36
Receiving	19	Touchup Paint	36
Moving Machine into the Shop.....	19	Maintenance	37
Unboxing.....	19	Maintenance Schedule	37
Inventory.....	20	Lubrication Schedule	37
Removing Machine from Crate.....	21		

Instructions for Maintenance and	
Adjustments	39
Remove Planer Top Cover	39
Adjust Chip Deflector Clearance	39
Service Cutterhead and Rotate Cutter Inserts	40
Adjust Belt Tension	41
Adjust Headstock Chain Tension	42
Adjust Table Roller Height	42
Adjust Cutterhead/Feed Roller Height Offset	43
Adjust Feed Roller Tension	45
Adjust Cutterhead Height Scale	46
Anti-Kickback Fingers Inspection	46
Troubleshooting	47
Wiring Diagram	50

Parts List	51
Table Assembly	51
Cabinet Assembly	52
Motor Mount Assembly	53
Headstock Assembly	54
Gearbox Assembly	55
Cover and Dust Hood Assembly	55
Maintenance Record	62
Notes	63
Warranty and Service	64

Introduction

Thank you for choosing Oliver! This manual contains important information on how to safely set up, operate, and maintain this machine. Please take the time to read through this manual, and make sure you understand all the instructions.

While this manual may provide tips on optimizing the result of your workpiece, the manual is not intended as a substitute for formal woodworking training. If you need to know how to safely complete a woodworking task, please consult knowledgeable and qualified sources before proceeding further.

We made every effort to keep this manual up-to-date. Instructions, specifications, drawings, and photographs in this manual should match the machine delivered. If you find any differences, or anything that seems confusing in this manual, or some instructions are not available, please check our website for an updated version:

WWW.OLIVERMACHINERY.NET/MANUALS

Alternatively, you can contact our technical support for help:

1-800-559-5065

Before calling, please note down the manufacture date and the serial number of the machine. You can find the information on a nameplate located on the machine cabinet below the power switch. This information is needed to provide proper technical support, and to determine if an updated manual is available for your machine.

Please let us know how well this manual serves you. If you have any suggestions, please call the number above or email us at:

info@olivermachinery.net

We love to hear from our customers and make improvements.

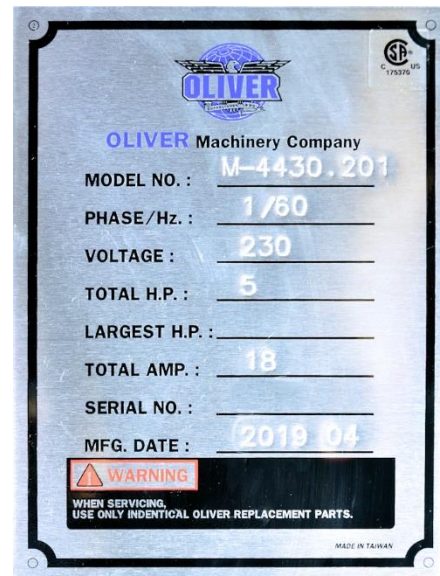

Specifications

Quick View

Model	4430 Planer
Stock Number	4430.201
Motor	TEFC Induction Motor 5HP, 230V, 1Ph
Max. Stock Width	20"
Max Depth of Cut	1/8" (Full width) 1/4" (Stock less than 8" wide)
Dimensions	51"(L) x 40"(W) x 46-1/2"(H)
Footprint	22-1/2"(L) x 28-3/4"(W)
Fully Assembled Weight	546 lbs.
Warranty	1 Year (Motor and electronics) 2 Years (All other parts)

Product Dimensions

Width x Depth x Height (Fully Assembled)	51"(L) x 40"(W) x 46-1/2"(H)
Footprint	22-1/2" (L) x 28-3/4"(W)
Fully Assembled Weight	546 lbs.

Shipment Info

Type	Wood Crate with Pallet Base
Content	Planer with Included Accessories
Dimensions	38-1/4" (L) x 32"(W) x 51-3/4"(H)
Weight	625 lbs.
Approximate Setup Time	60 minutes
Must Ship Upright	YES
Stackable	NO

Electricals

Power Requirement	230V, 1Ph, 60Hz
Full Load Current Rating	18A
Recommended circuit size	30A
Power Switch Type	Magnetic switch with overload protection.
Connection Type	5' 12 AWG Cord included. Electrical hookups required.
Overload Protection	Equipped

Motor

Motor Type	TEFC Induction Motor
Horsepower	5HP
Speed	3450 RPM
Efficiency / Power Factor	75% / 98%
Power Transfer Mechanism	Poly V-belt and pulleys
Bearing type	Permanently sealed ball bearing

Planer Capacity and Performance

Maximum Stock Width	20"
Maximum Depth of Cut	1/4" (Stock less than 8" wide) 1/8" (Full Width)
Maximum Stock Thickness	8"
Minimum Stock Thickness	1/4"
Minimum Stock Length	7"
Feed Rate	16/20 FPM
Number of Cuts Per Square Inch	89 @ 16FPM 71 @ 20FPM

Cutterhead and Headstock

Cutterhead Type	Helical
Cutterhead Diameter	3-1/4"
Cutterhead Speed	5000 RPM
Number of Cutter Inserts	68
Number of Rows of Cutter Inserts	4
Cutter Insert Type	Four-sided, indexable German-made carbide
Cutter Insert Diameters	15mm x 15mm x 2.5mm
Cutter Blade Angle	30 degree
Cutter Insert Screw Tensioning Torque	50-55 lbs.-inch
Infeed Roller Type	Serrated steel
Outfeed Roller Type	Smooth steel
Headstock Height Change Per Each Turn of Handwheel	Approx. 1/16" / 1.5mm
Stock Return Roller Load Limit	220 lbs.

Measurements

Measurement Units	Inch/mm
Measurement Devices	Wixey Digital Readout
Resolution	1/32"/0.002"/0.05mm
Accuracy	+/- 1/250"/0.004"/0.1mm
Backup Measurement Device	Standard headstock height scale installed.

Table

Table Dimensions	51" x 20" (With infeed/outfeed table) 21" x 20" (Without infeed/outfeed table)
Table Height Above Ground	29-3/4"
Material	Precision ground cast iron
Bed Roller	One (past cutterhead)
Extension Table Weight	29 lbs.

Safety

Number of Dust Ports	1
Dust Port Size	5"
Minimum CFM Required	650 CFM
Sound Rating @ 2' distance	85 dB

Others

Serial Number Location	On the machine cabinet below the power switch.
Spare Parts Included	10 Cutter inserts and compatible Torx screws.
Certification	CSA 175370
Country of Origin	Taiwan

Identification

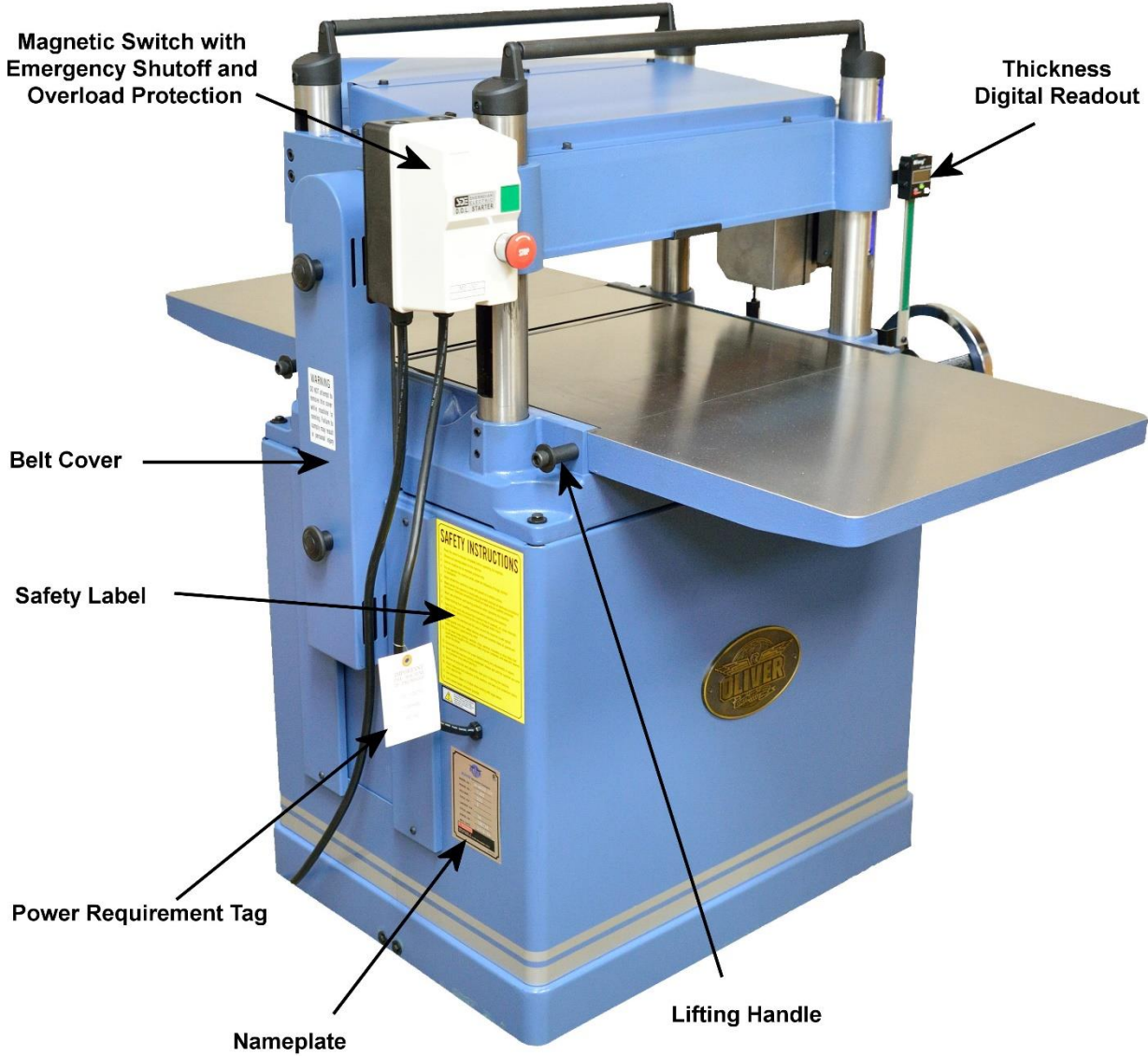

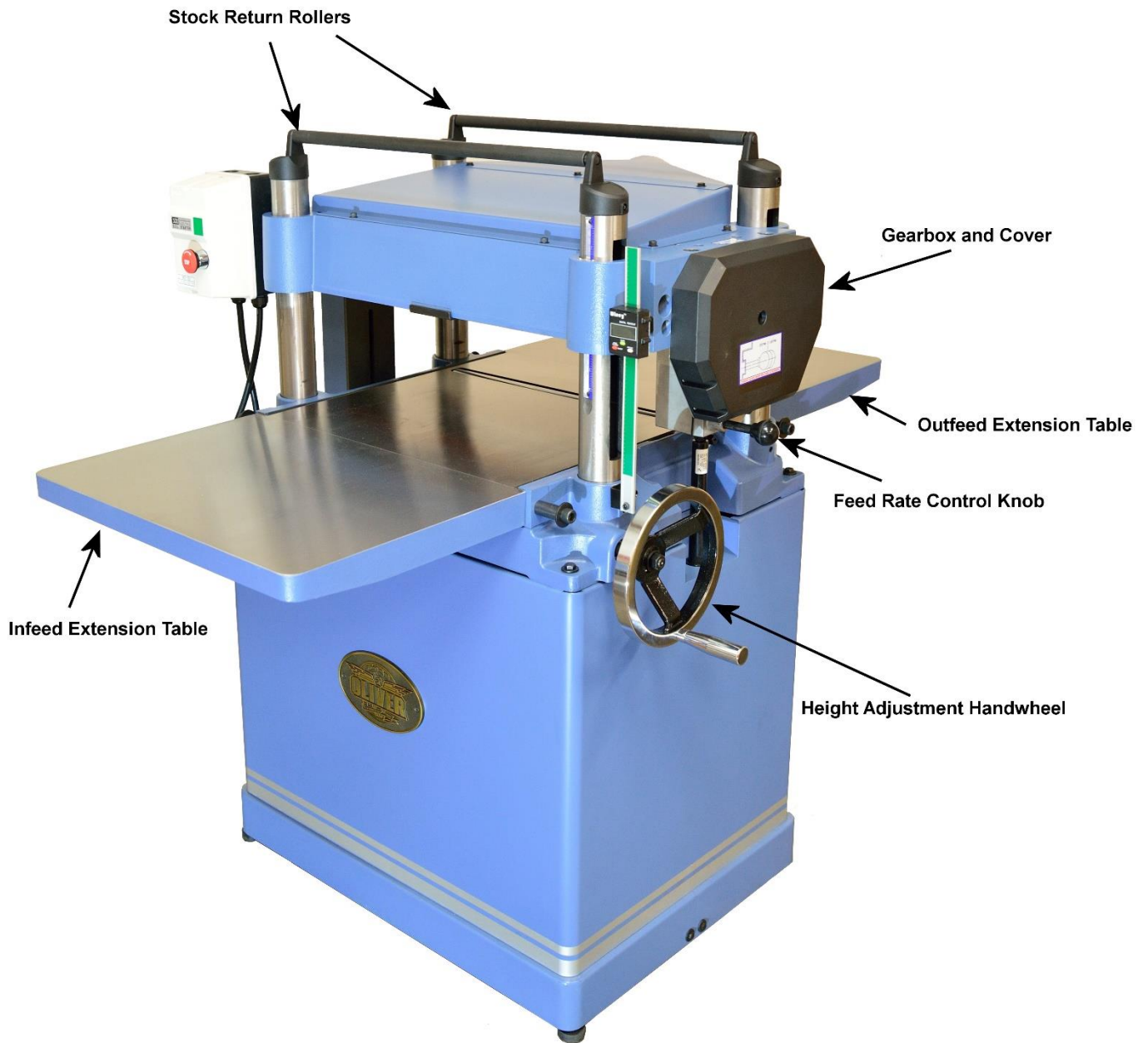

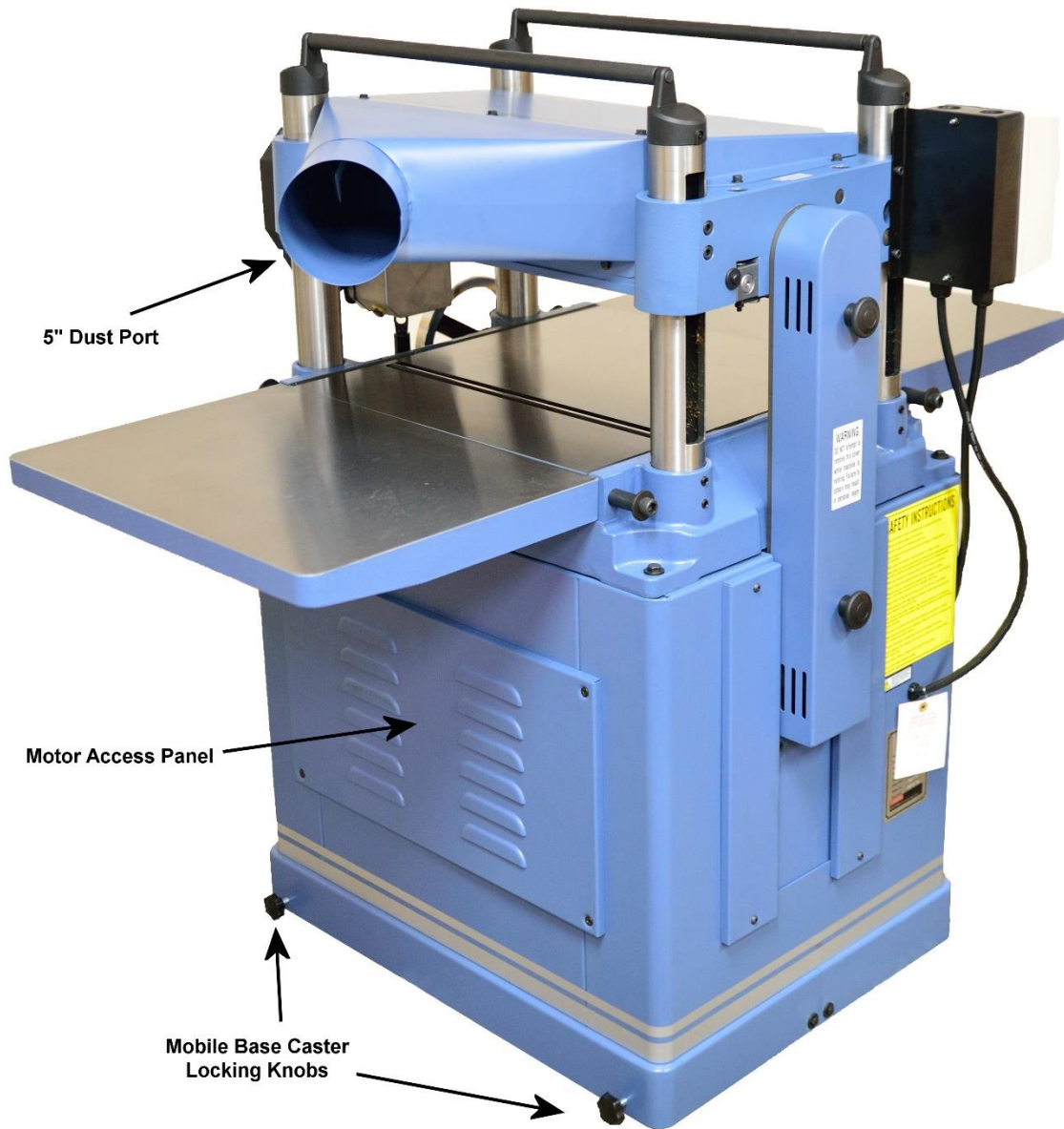



Safety

Oliver Machinery has made every attempt to provide a safe, reliable, easy-to-use piece of machinery. Safety, however, is ultimately depending on the individual machine operator. **Before operating this machine, please become familiar with the following safety labels and guidelines.**

 DANGER	This indicates an imminently hazardous situation which, if not avoided, WILL cause death or serious injury.
 WARNING	This means if the warning is not taken seriously, it CAN cause death or serious injury.
 CAUTION	This means if the precaution is not taken, it MAY cause minor or moderate injury.
IMPORTANT	This is a tip for properly operating the machine to avoid machine damage.

General Safety Guidelines

1. **FAMILIARIZE** yourself with all safety instructions found in this manual. Know the limitations and hazards associated with this machine. Do not operate or service this machine until you are properly trained.
2. **ELECTRICAL GROUNDING**, when done properly, reduce the risk of electrocution, shocks, and fire. Make certain that the machine frame is electrically grounded and that a ground lead is included in the incoming electrical service. In cases where a cord and a plug are used, make certain that the grounding plug connects to a suitable ground. Follow the grounding procedure indicated in the electrical code of your area.
3. **DISCONNECT** the machine from power before performing any service, maintenance, or adjustments. A machine under repair should be RED TAGGED to show it should not be used until the repair is complete.
4. **EYE PROTECTION**: Always wear an approved safety face shield, goggles, or glasses that complies with ANSI Z87.1 and CSA Z94.3 standards. Common eyeglasses are not safety glasses, and may not provide adequate protection.
5. **EAR PROTECTION**: Use hearing protective devices where the noise exceeds the level of exposure allowed in Section 1910.95 of the OSHA Regulations. When in doubt, use it.
6. **OTHER PERSONAL PROTECTION**: Before starting the planer, remove tie, rings, watch, and other jewelry. Roll up sleeves above elbows. Remove all loose outer clothing and confine long hair. Protective footwear should be used. Do not wear gloves unless it is instructed to perform a particular step(s) in the manual.
7. **GUARDS**: Keep machine guards in place for all applicable operations. If any guards are removed for maintenance, DO NOT OPERATE the machine until all guards are reinstalled. Check clearance between the guards and the cutter before starting the machine.

8. **WORKPLACE SAFETY:** Keep the floor around the machine clean. Scrap material, sawdust, oil, and other liquids increase the risk of tripping or slipping. Be sure to clean up the table before starting the machine. Make certain the work area is well lighted and that a proper exhaust system is used to minimize dust. Use anti-skid floor strips on the floor area where the operator normally stands and mark off the machine work area. Provide adequate workspace around the machine.
9. **ACCESS CONTROL** should be enforced so only trained personnel can access the work area and operate the machine. Use childproof power switch when applicable.
10. **STAY ALERT** at all times. Do not operate this machine while under the influence of drugs/alcohol, or when not feeling well.
11. **REPLACEMENT PARTS:** Use only genuine Oliver Machinery replacement parts and accessories recommended for this machine. Generic parts made by other manufacturers may create a safety hazard and WILL void the factory warranty and other guarantees.
12. **PROPER USE:** Do not use this machine for anything other than its intended use. If used for other purposes, Oliver Machinery disclaims any real or implied warranty and holds itself harmless for any injury or damage which may result from that use.

Safety Guidelines Specific to Planer

Before Work Begins:

1. **USE ONLY NATURAL, SOLID WOOD.** Do not plane any material such as plywood, MDF, OSB, laminate, or anything that can disintegrate during operation. Do not plane treated lumber or anything that contains harmful chemicals, as this will spread wood dust that contains such harmful chemicals. Do not attempt to plane workpieces with loose knots or with any other foreign materials.
2. **CHECK CUTTER INSERTS:** Make sure cutter inserts are sharp, clean, and free from damages. Forcing dull/damaged cutter inserts to work invites accidents, and lowers the quality of the finish. Use the recommended amount of torque to securely fasten all inserts onto the cutterhead.
3. **SERVICING CUTTER INSERTS:** Wear heavy-duty leather gloves to protect your hands when installing new cutter inserts or rotating the existing ones. Ensure the cutterhead is thoroughly clean before installing the insert. Debris between the cutter insert and the platform can create uneven pressure, causing the insert to break, and body injuries may occur.
4. **SUPPORT LONG WORKPIECE** with auxiliary stock feeding rollers/tables. This will help to avoid injuries and improve the quality of the finish.

When Planning:

1. **DUST COLLECTION SYSTEM** is required for this planer. Please make sure the system is on and provide enough suction before work begins.
2. **KICKBACK** happens when a workpiece is ejected, usually towards the infeed side of the planer, during the operation. **This can cause serious injuries or even death.** This planer is equipped with metal anti-kickback fingers to reduce the risk of kickback. Make sure they are clean and moving freely before work begins. Even with this safety device installed, kickback can still happen due to workpiece quality, grain orientation, and many factors. The operator should be cautious about possible kickbacks.
 - **ALWAYS** wear proper protection devices and stay away from the line of fire to avoid kickback-related accidents.
 - **NEVER** look inside the planer during operation.
 - **NEVER** plane boards that are shorter than 7" as mentioned in the specifications.
3. **PROPER WORKPIECE FEEDING** avoids kickback. Never start the machine with the workpiece engaging the cutterhead. Never start feeding until the planer has reached its full speed. Ensure the feeding rollers grip firmly on the workpiece.
 - **NEVER** force a workpiece through the planer. Make adjustments as needed.
 - **ONLY** plane one board at a time.
 - For twisted workpieces, use a jointer to face joint the bottom side of the workpiece before planning.
4. **STUCK WORKPIECE** should be removed only after the planer is powered off, and the cutterhead comes to a complete stop. Do not use hands or push sticks to force-feed a workpiece through the planer, as it can result in severe injuries and/or machine damage.
5. **DEPTH OF CUT SETTINGS:** Never exceed the designed maximum depth of cut capacity found in the specification. Failing to comply can cause machine damage and injuries. Consider the hardness of the workpiece when setting the depth of cut, as harder wood types increase the workload of the planer.

After Operation

1. **STOP THE MACHINE** if the operator leaves the machine for any reason.
2. **WAIT** until the machine comes to a complete stop.
3. **CLEAN UP** the work area before departure.

Electricals



WARNING All electrical work must be done by a qualified electrician and must meet the electrical code in your area.

Minimum Circuit Size Required for Model 4430 Planer

Stock Number	Minimum Circuit Size Required
4430.201	30A

Please ensure the electrical circuit for this machine meets the minimum circuit size requirement. The minimum circuit size requirement applies to a dedicated circuit that provides power to one 4430 Planer. If more machines are sharing the same circuit, consult a qualified electrician to ensure the designated circuit is properly sized for safe operation.

If a circuit is available, but not meeting the minimum circuit size requirement listed above, a new circuit must be installed for this machine.

Grounding



WARNING Improper grounding can cause electric shock, fire, and equipment damage.

Proper grounding reduces the risk to the operator in the event of electrical malfunction or breakdown. This machine must be connected to the grounding conductor when available, and all grounding connections must meet or exceed the electrical code requirements in your area. Furthermore, all grounds must be verified and must meet or exceed the electrical requirement of the machine. If grounding is not available, consider the use of a GFCI protection device as an alternative, if this complies with the electric code in your area.

Electrical Wiring

This machine is not pre-wired with a plug. A 5-foot long 12AWG cord is provided for connecting this machine to a power source. If you plan to connect the machine directly to the electrical panel (“Hardwiring”). Please ensure there is a readily accessible electrical disconnect near the machine. Refer to the section “Wiring Diagram” for wiring your machine to a power source.





If you choose to connect this machine with a plug and a cord, please use a UL/CSA listed plug. If you need an extension cord to connect to the power outlet, select a durable cord type with a high-temperature rating (90C° or above). Both plug and power cord must be sized to meet the amperage requirement of your machine.

Minimum cord size (AWG) required based on amperage draw and length of the cord:

Amps	Power Cord Length				
	25 feet	50 feet	75 feet	100 feet	> 100 feet
< 5	16	14	14	14	NR
5 to 8	14	14	14	12	
8 to 12	14	14	12	10	
12 to 15	12	12	10	10	
15 to 20	10	10	10	NR	
21 to 30	10	NR	NR	NR	

*NR: Not Recommended

 WARNING	<p>Use properly sized wires that meet or exceed the power requirement of your machine. Using undersized wires may cause overheating and increase the risk of fire and machine damage.</p>
---	--

 WARNING	<p>Improper copper-aluminum wire connection is a fire hazard. If the power circuit available uses aluminum wires, use certified CU/AL wire connectors.</p>
---	---

Setup

Shop Preparation

Space Requirement

The dimensions of this machine are 51" (L) x 40" (W). You will need additional spaces for manipulating your workpiece, electrical connection, and dust collection.

Load Limits

This machine has a shipping weight of 625 lbs., and a net weight of 546 lbs. Please ensure all lifting tools and building structures have adequate load capacity, for transporting and supporting the total weight of this machine, the operator, and related items.

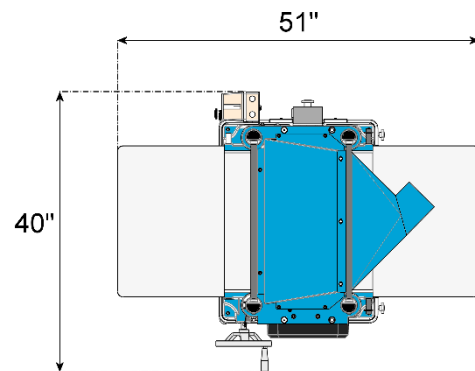

Electricals

Ensure a properly sized circuit and an electrical terminal are available nearby the machine. If the machine is to be hardwired, there must be a readily accessible power disconnect nearby, so that the machine can be disconnected from the power source for servicing and adjustments. If the machine is to be connected with a cord and a plug, please ensure a matching outlet is installed nearby the machine.

Please refer to section “Electricals” in this manual for details regarding electrical requirements.

Lighting

Adequate lighting is needed for operating this machine. Overhead, non-glare lighting should be installed.

Safety Labels

If this machine introduces a new safety hazard to your workplace, display proper warning signs in a highly visible location(s).

Dust Collection

Wood dust created by this planer is a health hazard. Connect a dust collection system to this machine. Check air suction regularly to ensure the pipes are not jammed.

Dust masks should be available for using the planer.

	CAUTION	Use a dust collection system that is rated above 650 CFM. Doing so improves air quality in the workplace, and protects the machine from jamming.
		Piping of dust collection system introduces additional air resistance and decreases the effective CFM measured at the dust ports. Ensure there is significant suction at the dust port, so dust and debris can be effectively removed from the machine.

Receiving

Your shipment should come with one wood crate. Upon receiving your shipment, check for any significant damages before signing the delivery confirmation.

IMPORTANT

If items are damaged, please call us immediately at **1-800-559-5065**



You may need to remove the strapping that is used for securing your package. Strapping may spring back violently when released and cause injury. Always wear safety goggles and gloves for this task.

Moving Machine into the Shop

Your machine will be delivered by freight service, and it will be left outside of your workshop by default. On the day of delivery, please be sure help is available to move the machine to its final location.



4430 Planer has a gross weight of 625 lbs. and a net weight of 546 lbs.

Safe moving techniques and proper lifting equipment are required, or serious personal injury may occur.



Your shipment may be secured by the straps. Do not lift your shipment by the strap. They are not designed to hold the total weight of your shipment. They may snap without warning and cause serious injury and machine damage.

Unboxing

Upon removing the crate cover, you should find a planer that is mostly assembled, and three paper boxes that contain all loose parts and accessories. Everything is covered by a plastic bag.



Inventory

Carefully unwrap the packaging and make sure all components are included in the shipment. Lay out all items received and inventory them.

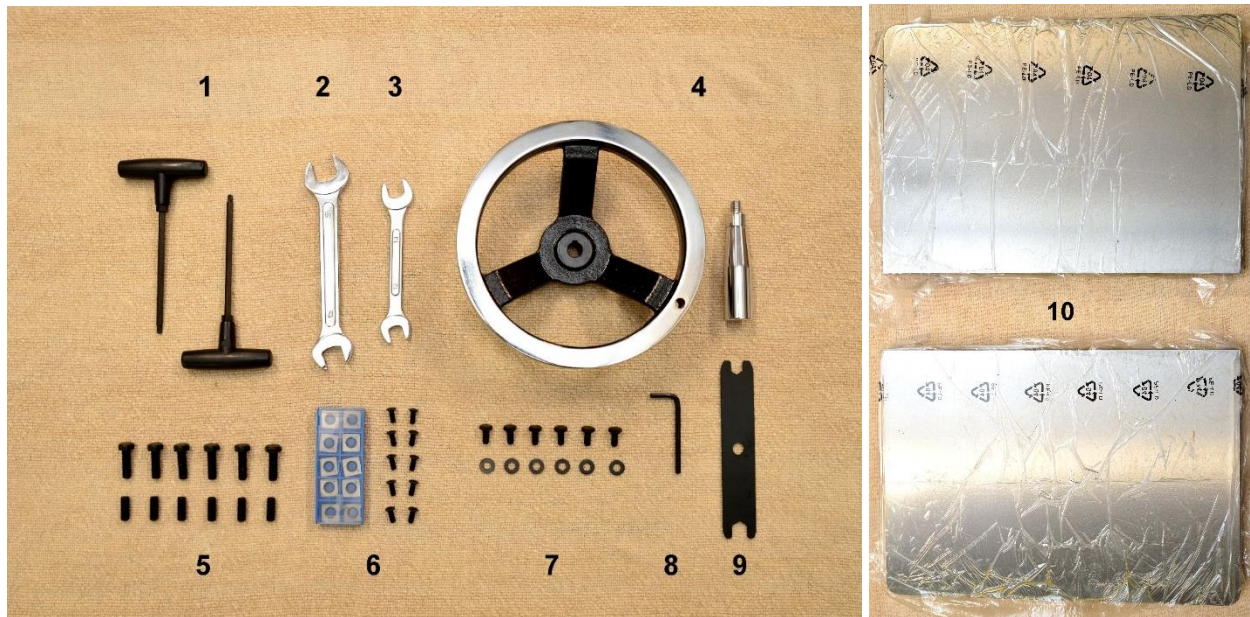

Item	Description	Quantity
1	T-Handle Torx Drivers (T-25)	2
2	17/19mm Wrench	1
3	12/14mm Wrench	1
4	Height Adjustment Handwheel and Handle	1
5	Fasteners for Extension Table: Hex Bolt (M8*1.25P*25) Set Screw (M8*1.25P*20)	6 each
6	Spare Cutter Inserts and Torx Screws	10 each
7	Fasteners for Dust Hood: Socket Head Cap Screw (M6*1.0P*12) Washer	6 each
8	4mm Hex Wrench	1
9	10/13mm Wrench	1
10	Cast Iron Extension Tables	2
11	5" Dust Hood (Not shown in the picture)	1

NOTICE: If you cannot find the item in the list above, please check if they are still attached to the packaging or inside the cabinet. Occasionally the item may have been pre-installed at the factory. Please refer to the parts list section in this manual to ensure you have all the components to set up this machine.

NOTICE: This machine comes with various standard sized, non-proprietary parts. If any of these parts are missing, we are happy to deliver them to you. To have the machine up and running as soon as possible, you can also find these parts at your local hardware store.

Additional Items Recommended for Machine Assembly

<i>Item</i>	<i>Purpose</i>
Safety Glasses	Protection
Disposable Gloves	Protection
Paper Towel / Rags	Cleaning
Rust Inhibitor	Cast iron table top rust protection.
Straight edge	Check alignments.
Metric Combination Wrench Set	Assembly and Maintenance
Metric Hex Wrench Set	Assembly and Maintenance
Torque Wrench	Cutter inserts installation and for checking Torx screw tension (50-55 lbs.-inch).
T25 Star Bit Socket	Cutter inserts installation.

Removing Machine from Crate

When all items are ready for setting up the machine, gently remove the machine from the pallet. The planer is equipped with casters so it can be pushed off the pallet with the help of a ramp.

The base of the planer is bolted onto the pallet to prevent shifting during transport. Remove these screws and brackets if you see them. You may reuse the hardware if the machine is to be bolted onto the floor.



If more lifting is needed, you may attach a pair of 1" lifting slings to all 4 of the lifting points located on the side of the planer. Be careful with the power switch and the digital readout when lifting the machine with lifting devices.

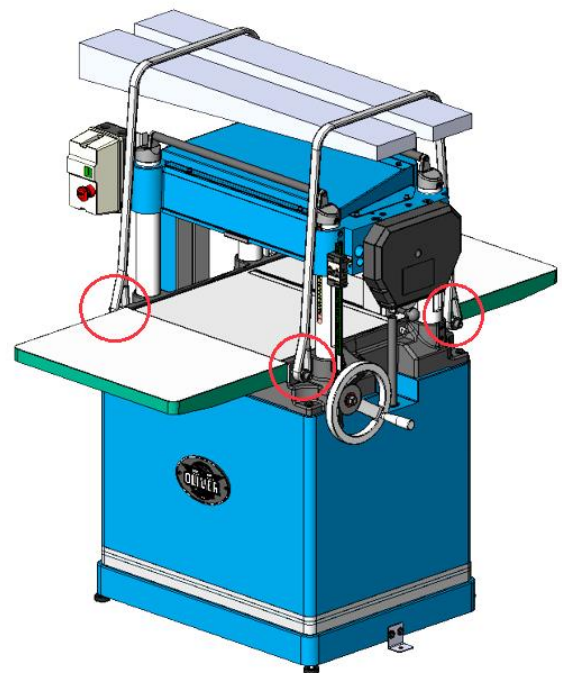

	<p>WARNING 4430 Planer has a net weight of 546 lbs. All lifting devices must be capable to handle the load, or serious personal injury and machine damage may occur.</p>
---	---

Cleaning

To prevent rusting, the cast iron bed and extension tables of this planer are covered with machine oil and plastic film. Remove the plastic film, then wipe off the machine oil with paper towels or rags.

Once all the machine oil is removed, routinely coat the unpainted cast iron surface with rust preventive such as Boeshield® T-9 or paste wax. Do not use rust preventives that contain silicone, which is known to interfere with certain finishes and glues.

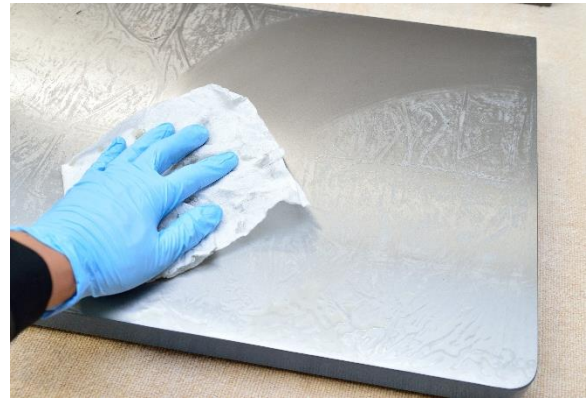

Assembly

This planer is mostly assembled in the factory. There are a few more items to set up before the machine is ready for a test run:

1. Install height adjustment handwheel.
2. Install the dust hood.
3. Install extension tables.
4. Install the power switch.
5. Connect planer to a dust collection system.
6. Connect the planer to a power source.

The approximate time for cleaning and assembly is approximately 60 minutes.

Installing Height Adjustment Handwheel

1. To install the height adjustment handwheel, you will need the key, the bolt, and the washer. They are taped onto the handwheel shaft. Carefully remove the tape to retrieve these parts.

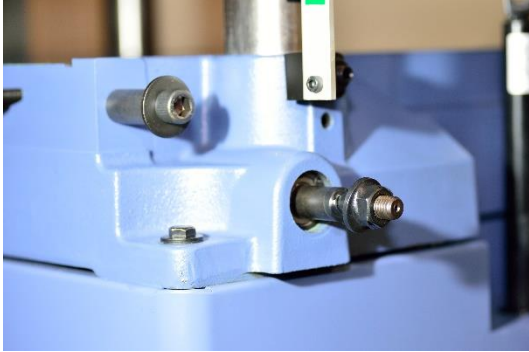

3. Insert the key into the keyway on the handwheel shaft.
4. Insert the handwheel and make sure the keyway on the handwheel is aligned with the key.



2. Install the handle of the handwheel and tighten it with a 14mm wrench.



5. Install the washer and nut, then tighten the nut with a 19mm wrench.



Installing Dust Hood

Use the provided cap screws and washer (#7 in "Inventory"), to mount the dust hood on top of the cutterhead cover:

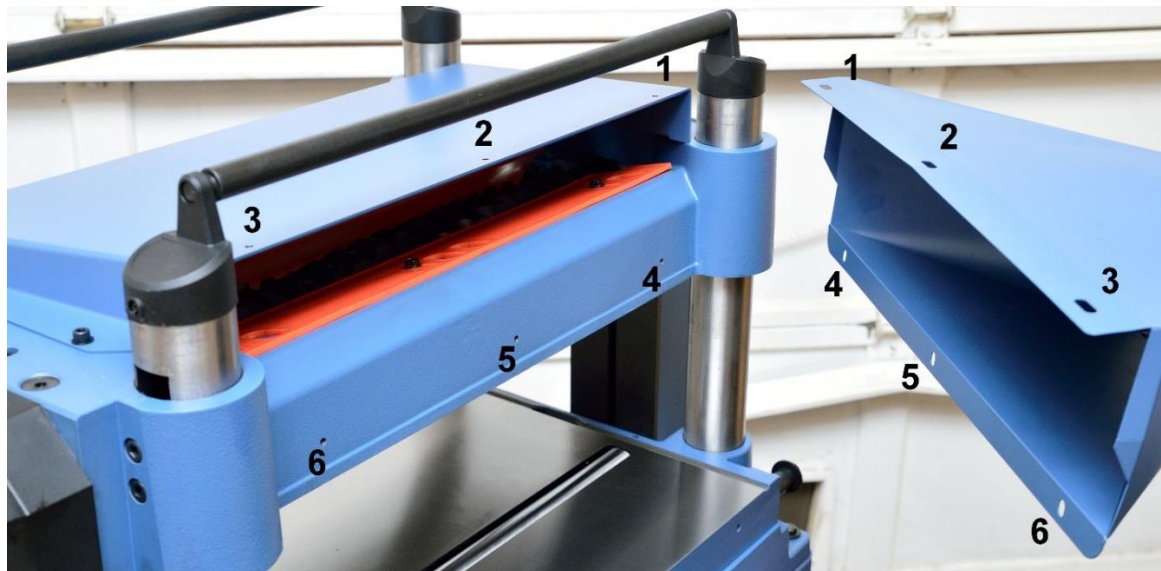

Installing Extension Tables



Each extension table weighs 29 lbs. and it can be difficult to install by one person. Get assistance to install the extension tables when needed.

1. Attach the extension table to the planer with the provided mounting bolts (#5 in "Inventory"). Do not fully tighten the bolts yet. Just make sure it is tight enough to hold the extension table in place. Then hand thread the set screws into the extension table.

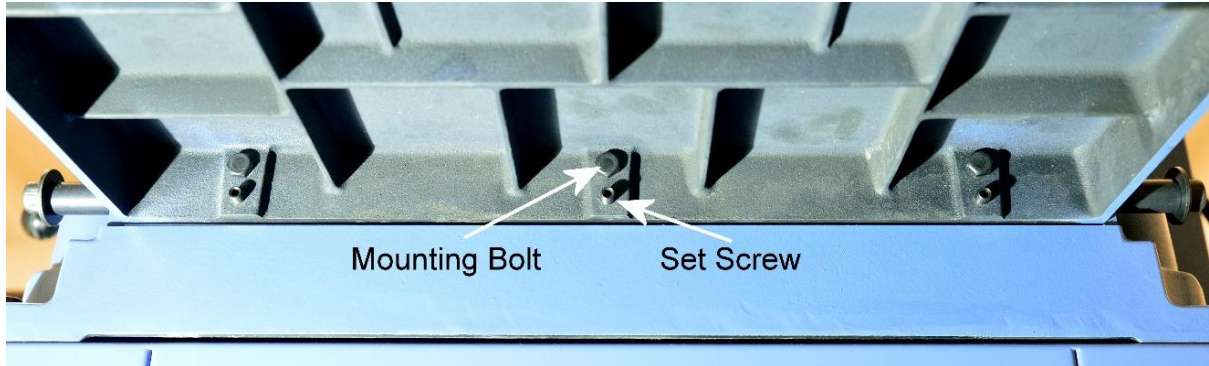

2. Align the edge of extension tables with the edge of the planer bed. Make sure the edges are flush with each other.

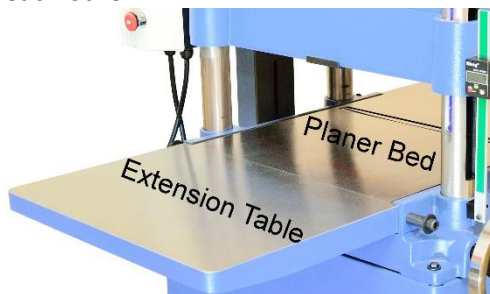

3. Use a straight edge to check if the extension tables are in parallel with the planer bed. At this point, the extension table should sag slightly.

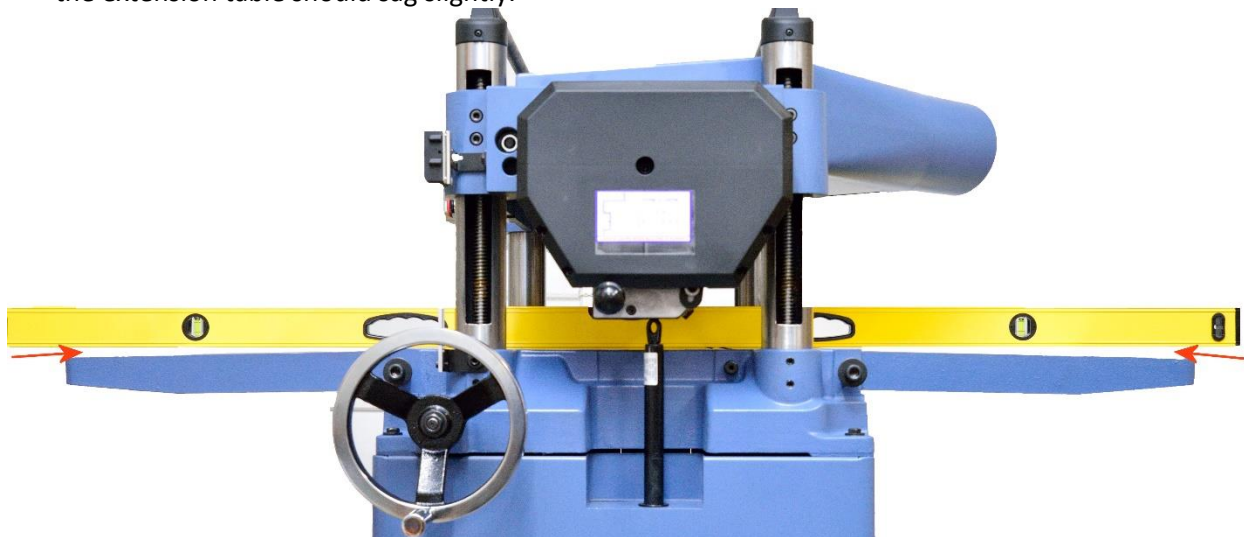

4. Rotate the set screws with a hex wrench to raise the extension tables. For each set screw, make small, incremental adjustments, and then move on to the next set screw. Repeat until both extension tables are in parallel with the planer bed. If a set screw becomes too difficult to turn, you may need to slightly loosen the mounting bolts before continue to raise the extension table.

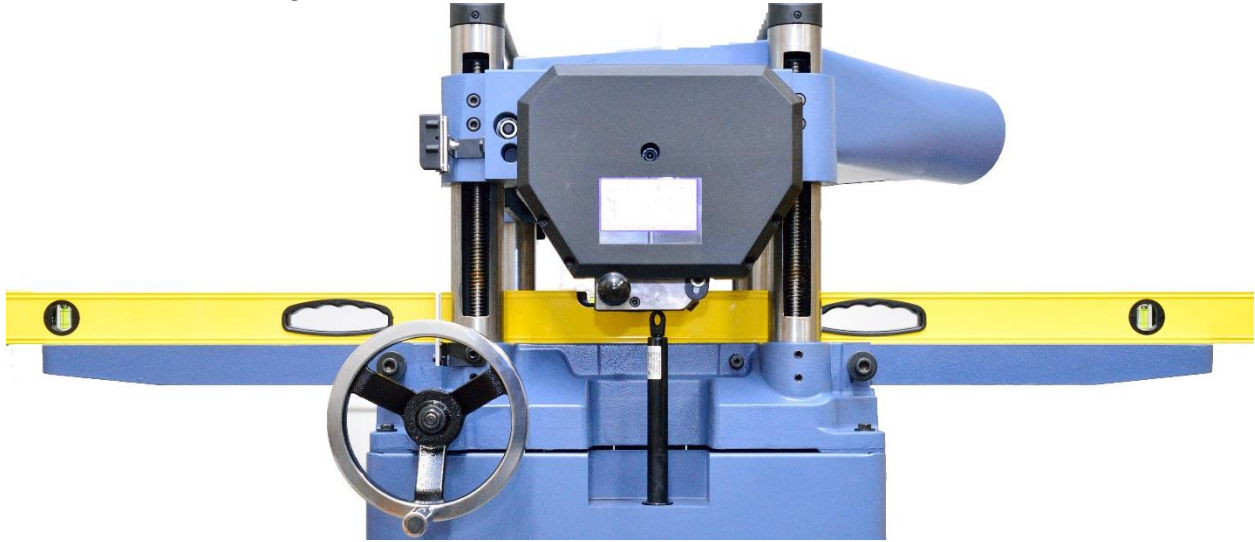

5. When the extension tables are in parallel with the planer bed, tighten all mounting bolts. Recheck table parallelism for one more time.
6. Save these instructions as the extension tables will need to be adjusted from time to time.

Installing Power Switch

The mounting screws for the power switch are pre-installed in the headstock. Remove the cap screws as shown in the picture, then use them to mount the power switch.

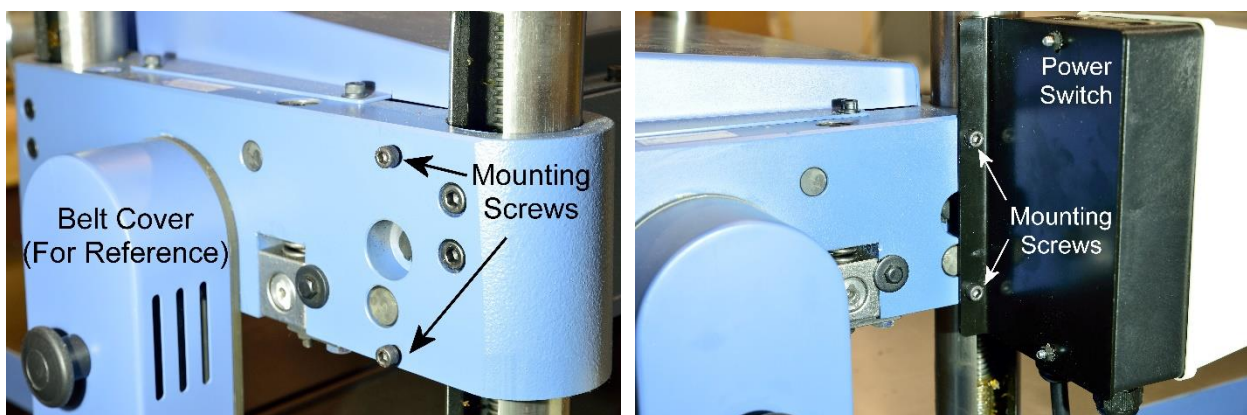

Dust Collection

This wood planer can generate a lot of wood shavings and dust. Connect a dust collection system to this machine. The minimum CFM requirement for this planer is 650 CFM at the dust port, which means your dust collection system should have a rating greater than 650 CFM, as air friction from the ducts reduces the effective CFM at the dust ports.

IMPORTANT

Running this planer without a dust collection system, or using a dust collection system with inadequate suction, will cause dust and shavings to accumulate inside the planer. This can damage the machine and cause other hazardous situations. Check your dust collection system regularly to make sure it is not jammed or filled up.

Wiring and Grounding



Deenergize the electrical circuit before touching any enclosed, electrified parts. Touching an electrified part WILL result in serious personal injury or death.



All electrical work must be done by a qualified electrician and must meet the electrical code in your area.

Make sure the voltage of your power circuit matches the power requirement of this machine, and the circuit is sized to supply power to the planer.

Wiring Instructions

This machine is not pre-wired with a plug. A 5-foot long 12AWG cord is provided for connecting this machine to a power source. If you plan to connect the machine directly to the electrical panel (“Hardwiring”). Please ensure there is a readily accessible electrical disconnect near the machine. Refer to the section “Wiring Diagram” for wiring your machine to a power source.

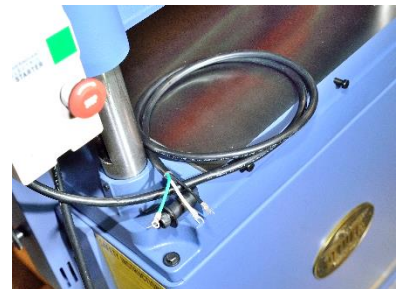

If you choose to connect this machine with a plug and a cord, please use a UL/CSA listed plug that is sized to meet the amperage requirement of your machine.

Break-in Period

Congratulations! This machine is now assembled and is ready for a test run! Please set a reminder to service this machine as it goes through the break-in period. Completing these services will maximize the performance and longevity of your machine.

After 16 hours of operation: Adjust V-belt tension.

After 50 hours of operation: Replace gearbox oil.

Controls and Components

ON / OFF Switches

*To Turn Off
Machine*

Press the "STOP" button.

NOTICE: When the STOP button is pressed, it needs to be reset before the planer can start again. To reset, rotate the serrated rim clockwise. The STOP button will pop up when it is reset.

NOTICE: The planer will shut down if it is overloaded. Press STOP to reset overload protection.

*To Turn On
Machine*

Press the green "START" button.

NOTICE: The machine will only start when the STOP button is reset.



Cutterhead Height Adjustment

The cutterhead height adjustment handwheel is located on the side of the planer, right below the digital readout.

Turn **CLOCKWISE** to lower the cutterhead.

Turn **COUNTERCLOCKWISE** to raise the cutterhead.

Each rotation of the handwheel changes the height by approximately 1/16" (1.5mm).

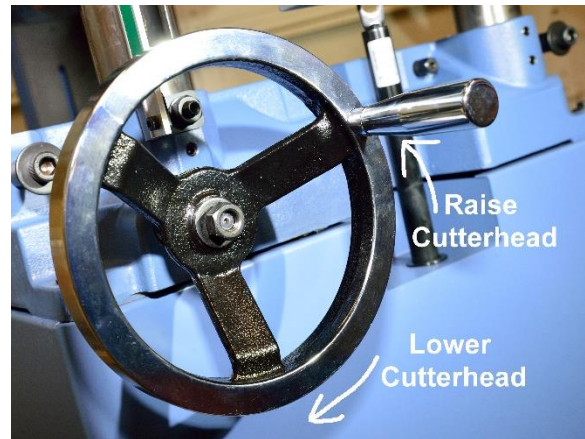

Cutterhead Height Scale

The cutterhead height scale is located on the right column next to the digital readout. A metal pointer marks the current height of the cutterhead.

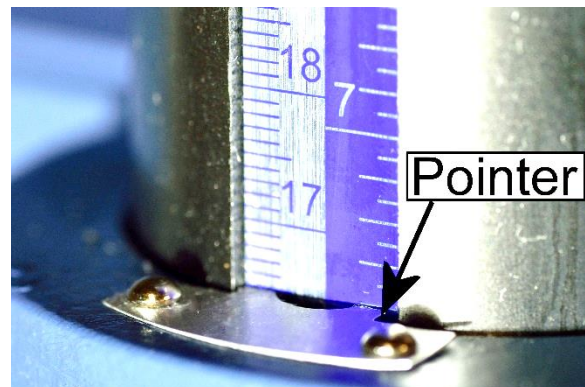

Digital Readout (DRO)

The Wixey DRO allows operators to measure the depth of the cut with 1/32" resolution.

- Press the **ON/OFF** button to turn on/off the DRO.
- Press the **MM/IN** button to toggle the measuring unit between metric (mm) and US standard (inch). The fraction inch value will appear if the measurement is a multiple of 1/32"
- Press the **ABS/INC** button to toggle between absolute measuring mode and incremental mode.
- Value in INC mode will be reset when switching to ABS mode.
- To reset the reading to zero in ABS mode, hold the ON/OFF button



Feed Rate Control

4430 Planer can feed stock at 16/20 FPM (feet-per-minute). To change the feed rate, shift the position of the feed rate control knob when the machine is running at full speed with no load:

- Push in: 20 FPM
- Pull out: 16 FPM
- In-between: 0 FPM (Neutral)

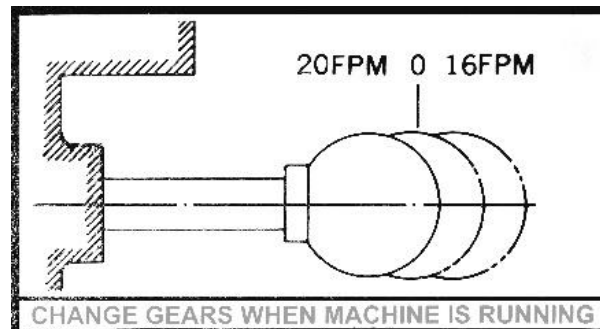
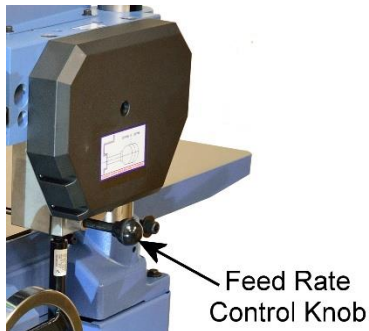

IMPORTANT

Only change the feed rate when the machine is running at full speed. Failure to do so may cause the gearbox to jam and damage the machine.

Components for Planing Wood

This diagram shows the components involved in planing a piece of wood:

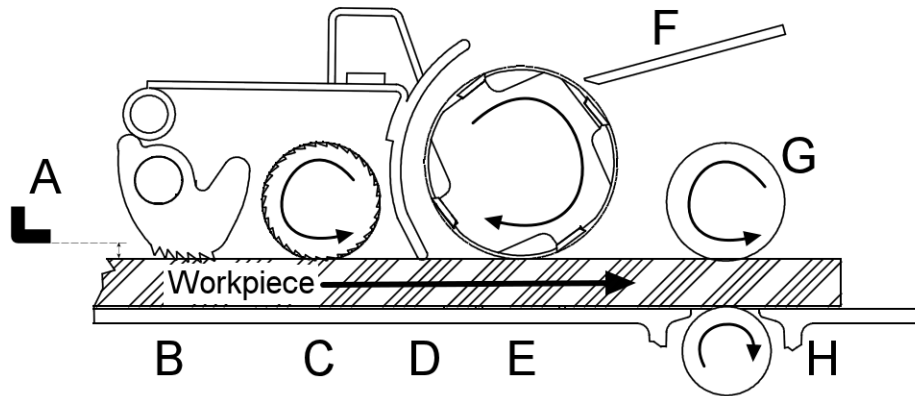

How it works:

1. When a workpiece enters the planer, with the planer's depth of cut properly set, it will clear the depth limiter **[A]**. For workpieces less than 8", it is possible to bypass the limiter and receive a deeper cut.
2. The anti-kickback fingers **[B]** then engage the workpiece to prevent accidental kickback.
3. As the workpiece moves further into the planer, it will engage the infeed roller **[C]**. The infeed roller will bring the workpiece towards the chip breaker **[D]** and the cutterhead **[E]**.
4. As the cutterhead cuts on the workpiece, the woodchips will be broken down by the chip breaker.
5. The chip breaker and the chip deflector **[F]** then divert the woodchips towards the dust port for removal.
6. As the workpiece leaves the cutter head, it will engage the outfeed roller **[G]**, which helps to pull the workpiece away from the planer.
7. The workpiece will also engage the bed roller **[H]** which helps reduce resistance as the workpiece moves along the planer table. The height of the bed roller can be adjusted to accommodate workpieces with various roughness.

Test Run

Each planer has been inspected and calibrated before leaving the factory to meet our quality and precision standards. Due to various reasons, the machine may need to be re-adjusted when it arrives at your workshop. It is recommended to complete the test run before using the planer for production work, and repeat the test run if the planer is relocated.

Step 1: Verify all electrical components are functional.

1. Remove all tools and debris from the machine.
2. Press the STOP button.
3. Connect the machine to the power source.
4. Turn the rim of the STOP button clockwise to reset the safety shutoff mechanism.
5. Press the green START button. The machine should be running with no excessive noise and vibration.
6. Press the STOP button to turn the machine off.
7. Without resetting the STOP button, attempt to restart the machine by pressing the START button. The machine should **NOT** start.
8. Reset the STOP button to restart the machine. Disconnect the machine from the power source while the machine is running, then reconnect the machine to power. The machine should **NOT** restart.

Step 2: Verify the planer headstock is functional and calibrated.

1. Connect planer to a dust collection system.
2. Lower the headstock all the way down. The headstock should stop at approximately 1/4" above the planer table.
3. Raise the headstock all the way up. Ensure all the anti-kickback fingers can move freely.
4. Turn on the DRO and verify its readings reflect the movements of the headstock.
5. Prepare a piece of good quality, straight grain wood board with a flat bottom for a test run. It is advised to choose a board that is close to 20" wide and at least 2 feet long.
6. Start the dust collection system.
7. Lower the headstock to remove 1/16" of the workpiece for the test run.
8. Turn on the planer and gently feed the workpiece towards the infeed roller. Once the infeed roller engages the workpiece, it should pull the workpiece through the planer. Verify the entire top surface has been cut.
9. Inspect the workpiece for defective finish.
10. Use a caliper to measure the thickness of each side to ensure the cutterhead is parallel with the planer table. If the thicknesses are the same, check if the reading is the same as shown on the headstock height scale.
11. Check for excessive snipes. A minimum amount of snipe may occur at the ends of the board, and it is expected.
12. While the machine is running idle, move the feed rate control knob to change the feed rate. This ensures the gearbox and feed rate control knob is functional.
- 13. Hit STOP to turn off the planer after testing.**

Congratulations! This planer has completed the test run and is ready for production work. If you discover any issues from the tests, please refer to the troubleshooting section and maintenance section for how to diagnose the issue and make adjustments.

Operation

For safety and best results, please take the following steps for operating this machine.

Step 1: Preparation

Only Use Natural, Good Quality Wood

Only plane natural, good quality wood materials. Cracked stock, board with loose knots, plywood, and other engineered wood products can break apart and cause severe kickbacks, which can lead to severe injuries and machine damages.

Do not plane treated lumber or anything that contains harmful chemicals, as this will spread wood dust that contains such harmful chemicals. NEVER plane boards that are shorter than 7" as mentioned in the specifications.

Inspect the Workpiece

Carefully inspect workpieces for foreign objects. Nails, staples, rock chips, and other objects embedded on the wood surface will damage the planer. To avoid chipping/dulling the cutter inserts, it is advised to clean a workpiece with a stiff brush to remove all dirt and foreign objects before planing, especially for rough sawn or reclaimed lumber. Use a metal detector to scan for metal objects as needed.

Check Moisture Content

Check the moisture content of the workpiece before work begins. "Green wood" with moisture content over 20% will not cut properly and may jam the machine. Excessive moisture content will also cause the planer's unpainted surface to rust. Besides, as the workpiece dries, the once-flattened surface can become fuzzy and warped again. It is recommended to allow the workpiece to dry and stabilize before it is processed.

Warped Stock

The workpiece should have a flat bottom to be processed by a planer. It is acceptable to process a slightly cupped board with the cupped side facing down and begin with light cuts. Boards with moderate cupping, bowing, or twisting should have one side face-jointed before being processed by a planer.

Avoid using boards with severe warping, as they can be unstable and might cause severe kickbacks during operation.

Glue-Ups

Glue left on the workpiece surface can dull the cutters and reduce cut quality. Scrape off all glue deposits from the workpiece before the work begins.

Wood Grain Direction

This planer is designed to plane WITH the grain direction of the wood. Do not plane cross-grain or end-grain. Severe kickback and chipping may occur.

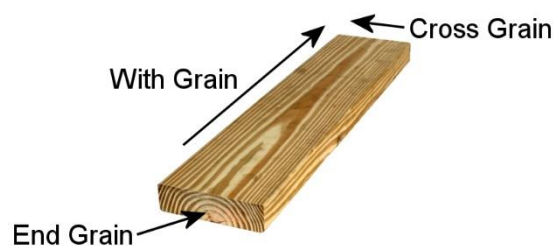

Step 2: Setting Depth of Cut and Feed Rate

This planer is capable of removing at most 1/8" per pass. For stocks that are less than 8" wide, the planer can cut as much as 1/4" per pass. For best results, it is recommended to take light passes with a low feed rate when approaching the desired thickness.

Wood Hardness

Depending on the hardness and brittleness of the wood type, the operator should adjust the maximum depth of cut and feed rate accordingly. For workpiece that is hard/brittle, reduce the depth of cut and feed rate.

For your reference, this Janka scale shows the hardness of wood types that are commonly used. It ranks the hardness of various wood types by measuring the amount of force (in lbs.) required to embed a 0.444" steel ball halfway into the wood.

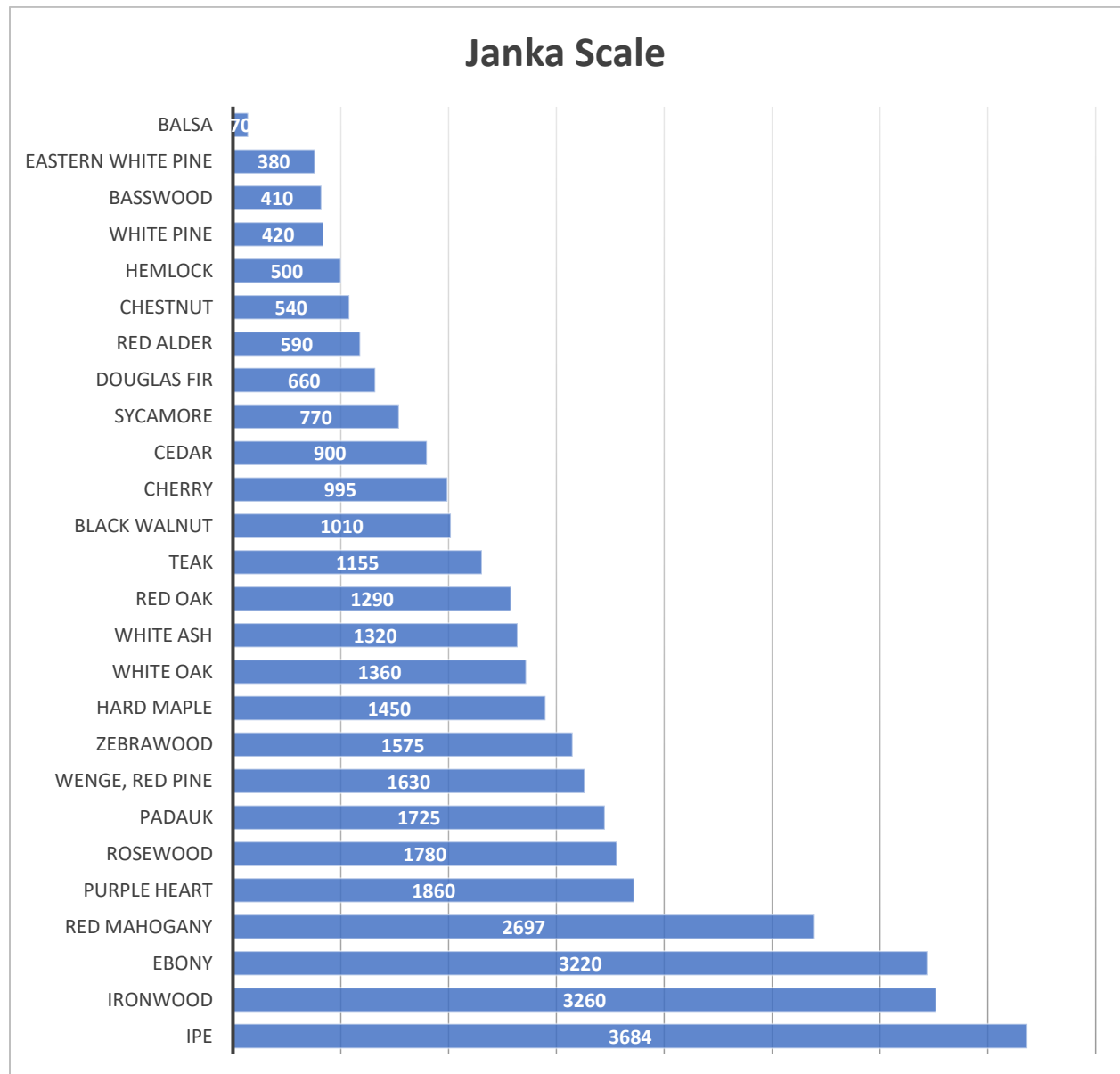

Step 3: Select Feed Direction

Inspect the workpiece and identify the direction of the edge grain. Choose a feed direction such that the workpiece will receive a downhill cut.

Good – Planer Cuts Downhill

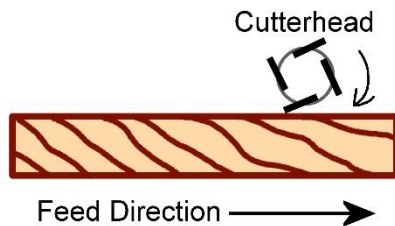

Not Ideal – Planer Cuts Uphill

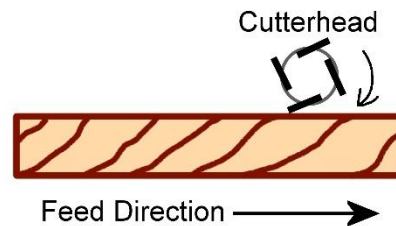

Sometimes it is impossible to perform a downhill cut for the entire length of a workpiece. In this case, try feeding the workpiece in opposite direction and see what works best. Reducing the depth of cut and feed rate can also help improve cut quality.

Step 4: Planing Wood to Desired Thickness



WARNING

ALWAYS wear goggles, and other protection devices when operating this machine. Stay on the side of the planer next to the power switch to avoid kickback related accidents. NEVER look inside the planer during operation. Failing to comply may result in serious injuries or death.



CAUTION

Use an ear protection device to prevent hearing loss. Ensure the dust collection system is functional and use a dusk mask to avoid inhaling harmful airborne particles.

With the above preparation steps completed, the workpiece is ready for planing.

1. Please put on all protection devices before starting the planer. If you have a long workpiece, please make sure it is properly supported throughout the process.
2. Measure the thickness/height of the workpiece, then move the cutterhead no more than 1/16" below the highest/thickest point of the workpiece. This allows the feed rollers to properly engage the workpiece, and at the same time not taking too much material off for a test pass.
3. Turn on the dust collection system and the planer.
4. While standing on the side of the planer, place the workpiece on the table with the flat side down. Gently feed the workpiece towards the infeed roller. Once the infeed roller engages the workpiece, allow the machine to feed the workpiece. **DO NOT** force feed the workpiece through the planer.

If the infeed roller does not engage the workpiece:

- Headstock height is set too high.
- Stop the machine. Wait for the machine to come to a complete stop.
- Raise the headstock and remove the workpiece.
- Reduce headstock height, and restart from step 3.

If the machine stalls or the workpiece gets stuck:

- Headstock height is set too low.
 - Stop the machine and wait for the machine to come to a complete stop.
 - Raise the headstock and remove the workpiece.
 - Reduce the depth of cut, and restart from step 3.
5. If the workpiece is feeding properly, wait until the entire workpiece clears the outfeed roller, then remove the workpiece.
 6. After the initial pass, measure the thickness at the midsection of the workpiece.

If more material needs to be removed, continue with the following steps.

7. If you need to remove a lot of material, run a few passes with deeper cuts, then finish with a light pass with shallow cuts and a low feed rate.
8. Turn on the digital readout (DRO), and use the INC mode to measure the depth of cut for each pass. If your DRO is already running in INC mode, you can reset the readings by switching to ABS mode and then come back to INC mode.
9. Using the DRO as a depth gauge, lower the cutterhead. Each pass should remove no more than 1/8" for workpiece wider than 8", and no more than 1/4" for workpieces 8" wide or less. Reduce the maximum depth of cut for harder wood types.
10. Upon completion of each pass, reset the reading of DRO. Use a caliper to measure the workpiece's mid-section thickness, and decide the depth of cut for the next pass.
11. Repeat the process until the desired thickness is achieved.

Turn the machine off when the operation completes.

Common Cutting Problems

Snipe

When a workpiece is not properly supported as it enters or leaves the machine, the ends of the workpiece will have more materials removed than the rest of the section. To mitigate this problem, hold the workpiece up slightly as it enters and leaves the machine. Sometimes, a small amount of snipe is inevitable, and the best way to fully eliminate sniping is to prepare a workpiece with extra length, and then trim the ends when planing is done.



Chipping

Happens when cutting against the grain direction. See “Uphill” cut in Step 3 of this section. For highly figured lumber and areas near a knot, some amount of chipping is normal. In this case, moistening the problematic area before planing can sometimes mitigate the issue.

Chipping can also be caused by dirty or dull cutters. If chipping happens while planing straight grain stocks, inspect the cutter inserts and remove all resin buildups. Rotate/replace dull cutter inserts when they are dull.



Indentation

This can happen when a foreign object is pressed on the workpiece when it passes through the planer. Remove all resin buildups from the rollers, the cutterhead, and the table. Also, check the dust collection system and ensure all wood chips generated are effectively removed. Adjust the chip breaker and chip deflector as needed.

Fuzzy Grain

Can happen when planing wood with high moisture content or if the cutter is dull. Sometimes this is unavoidable due to the nature of certain wood types. To mitigate this issue, avoid using wood with high moisture content and use sharp cutters.

Accessories

Oliver Machinery has a collection of accessories and add-ons to enhance the productivity of your planer. To purchase these items, please call us at **1-800-559-5065**, our representatives are available Monday through Friday, 7:30 AM - 4 PM Pacific Time.

You may also purchase them online: WWW.OLIVERMACHINERY.NET/ACCESSORIES or
E-mail our parts department: PARTS@OLIVERMACHINERY.NET



WARNING

Using unapproved accessories may cause the machine to malfunction, resulting in serious injury and/or machine damage. Only use accessories recommended for this machine.

Cutter Inserts



Genuine four-sided indexable carbide cutter insert that will fit the cutterhead of Oliver 4430 Planer.

Parts number: **P-15mm 4S**

Touchup Paint



Keeping all painted surfaces in good condition keeps your machine looking nice and prevents rusting. We have pre-mixed spray paint available in Oliver-Blue for purchase.

Please visit our website at WWW.OLIVERMACHINERY.NET/ACCESSORIES for other recommended accessories.

Maintenance

Routine maintenance keeps your planer in top shape. Please follow the maintenance schedule below, and use the maintenance record worksheet attached in the back of the manual to document all tasks completed. **NOTICE:** Maintenance schedule may vary for individual users due to different situations and safety requirements.

 WARNING	Disconnect the machine from the power source before any maintenance work is performed. After servicing the planer, remove all wrenches and tools before restarting the machine. Failure to comply can cause serious injury!
---	--

Maintenance Schedule

Interval	Component
Every day	Remove dust buildups from the planer and dust collection system.
	Inspect the power cord for signs of aging and damages. Replace as needed.
Every week	Inspect and clean cutterhead, rollers, and anti-kickback fingers. Remove any dust and resin accumulation.
	Inspect/rotate/replace worn cutter inserts.
	Apply rust protectant on unpainted cast iron surfaces.
	Verify extension tables are level with the planer bed. Adjust as needed.
Every month	Check V-belt tension and replace if the belt shows signs of cracking or glazing.
Every 4-6 months	Remove dust buildups from the motor and the cabinet.
	Inspect headstock chain for chain slacks.
	Check parallelism between the table and cutterhead, and the rollers.

Notice: Motor bearings are permanently sealed and lubricated, and do not require lubrication.

Lubrication Schedule

Component	Interval	Types of Lubricant	Reference
A - Return roller shafts	Every week	SAE 30 oil.	Figure 1
B - Feed roller shafts	Every 30 hours	SAE-30 oil.	
C - Drive chains and sprockets	Monthly	General purpose grease	Figure 2
D - Lead screws (x4)	Once every 3 months	General purpose grease	
E - Columns (x4)	Clean and lubricate weekly	A light coat of SAE-30 oil	
F - Gearbox	Replace gearbox oil after the first 50 hours of use, then replace the oil every year.	Standard gear oil, 70-90 weight. Remove gearbox cover to access drain plug and fill plug. Drain and recycle used oil. Refill oil until it reaches the fill plug.	Figure 3
G - Outfeed roller	Clean and lubricate as needed.	A very light coat of SAE-30 oil.	Figure 4
H - Infeed roller			
I - Anti-kickback fingers			
J - Bed roller			Figure 5
K - Headstock chain and sprockets	Every 4 to 6 months	Grease, or good quality cycle chain lubricant. Remove the motor access panel to access components.	Figure 6

Figure 1

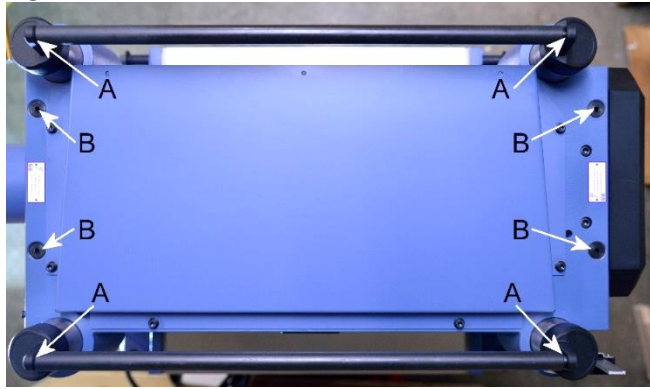

Figure 2

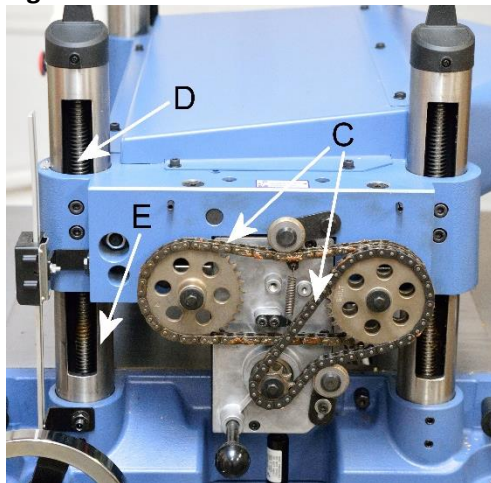

Figure 3

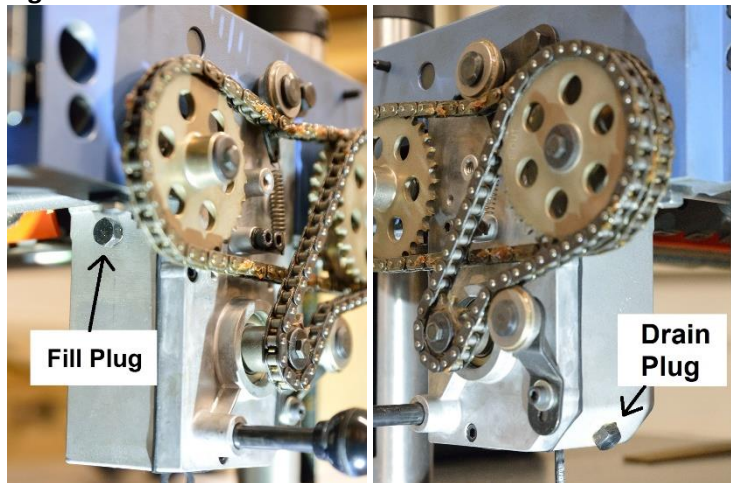

Figure 4

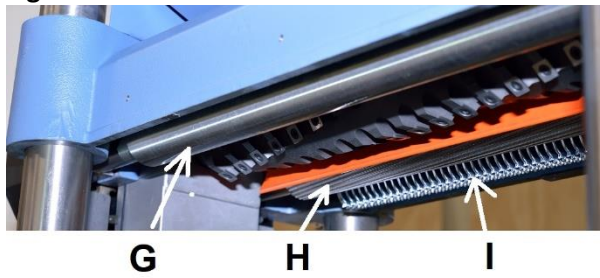

Figure 5

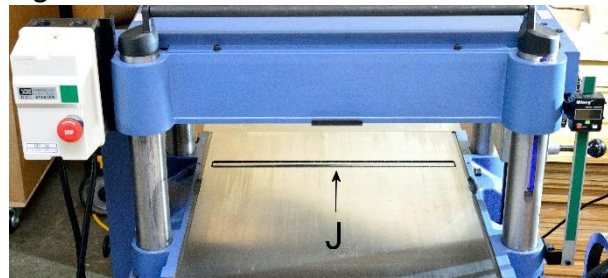
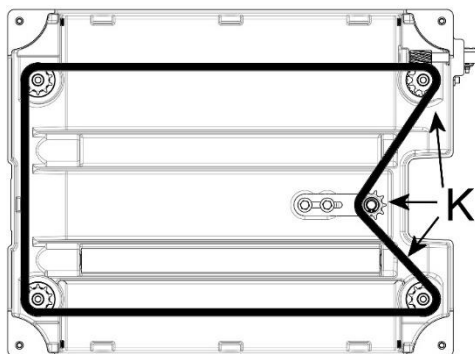

Figure 6





Disconnect the machine from the power source before any maintenance work is performed. After servicing the planer, remove all wrenches and tools before restarting the machine. Failure to comply can cause serious injury!

Remove Planer Top Cover

This allows you to service the cutterhead, chip deflector, and chip breaker.

1. **Disconnect the planer from the power source!!**
2. Remove dust hood.

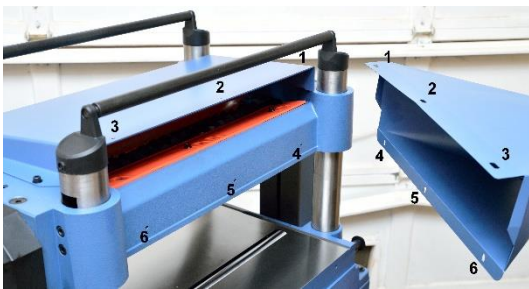

3. Remove the planer cover by removing the four cap screws from the top of the planer.

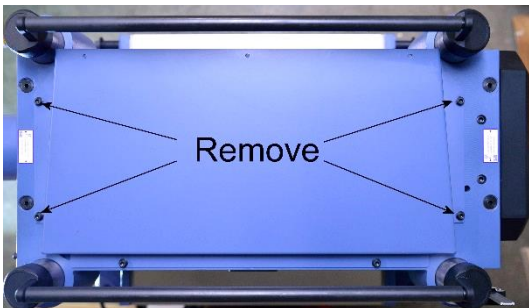

Adjust Chip Deflector Clearance

The chip deflector was pre-installed in the factory and should not require adjustments initially. If the gap between the chip deflector and cutterhead goes beyond the 1/16" - 1/8" tolerance, adjustment is needed.

1. **Disconnect the planer from the power source!!**
2. Remove dust hood and top cover.
3. Loosen the three bolts that secure the chip deflector.



4. Adjust the distance between the chip deflector and the cutterhead. The entire edge of the chip deflector should be no less than 1/16" away from the closest point of the cutter head, but no more than 1/8".

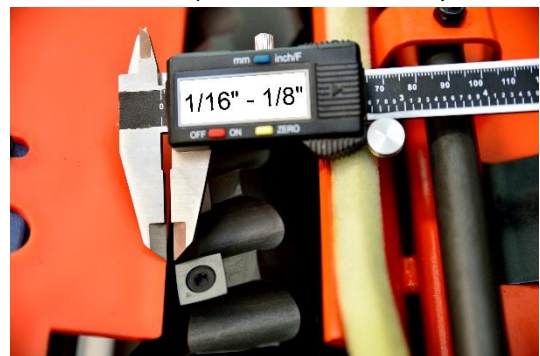

5. Re-tighten the bolts to secure the chip deflector, then reinstall the top cover and dust hood.
6. Remove all wrenches and tools before restarting the planer.

Service Cutterhead and Rotate Cutter Inserts



CAUTION

Cutter inserts on the cutterhead are extremely sharp. Protect your hands with thick leather gloves to avoid injuries.

1. **Disconnect the planer from the power source!!**
2. Remove dust hood and top cover.
3. Remove dust and resin accumulations on cutterhead and areas nearby.
4. Rotate cutter inserts 90° clockwise when they get dulled or nicked. Use a permanent marker to mark the new edge to be used.
5. To rotate/replace a cutter insert, remove the Torx screw with a T-25 Torx bit. Turn **COUNTERCLOCKWISE** to loosen the screw.



6. With the cutter insert removed from its platform, thoroughly clean the cutter insert platform with a vacuum or compressed air.



IMPORTANT: Obstacles between the insert and cutterhead platform will create uneven pressure against the insert. This will lower cut quality and may cause the insert to crack.

7. Reinstall the cutter insert with the marked cutting edge facing out.

8. Inspect the Torx screw. Replace any damaged screws. Lubricate screw thread with a thin coat of lightweight machine oil.

IMPORTANT: Do not use an excessive amount of lubrication, or the Torx screw and the cutter insert will not sit properly.

9. Using a torque wrench, re-tighten the Torx screw with 50-55 lbs.-inch of torque.

IMPORTANT: Do not overtighten the screw or the inserts may break. Do not use power tools to tighten the torx screws as it can strip the screws.

10. Reinstall the top cover and the dust hood when cutterhead service completes.
11. Remove all wrenches and tools before restarting the planer.

Adjust Belt Tension

⚠ CAUTION: Belt and pulleys may be hot after operations. Allow components to cool before servicing.

IMPORTANT: After the initial break-in period. The V-belt should stretch by some amount. Check and adjust belt tension after 16 hours of operation.

1. **Disconnect the planer from the power source!!**
2. Remove the belt cover knobs and the belt cover.

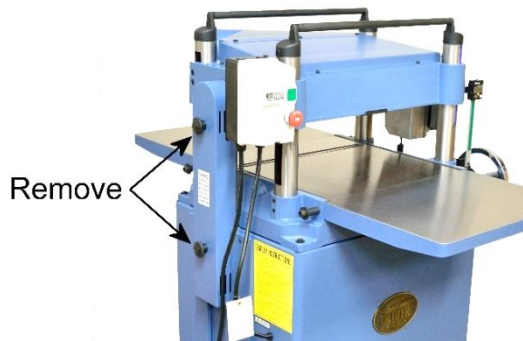

3. Apply moderate pressure on the V-belt midway between the two pulleys. Properly tensioned V-belt should deflect by approximately 1/4".

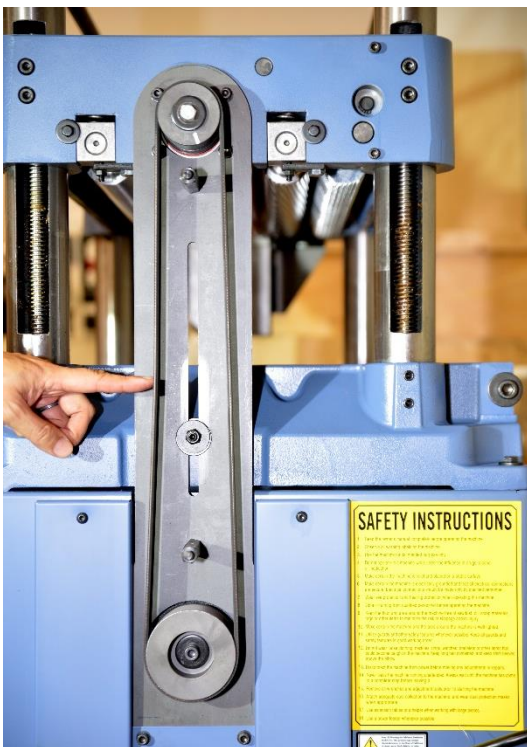

If belt tension needs adjustment:

4. Remove the side panels to gain access to the motor mount cap screws.



5. Loosen the cap screws and lower the motor to tighten the belt. If the belt becomes too tight, raise the motor.

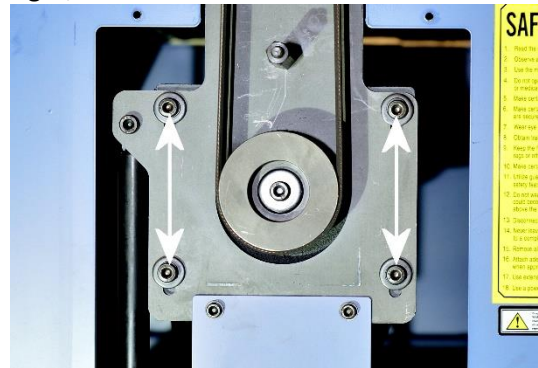

6. Re-tighten the motor mount cap screws and re-install the side panels when the belt is properly tensioned.

If the belt needs to be replaced

7. Loosen the belt and roll the belt off the pulleys.
8. Install new belts and make sure the belt sits in the grooves of the pulleys.
9. Adjust belt tension.
10. Set a reminder to readjust belt tension after the new belt is broken in. The process takes approximately 16 hours of run time.

When belt maintenance completes

11. Reinstall all the panels and covers.
12. Remove all wrenches and tools before restarting the planer.

Adjust Headstock Chain Tension

1. **Disconnect the planer from the power source!!**
2. Remove the motor access panel.

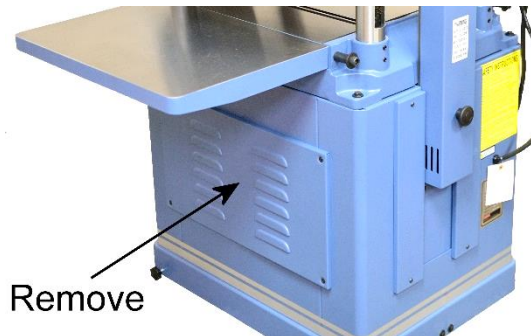

3. Loosen the two locking bolts for holding the chain tensioner bracket in place.

IMPORTANT: Keep the headstock chain tensioned while loosening the locking bolt. If the chain falls off from the sprockets, it can take a lot of time to reinstall the chain and recalibrate the planer.

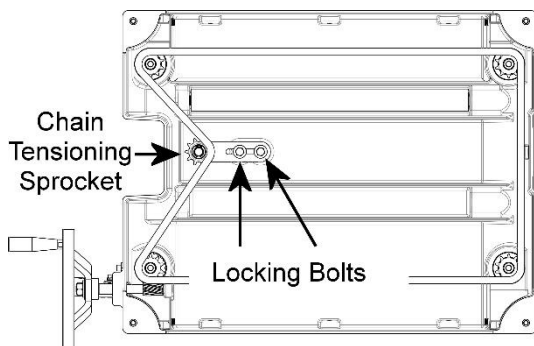

4. Push the chain tensioning sprocket against the chain with moderate tension to remove chain slack. Hold the sprocket in place, and re-tighten the locking bolts.
5. Clean and lubricate the chain as needed.
6. Re-install motor access panel after adjustments.

Adjust Table Roller Height

Your planer is equipped with one table roller to reduce feed resistance. There is no fixed rule for setting the exact height of the table rollers because each piece of wood behaves differently. The acceptable range of table roller height is **0.002" - 0.005"** above the table.

As a general rule of thumb:

- Raise the roller when planing rough stock.
- Lower the roller when planing smooth stock.

NOTICE: If the roller is set too high, the workpiece will be more likely to have snipe on the ends.

To adjust the table roller height:

1. **Disconnect the planer from the power source!!**

2. Each end of the table roller is equipped with a set screw and an eccentric adjuster. Make sure height adjustment is done on both ends.

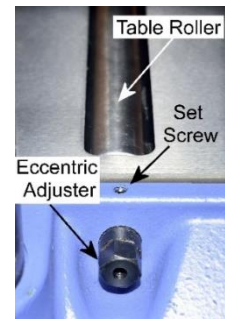

3. Loosen the set screws that hold the eccentric adjusters.
4. Rotate the eccentric adjusters to change the roller's height.
5. Use a dial indicator to verify the height is the same side-to-side. Make fine adjustments as needed.



6. Retighten the set screws to lock the eccentric adjusters after adjustments.

Adjust Cutterhead/Feed Roller Height Offset

The infeed/outfeed rollers pull the workpiece through the planer. To ensure optimal feeding/cutting performance, it is important to ensure the height offsets between the cutterhead and the feed rollers are correct.

The following diagram shows the height offset between the cutterhead and various components inside the headstock of the planer. The feed rollers and chip breaker are installed **BELOW** the lowest point of the cutterhead.

Chip Breaker

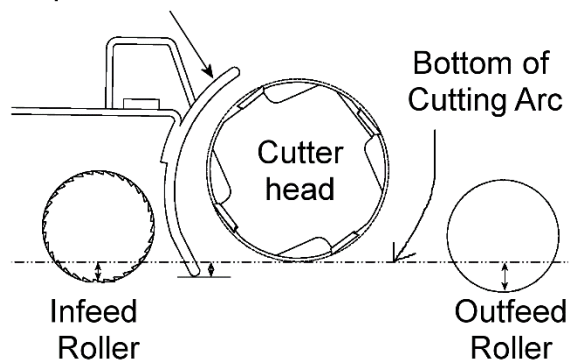

**Diagram not drawn to scale*

The height of the rollers and the chip breaker has been pre-calibrated in the factory and should not need further adjustments.

In case if adjustments are needed, you will need a dial indicator with a sturdy stand. If a dial indicator is not available, it is possible to make the adjustments with a homemade gauge block and a set of feeler gauges.

Clean the table and the rollers to remove any accumulations before making adjustments.



Method 1: Using a Dial Indicator

1. **Remove all tools from the planer.**
2. Turn on the planer, wait until it reaches full speed, then shift the feed rate control knob to 0 FPM (Neutral) position. This allows the feed rollers to rotate freely.

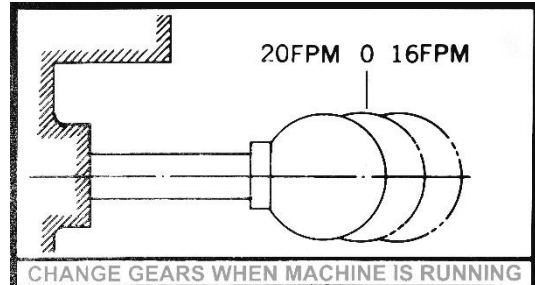

3. **Turn off the planer. Disconnect the planer from the power source!!**
4. Remove the belt cover so you can rotate the cutterhead with the drive belt.
5. Adjust the table height so that the dial indicator can fit right below the cutterhead. Rotate the cutterhead and use the dial indicator to locate its lowest point. Using a flat bottom tip for the dial indicator can make this task easier.



6. Zero the dial indicator. Use this as the reference point for measuring the offset between the cutterhead and the feed rollers.

7. Move the dial indicator to the lowest point of the feed rollers. The reading from the dial indicator now shows the offset between the cutterhead and the roller. Make adjustments if the offset goes beyond the tolerance listed below.



Tolerance

<i>Infeed Roller</i>	0.020" - 0.027" below
<i>Chip breaker</i>	0.000" - 0.020" below
<i>Outfeed Roller</i>	0.024" - 0.031" below

8. To adjust the height of the feed rollers, loosen the jam nuts on both ends of the feed roller. Rotate the set screws to change the height of the roller. Continue to calibrate until the cutterhead-roller offset is uniform across the entire feed roller.

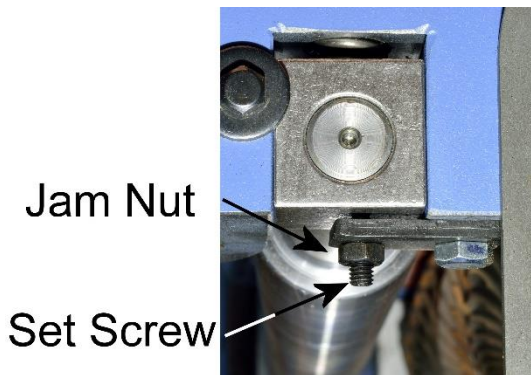

9. When the correct height is set, hold the set screws in place and re-tighten the jam nuts.
10. Re-install belt cover after adjustments.

Method 2: Using Feeler Gauge

1. Using hardwood, build a gauge block similar to the one below. The exact dimension is not critical. Just make sure the bottom clears the table roller. The top should be chamfered for better tool access and visibility.

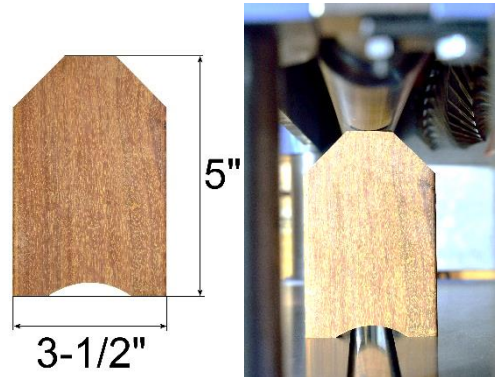

2. Remove all tools from the planer.
3. Turn on the planer, wait until it reaches full speed, then shift the feed rate control knob to 0 FPM (Neutral) position. This allows the feed rollers to rotate freely.

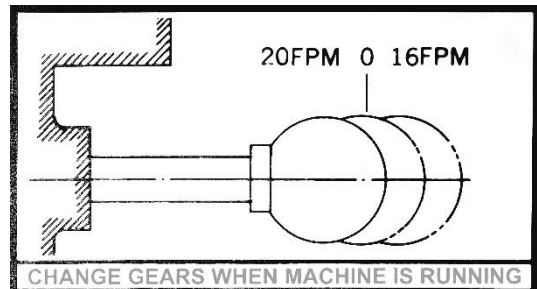

4. Turn off the planer. Disconnect the planer from the power source!!
5. Remove the belt cover so you can rotate the cutterhead with the drive belt.

- Raise the headstock, place the gauge block below the cutterhead. For checking the infeed roller's offset, put the **0.020"** feeler gauge on top of the gauge block.
- Lower the cutterhead until the lowest point of the cutterhead barely touches the feeler gauge.



- Remove the feeler gauge and move the gauge block under the infeed roller. The gauge block should fit right under the infeed roller if the height setting is perfect. You may need to rotate the infeed roller to find the lowest spot. Made adjustments according to the specifications as needed:



	Tolerance
<i>Infeed Roller</i>	0.020" - 0.027" below
<i>Chip breaker</i>	0.000" - 0.020" below
<i>Outfeed Roller</i>	0.024" - 0.031" below

- To adjust the height of the feed rollers, loosen the jam nuts on both ends of the feed

roller. Rotate the set screws to change the height of the roller. Continue to calibrate until the cutterhead-roller offset is uniform across the entire feed roller.

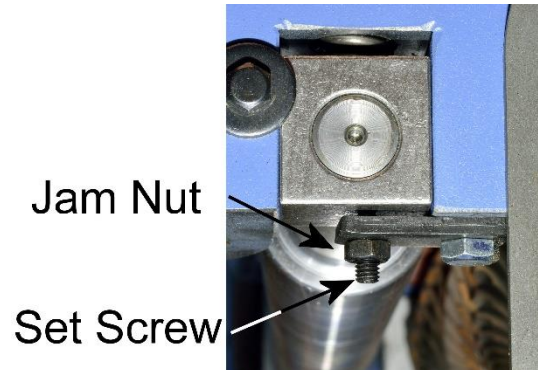

- When the correct height is set, hold the set screws in place and re-tighten the jam nuts.
- Repeat **STEP 7-13** for the outfeed roller, and use a 0.030" feeler gauge instead.
- Re-install belt cover after adjustments.

Adjust Feed Roller Tension

If your workpiece is slipping and not feeding through the machine, increase the feed roller pressure by turning the pressure bolts clockwise with a hex wrench.

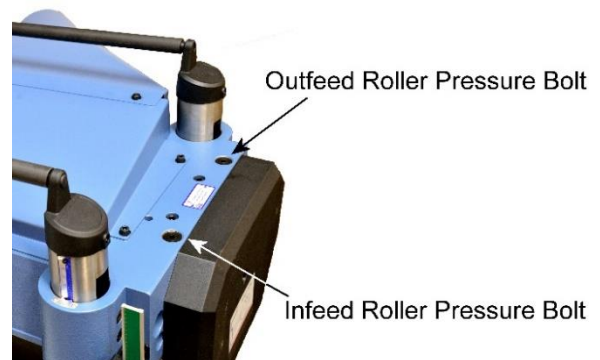

There is a pressure adjustment bolt on each end of the feed rollers. Make sure the adjustments are made on **BOTH** ends of the feed roller, so even pressure is applied across the entire feed roller.

If the workpiece is damaged by the feed roller, reduce pressure.

Adjust Cutterhead Height Scale

The cutterhead height scale is pre-calibrated at the factory. It can be adjusted to accommodate a different viewing angle, or if the scale is shifted.

1. Prepare a piece of 2x4 with a flat bottom for calibration.
2. Using the digital readout, plane the board down to 1-1/4" or 1". Use a caliper to measure the mid-section of the board for thickness.
3. Loosen the top and bottom screws that hold the scale in place.

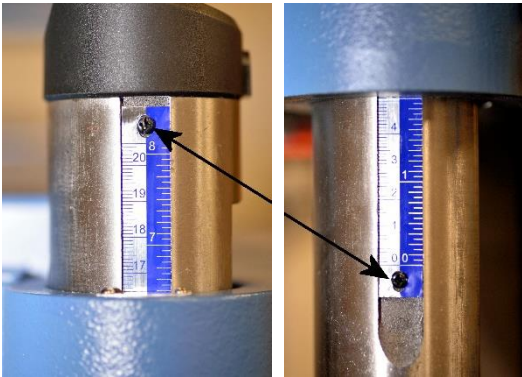

4. Shift the scale so that the pointer is pointing at the exact value as the thickness of the board.
5. Re-tighten the screws after adjustments.

Anti-Kickback Fingers Inspection

This planer is equipped with anti-kickback fingers. Once engaged, the workpiece can only move towards the cutterhead. This prevents accidental kickbacks which can cause serious injuries.

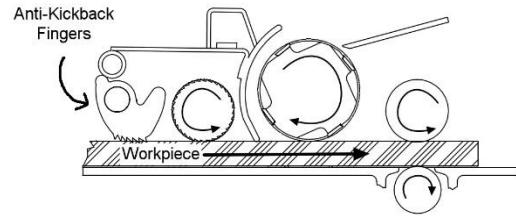

Inspect the anti-kickback fingers regularly to ensure they can move freely, and that their teeth are clean and are sharp enough to stop a board from moving backward. Clean and lubricate with a very light coat of SAE-30 machine oil as needed.

Replace anti-kickback fingers if they are damaged or worn.

⚠ CAUTION: Do not operate this planer without functioning anti-kickback fingers. Failure to comply can result in serious personal injuries.

Troubleshooting

Problem	Possible Cause	Possible Solution
Machine does not start.	Stop button is not reset.	Turn the rim of the STOP button clockwise to reset. The stop button will pop up.
	Machine is not connected to a power source.	<ol style="list-style-type: none"> 1. Make sure the machine is plugged in, or the power disconnect is at the ON position. 2. Check the electrical panel for a tripped circuit breaker or a blown fuse. 3. Ensure all electrical connections have good contacts.
	Low voltage / current.	Have an electrician to check/repair the circuit.
	Faulty switch/motor/capacitor.	Contact customer service for further assistance.
Machine trips the thermal protection or the circuit breaker, or blow fuses.	Machine is undersized for the operation.	Reduce the depth of cut and/or feed rate.
	Workpiece moisture level is too high.	Only plane wood with a moisture level below 20%.
	Machine is jammed.	Inspect the cutterhead and make sure it is not obstructed by woodchips. Check dust port and headstock and clear blockages.
	Too much load on a circuit.	Make sure the power circuit is sized for this machine. If the same circuit is shared, ensure the circuit is sized to supply power for all items in the circuit.
	Motor/capacitor issue.	Contact customer service for further assistance.
Machine stalls during operation.	Machine is undersized for the operation.	Reduce the depth of cut. Lower feed rate.
	Dull cutters	Rotate/replace cutter inserts.
	Belt slipping	Clean belt and the pulleys. Adjust belt tension.
	Motor/capacitor issue.	Contact customer service for further assistance.
Machine stopped during an operation.	Thermal overload protection triggered.	Hit the STOP button to reset overload protection. Wait for the machine to cool down. Reduce the depth of cut and feed rate.
Drive chain jumps during operation.	Loose chain.	Adjust chain tensioner.
	Misaligned sprockets.	Align sprockets.
	Worn sprockets.	Replace sprockets and chains.
Digital readout not functional.	Dead battery.	Replace battery.

Problem	Possible Cause	Possible Solution
Unable to move the feed rate knob.	Machine is not running.	Only move the feed rate knob while the machine is running idle at full speed.
Feed rollers do not move when the machine is running.	Gearbox is in neutral.	Shift feed rate control knob to set feed rate to 16/20 FPM while the machine is running idle at full speed.
Workpiece does not feed smoothly.	Low feed roller pressure.	Adjust feed roller spring tension.
	Incorrect feed roller height setting.	Adjust feed rollers height so the bottom of the rollers is below the lowest point of the cutterhead. Infeed Roller: 0.020" - 0.027" below. Outfeed Roller: 0.024" - 0.031" below.
	Dirty planer table/rollers.	Clean table and rollers. Apply paste wax on the table to reduce drag. Do not use silicone lubrication on the tabletop.
	Belt slipping	Clean belt and the pulleys. Adjust belt tension.
	Stuck planer bed roller.	Clean and lubricate roller.
Machine vibrates excessively or makes unexpected noise.	Damaged cutter inserts.	Replace cutter inserts.
	Machine stands on an uneven floor.	Reposition on a flat, level surface.
	Chip deflector is hitting the cutterhead.	Move chip deflector 1/16" - 1/8" away from cutterhead.
	V-belt worn, slipping or hitting belt cover.	Clean belt and pulleys. Adjust belt tension. Replace V-belt if it shows signs of aging.
	Feed roller bushing needs lubrication.	Lubricate bushings.
	Bent pulley	Replace pulley.
	Improper motor mounting.	Check and adjust motor mounting.
	Loose components.	Tighten fasteners of the component.
Worn bearings	Contact customer service for assistance.	
Uneven depth of cut side to side.	Cutterhead is not parallel with the planer table.	Adjust cutterhead-table parallelism. Tolerance: Less than 0.005" side-to-side.
Board thickness does not match the scale's measurement.	Cutterhead height scale is mispositioned.	Adjust the scale.

Problem	Possible Cause	Possible Solution
Workpiece came out twisted.	Workpiece is twisted before the cut.	Planer is not the tool to flatten a twisted workpiece. Flatten one side with a jointer before proceeding with a planer.
	Feed/bed roller is not parallel with the cutterhead.	Adjust roller/table parallelism.
Excessive snipe	Extension tables slope down.	Adjust the extension tables to make them parallel with the planer bed.
	Long workpiece is not supported properly.	Use auxiliary rollers to support a long workpiece.
	A small amount of sniping can happen sometimes.	Add an extra 6" length on a workpiece for planing, and then trim off the ends.
End of workpiece chipping	Aggressive depth of cut for the wood type.	Reduce the depth of cut.
	Planing end grain.	Do not plane end grain. Use a drum sander instead.
Chipping in workpiece surface.	Damaged cutter.	Rotate/replace cutter insert.
	Planing against/across grain; or knots.	Avoid planing workpieces with knots. Plane along the grain and perform downhill cut whenever possible. Moisten problematic areas before planing.
	Too much material was removed in one pass.	Reduce feed rate/depth of cut.
Indentation in workpiece surface.	Dirty rollers.	Remove all buildups on infeed, outfeed, and table rollers.
	Inefficient chip removal.	Check the dust collection system for suction. Adjust chip breaker and chip deflector.
Fuzzy looking finish.	Wood moisture content is too high.	Only process wood with less than 20% moisture content.
	Dull cutter.	Rotate/replace cutter insert.
	Some wood types tend to have fuzzy grain.	Adjust feed rate/depth of cut. Use sharp cutters.
Glossy looking finish.	Dull cutter.	Rotate/replace cutter insert.
	Cutting depth is too shallow.	Increase depth of cut.
Long line or ridges running along the length of the board.	Chipped cutter.	Rotate/replace cutter insert.
Serrated marks on the workpiece.	Cutting depth is too shallow.	Increase depth of cut.

Wiring Diagram

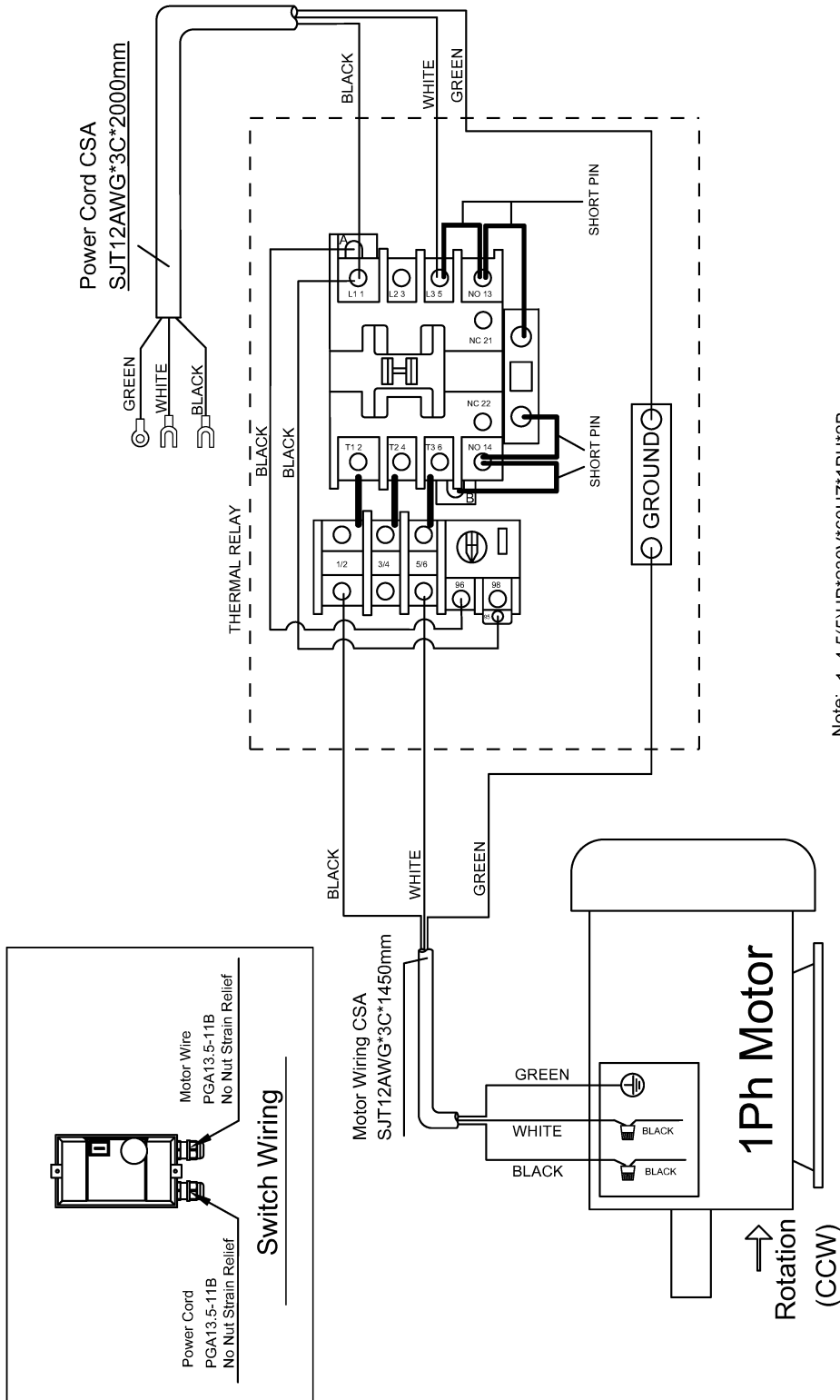

- Note:
1. 4.5(5)HP*230V*60HZ*1PH*2P
 2. Toothed Washer for (GROUND)
 3. Rated Amp for Overload Setting: 5 Amp
 4. Sherdian Switch

Cabinet Assembly

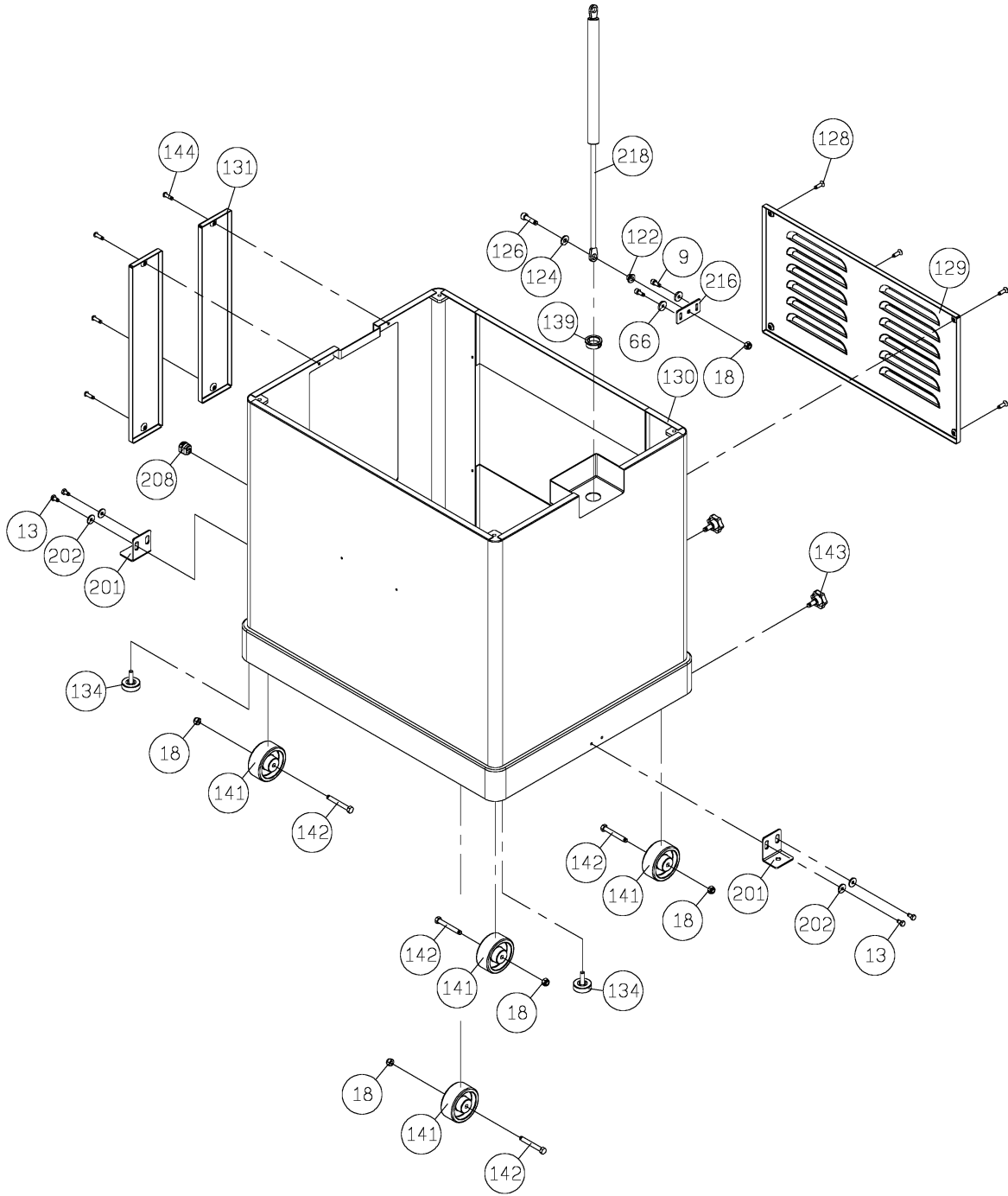

Headstock Assembly

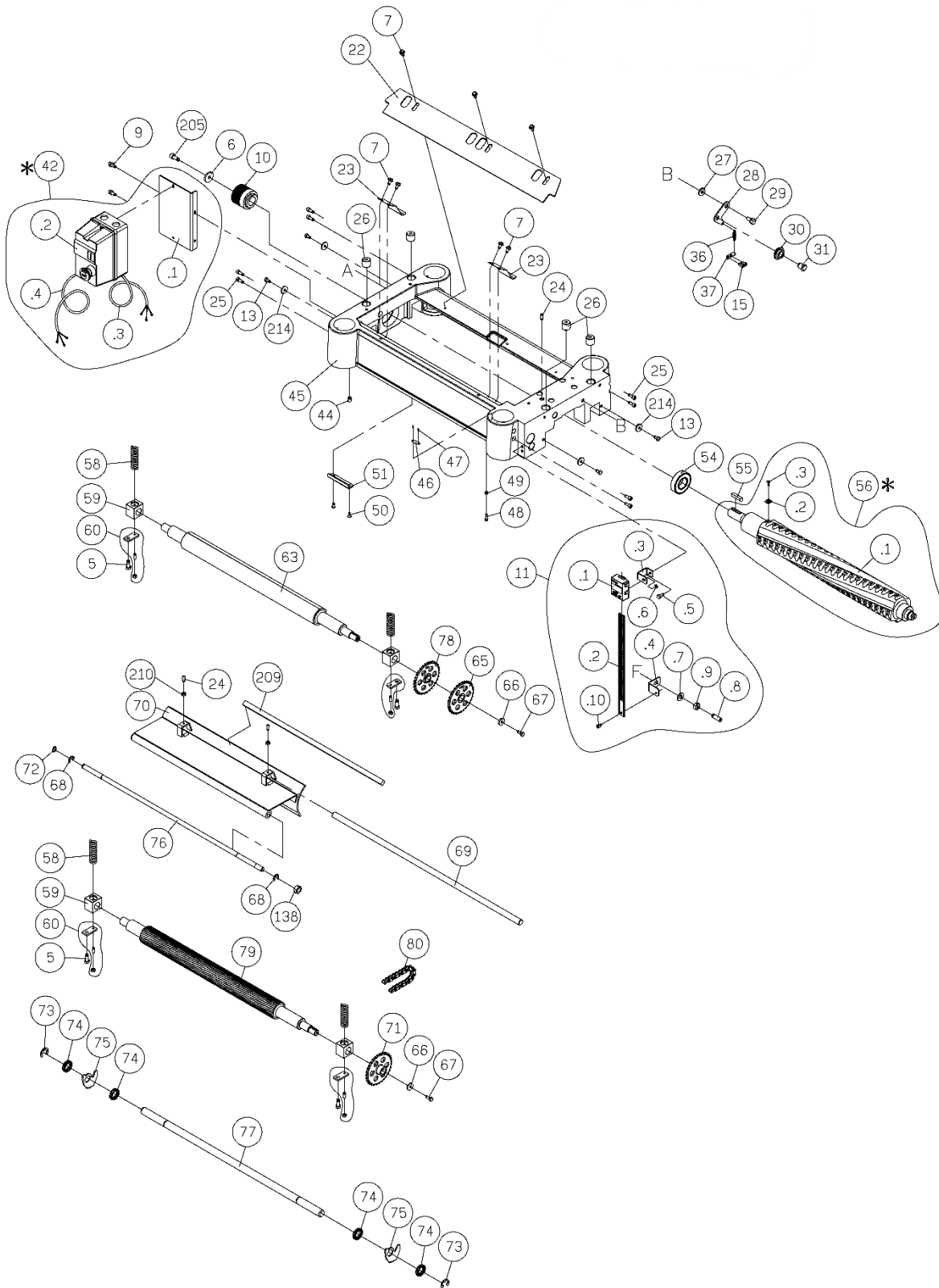

Gearbox Assembly

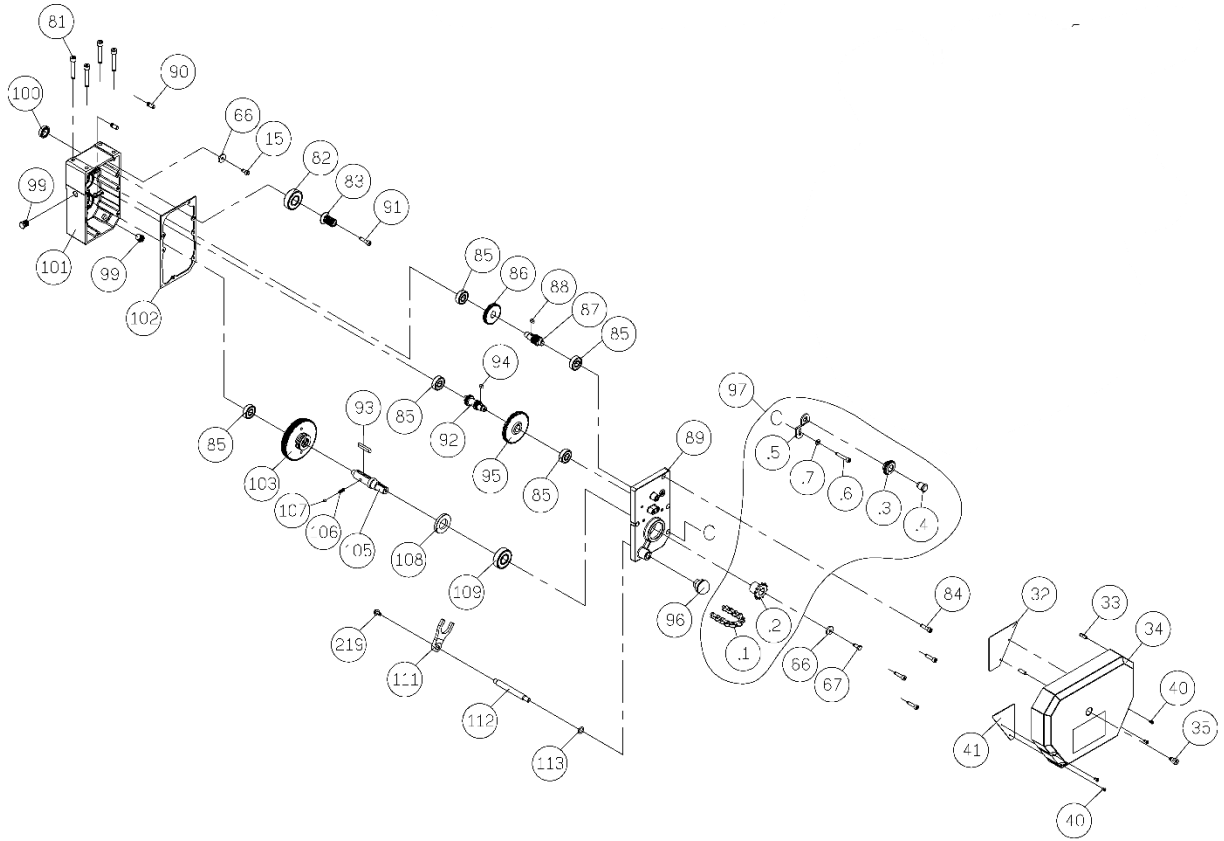

Cover and Dust Hood Assembly

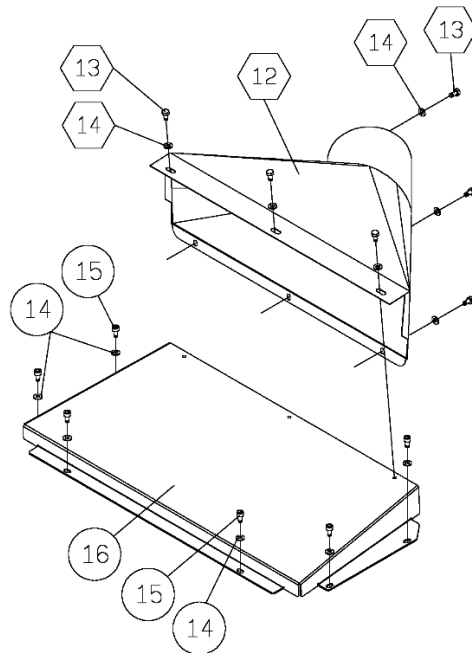

Key	Part Number	Descriptions	Specifications	QTY
1	230118-000	Knob		2
2	174572-000	BELT GUARD		1
3	014363-000	POLY-V-BELT	450J-12	1
4	380147-901	SPECIAL BOLT		2
5	000003-104	HEX. SCREW	M8*1.25P*20	4
6	006001-043	FLAT WASHER	8*30*4.0t	1
7	000902-102	HEX. SCREW W/WASHER	M6*1.0P*12	7
8	174573-902	MOTOR BRACKET		1
9	001802-101	CAP SCREW W/SPRING WASHER	M6*1.0P*16/6.5*10.5	12
10	381423-902	CUTTER HEAD PULLEY		1
11	924753-000	DRO SOLD AS ASSEMBLY ONLY		1
.1	491142-000	DIGITAL READ OUT (Reference only)		1
.2	950792-000	SENSOR STRIP ASSEMBLY (Reference only)		1
.3	174757-904	BRACKET-UPPER (Reference only)		1
.4	174758-904	BRACKET-DOWN (Reference only)		1
.5	000002-102	HEX. SCREW (Reference only)	M6*1.0P*15	1
.6	006002-009	FLAT WASHER (Reference only)	5.2*10*1.0t	1
.7	006001-075	FLAT WASHER (Reference only)	10.3*22*2.0t	1
.8	000205-102	SET SCREW (Reference only)	M10*1.5P*30	1
.9	008007-100	HEX. NUT (Reference only)	M10*1.5P(17B*8H)	1
.10	000102-102	SOCKET HEAD CAP SCREW (Reference only)	M5*0.8P*8	1
12	170488-000	DUST CHUTE		1
13	000002-101	HEX. SCREW	M6*1.0P*12	14
14	006001-032	FLAT WASHER	6.6*13*1.0t	12
15	000103-103	SOCKET HEAD CAP SCREW	M6*1.0P*12	9
16	174574-000	DUST HOOD		1
17	000204-109	SET SCREW	M8*1.25P*40	1
18	008306-100	HEX. LOCK NUT	M8*1.25P(13B*9H)	8
19	240017-000	HAND WHEEL		1
20	230114-906	HANDLE		1
21	006001-040	FLAT WASHER	8*30*3.0t	1
22	250172-617	CHIP DEFLECTOR		1
23	270015-901	SPRING PLATE		2
24	000203-106	SET SCREW	M6*1.0P*16	3
25	000104-104	SOCKET HEAD CAP SCREW	M8*1.25P*16	8
26	380200-901	TENSION BOLT		4

Key	Part Number	Descriptions	Specifications	QTY
27	006001-041	FLAT WASHER	8.2*22*3.0t	13
28	170405-901	BRACKET		1
29	290039-901	SHAFT		1
30	130071-000	CHAIN TENSIONER		1
31	360349-901	CHAIN TENSIONER SHAFT		1
32	174671-902	SIDE COVER GUARD		1
33	011004-102	SPRING PIN	6*20	2
34	251337-615	SIDE COVER		1
35	000104-103	SOCKET HEAD CAP SCREW	M8*1.25P*12	1
36	280050-000	SPRING		1
37	170406-901	HOOK		1
38	574905-000	SCALE		1
39	000301-101	ROUND HEAD SCREW	M3*0.5P*6	2
40	002001-704	SOCKET HEAD CAP SCREW	M4*0.7P*8	4
41	174659-902	SIDE COVER GUARD		1
42	937953-000	MAGNETIC SWITCH ASSEMBLY	5HP*220V-240V*1PH	1
.1	171404-904	SWITCH PLATE		1
.2	821016-002	MAGNETIC SWITCH	5HP*220V-240V*1PH	1
.3	473004-006	CONNECT WIRE MOTOR	SJT12AWG*3C*1450mm	1
.4	473004-012	CONNECT WIRE POWER	SJT12AWG*3C*2000mm	1
43	000205-101	SET SCREW	M10*1.5P*12	7
44	000204-103	SET SCREW	M8*1.25P*12	1
45	051418-000	HEAD CASTING		1
46	170464-156	POINTOR		1
47	002301-201	RIVET	2*5	2
48	000001-102	HEX. SCREW	M5*0.8P*16	1
49	008004-100	HEX. NUT	M5*0.8P(8B*4H)	1
50	000402-104	FLAT HEAD SCREW	M5*0.8P*12	2
51	170409-901	LIMIT PLATE		1
54	030210-002	BALL BEARING	6206	1
55	012204-001	KEY	8*8*36	1
56	924685-000	HELICAL CUTTERHEAD ASSEMBLY	4 SLOTS	1
.1	220197-000	HELICAL CUTTERHEAD ONLY		1
.2	P-15mm 4S	INSERT (SOLD IN BOX OF 10)		68
.3	038201-101	TORX SCREW	#10-32UNF*1/2"	68
57	000003-105	HEX. SCREW	M8*1.25P*25	8

Key	Part Number	Descriptions	Specifications	QTY
58	280051-000	SPRING		4
59	130039-000	BUSHING		4
60	923901-000	RETAINER PLATE ASSEMBLY		4
63	360407-000	OUTFEED ROLLER		1
65	150025-000	CHAIN SPROCKET		1
66	006001-020	FLAT WASHER	6.2*20*3.0t	8
67	000002-103	HEX. SCREW	M6*1.0P*16	3
68	010207-000	RETAINING RING	ETW-10	2
69	360386-000	SHAFT		1
70	170478-019	CHIP BREAKER		1
71	150028-000	CHAIN SPROCKET		1
72	010003-000	RETAINING RING	STW-12	1
73	010209-000	RETAINING RING	ETW-15	2
74	250160-615	SPACER		56
75	172281-905	ANTI-KICK BACK		55
76	361325-902	SHAFT		1
77	360388-000	SHAFT		1
78	150027-000	CHAIN SPROCKET		1
79	360389-000	INFEED ROLLER		1
80	016308-002	CHAIN	#06B*67P	1
81	000104-114	SOCKET HEAD CAP SCREW	M8*1.25P*50	4
82	030208-002	BALL BEARING	6204	1
83	320196-000	GEAR		1
84	000103-108	SOCKET HEAD CAP SCREW	M6*1.0P*25	4
85	030106-002	BALL BEARING	6201	5
86	320197-000	GEAR		1
87	320160-000	SHAFT		1
88	012003-003	KEY	5*5*12	2
89	090350-920	GEARBOX COVER		1
90	360355-901	PIN		2
91	002602-106	CAP LOCKING SCREW	M6*1.0P*25	1
92	320205-000	SHAFT		1
93	012004-003	KEY	6*6*40	1
94	012003-002	KEY	5*5*10	1
95	320198-000	GEAR		1

Key	Part Number	Descriptions	Specifications	QTY
96	250372-615	KNOB		1
97	920744-000	SPROCKET & CHAIN ASSEMBLY	FEED RATE 16/20FPM	1
.1	016304-000	CHAIN	#06B*50P	1
.2	150008-000	CHAIN SPROCKET		1
.3	130071-000	CHAIN TENSIONER		1
.4	360349-901	CHAIN TENSIONER SHAFT		1
.5	170474-901	BRACKET		1
.6	000103-110	SOCKET HEAD CAP SCREW	M6*1.0P*35	1
.7	006001-032	FLAT WASHER	6.6*13*1.0t	1
99	043401-000	PLUG	PT1/4"-19	2
100	043608-000	OIL SEAL	TC28*40*8	1
101	090349-920	GEARBOX		1
102	340012-615	GEARBOX GASKET		1
103	922351-000	GEAR ASSEMBLY		1
105	360357-000	SHAFT		1
106	280052-000	SPRING		1
107	017002-000	STEEL BALL	6mm	1
108	043505-000	OIL SEAL	SC25*47*6	1
109	030109-002	BALL BEARING	6204	1
111	070014-000	SHIFTING FORK		1
112	360358-901	SHAFT		1
113	043303-000	RETAINING RING	P12	1
115	050301-000	EXTENSION WING		2
117	000204-105	SET SCREW	M8*1.25P*20	6
118	001803-102	CAP SCREW W/SPRING WASHER	M8*1.25P*20/8.2*13.7	4
119	174575-000	PLATE		1
120	000104-111	SOCKET HEAD CAP SCREW	M8*1.25P*35	1
121	360391-000	ECCENTRIC SHAFT		2
122	361323-902	BUSHING		3
123	660330-000	GAS CYLINDER	750N Motor	1
124	006001-054	FLAT WASHER	8.5*20*2.0t	3
125	000203-104	SET SCREW	M6*1.0P*12	2
126	000104-110	SOCKET HEAD CAP SCREW	M8*1.25P*30	2
127	921208-000	ROLLER W/BEARING		1
.1	190007-000	ROLLER		1
.2	030007-001	BALL BEARING	6201	2

Key	Part Number	Descriptions	Specifications	QTY
128	000403-104	FLAT HEAD SCREW	M6*1.0P*20	4
129	170479-000	STAND ACCESS PANEL		1
130	174576-000	STAND		1
131	174577-000	COVER		2
132	000003-107	HEX. SCREW	M8*1.25P*35	4
134	230049-000	FOOT		2
136	006001-091	FLAT WASHER	13*28*3.0t	1
137	901167-000	MOTOR W/PULLEY ASSEMBLY	5HP*230V*60HZ*1PH	1
.1	603162-000	MOTOR	5HP*220-240V*60HZ*1PH	1
.1.01	496076-000	START CAPACITOR	600MFD/125VAC (45*85)	1
.1.02	496077-000	RUNNING CAPACITOR	50UF/350VAC (45*85)	1
.2	573556-000	MOTOR TAG	5HP*230V*60HZ*1PH	1
.3	012206-002	KEY		1
.4	002601-107	CAP LOCKING SCREW	M8*1.25P*25	1
.5	381424-902	MOTOR W/PULLEY ASSEMBLY		1
.6	006001-043	FLAT WASHER	8.2*30*4.0t	1
138	008009-100	HEX. NUT	M12*1.75P(19B*10H)	2
139	021802-000	RELIEF BUSHING	NB-2430	1
141	250399-615	WHEEL		4
142	000003-316	HEX. SCREW	M8*1.25P*60	4
143	004001-101	KNOB	5/16"-18NC*3/4"	2
144	000801-104	ROUND HEAD HEX SCREW	M6*1.0P*20	4
146	130040-000	NUT		4
147	361321-000	ELEVATING SCREW		4
148	051419-000	COLUMN		3
149	051420-000	BASE CASTING		1
150	016004-000	CHAIN	#40*166P	1
151	170413-901	CHAIN TENSIONER BRACKET		1
152	360362-901	SPROCKET SHAFT		1
153	150011-000	CHAIN SPROCKET		1
154	010006-000	RETAINING RING	STW-15	1
156	030003-001	BALL BEARING	6202	4
157	010103-000	RETAINING RING	RTW-35	4
158	150012-000	CHAIN SPROCKET		4
159	006001-078	FLAT WASHER	10.5*19*1.5t	4
160	008008-100	HEX. NUT	M10*1.25P(17B*8H)	4
161	320404-000	SCREW		1
162	160094-903	SPACER		1

Key	Part Number	Descriptions	Specifications	QTY
163	030007-001	BALL BEARING	6201	1
164	051421-000	MAIN COLUMN		1
165	160093-903	SPACER		3
167	160095-903	SPACER		4
168	006001-153	FLAT WASHER	13.5*30*3t	4
169	000106-101	SOCKET HEAD CAP SCREW	M12*1.75P*60	4
170	012002-004	KEY	4*4*10	1
190	251318-615	ROLLER BRACKET		4
191	361322-902	ROLLER		2
192	000302-103	ROUND HEAD SCREW	M4*0.7P*10	4
194	320204-000	LEAD SCREW		1
196	010102-000	RETAINING RING	RTW-32	1
197	190008-901	SPACER		1
201	174711-000	SHIPPING PLATE		2
202	006001-036	FLAT WASHER	6.7*19*2.0t	4
205	002601-107	CAP LOCKING SCREW	M8*1.25P*25	1
208	020005-000	STRAIN RELIEF	SB8R-3	1
209	200057-646	FOAM GASKET	3/8"*1/2"*525L	1
210	008304-100	HEX. LOCK NUT	M6*1.0P(10B*7H)	2
214	006001-021	FLAT WASHER	6.2*22*3t	4
216	174769-000	ADJUSTMENT PLATE		2
218	660288-000	GAS CYLINDER	450N	1
219	029502-201	HEX. SCREW W/LOCK WASHER	M6*1.0P*12	1
220	006007-140	FLAT WASHER	10.5*32*1.0t	2

Spare Parts

Part Number	Descriptions	Specifications	QTY
P-15mm 4S	INSERT (SOLD IN BOX OF 10)		10
038201-101	TORX SCREW	#10-32UNF*1/2"	10

Tools for Assembly

Part Number	Descriptions	Specifications	QTY
040004-000	HEX WRENCH (Local Purchase)	4MM FOR EXTENSION WING SCREWS	1
174569-904	COMBO WRENCH (Local Purchase)	10*13 FOR EXTENSION WING HEX. SCREWS & DUST CHUTE	1
040204-000	COMBO WRENCH (Local Purchase)	12*14 FOR HANDLE	1
040206-000	COMBO WRENCH (Local Purchase)	17*19 FOR HANDLE WHEEL	1

Warranty and Service

Oliver Machinery makes every effort to assure that its equipment meets the highest possible standards of quality and durability. All products sold by Oliver Machinery are warranted to the original customer to be free from defects for a period of two (2) years on all parts excluding electronics and motors which are warranted for one (1) year from the date of shipment. Oliver Machinery's obligation under this warranty shall be exclusively limited to repairing or replacing products or parts or components, at its sole option, determined by Oliver Machinery to be defective. Oliver Machinery shall not be required to provide other form of indemnity or compensation including but not limited to compensatory damages.

This warranty does not apply to defects due to direct or indirect misuse, abuse, negligence, accidents, unauthorized repairs, alternation outside our facilities, lack of maintenance, acts of nature, or items that would normally be consumed or require replacement due to normal wear and tear.

OTHER TERMS

To obtain and exercise the warranty right, please call 800-559-5065 or fill out warranty request form online at www.olivermachinery.net.

Warranty parts are shipped via Parcel or Ground. Additional charges will occur and charge to customers if express shipping is required.

DISCLAIMER

Under no circumstances shall Oliver Machinery be liable for death, personal or property injury, or damages arising from the use of its products.

Oliver Machinery reserves the right to make changes without prior notice to its products to improve function or performance or design.

FOR MORE INFORMATION

If you need assistance or have questions beyond what is covered in the scope of this warranty information, please call 800-559-5065 or email us at info@olivermachinery.net.



Oliver Machinery is always adding new Industrial Woodworking products to the line.

For complete, up-to-date product information, visit us online at:

WWW.OLIVERMACHINERY.NET

or call toll free 1-800-559-5065

**** SAVE THIS MANUAL FOR FUTURE REFERENCES. ****