

Sander

# Model 6910

Owner's Manual

For Models Manufactured Since 04/2006



Oliver Machinery  
1-800-559-5065  
921 Thomas Ave SW  
Renton, WA 98057

[info@olivermachinery.net](mailto:info@olivermachinery.net)



Stock Number: 6910.003  
Manual Version: 2.0.0





**READ AND UNDERSTAND ALL INSTRUCTIONS IN THIS MANUAL BEFORE ATTEMPTING TO ASSEMBLE OR OPERATE THE MACHINE.**

**FOLLOW THE INSTRUCTIONS AND THINK SAFETY!**

**THE OWNER OF THIS MACHINE IS SOLELY RESPONSIBLE FOR THE SAFETY OF ANYONE USING THIS MACHINE. SUCH RESPONSIBILITY INCLUDES BUT NOT LIMITED TO:**

- **PROPER ASSEMBLY, OPERATION, INSPECTION, MAINTENANCE, AND RELOCATION OF THE MACHINE.**
- **PROPER TRAINING FOR THE OPERATORS AND ENSURES THIS MANUAL IS AVAILABLE AT ALL TIMES.**
- **USAGE AUTHORIZATION.**
- **USAGE OF SAFETY AND PROTECTION DEVICES.**

**OLIVER MACHINERY DISCLAIMS ANY LIABILITY FOR MACHINES THAT HAVE BEEN ALTERED OR ABUSED. OLIVER MACHINERY RESERVES THE RIGHT TO EFFECT AT ANY TIME, WITHOUT PRIOR NOTICE, THOSE ALTERATIONS TO PARTS, FITTINGS, AND ACCESSORY EQUIPMENT WHICH THEY MAY DEEM NECESSARY FOR ANY REASON WHATSOEVER.**

**\*\* SAVE THIS MANUAL FOR FUTURE REFERENCES. \*\***

## **PROP 65 NOTICE**

**WARNING:** Drilling, sawing, sanding, or machining wood products can expose you to wood dust, and/or other chemicals that are known to the State of California to cause cancer, birth defects, or other reproductive harm.

Some examples of these chemicals are:

- Lead from lead-based paints.
- Crystalline silica from bricks, cement, and other masonry products.
- Arsenic and chromium from chemically treated lumber.

Avoid inhaling wood dust and other harmful chemicals. Use a dust mask and/or other safety devices for personal protection.

For more information go to <http://www.P65Warnings.ca.gov/wood>

## Table of Contents

<b>Introduction</b> .....	<b>5</b>	<b>Dust Collection</b> .....	<b>22</b>
<b>Specifications</b> .....	<b>6</b>	<b>Test Run</b> .....	<b>23</b>
<b>Identification</b> .....	<b>8</b>	<b>Operation</b> .....	<b>24</b>
<b>Safety</b> .....	<b>10</b>	<b>Preparation before Sanding</b> .....	<b>24</b>
<b>General Safety Guidelines</b> .....	<b>10</b>	Material Selection and Inspection .....	24
<b>Safety Guidelines Specific to Sander</b> .....	<b>11</b>	Supporting Large Workpiece.....	24
<b>Electricals</b> .....	<b>13</b>	Safety Devices .....	24
<b>Minimum Circuit Size Required for Model</b>		Clear the Work Area.....	24
<b>6910 Sander</b> .....	<b>13</b>	<b>Table Tilt Adjustment</b> .....	<b>25</b>
<b>Grounding</b> .....	<b>13</b>	<b>90° Sanding</b> .....	<b>26</b>
<b>Indoor Use Only</b> .....	<b>13</b>	<b>Bevel Sanding</b> .....	<b>26</b>
<b>Electrical Wiring</b> .....	<b>14</b>	<b>Accessories</b> .....	<b>27</b>
<b>Setup</b> .....	<b>15</b>	<b>Maintenance</b> .....	<b>28</b>
<b>Shop Preparation</b> .....	<b>15</b>	Cleaning Sanding Sleeves .....	29
<b>Receiving</b> .....	<b>16</b>	Changing Sanding Sleeves .....	29
<b>Inventory</b> .....	<b>17</b>	Table Positive Stops Adjustment.....	31
<b>Cleaning</b> .....	<b>18</b>	Lubrication .....	32
<b>Removing Machine from Crate</b> .....	<b>18</b>	<b>Troubleshooting</b> .....	<b>33</b>
<b>Assembly</b> .....	<b>19</b>	<b>Wiring Diagram</b> .....	<b>35</b>
Table Installation .....	19	<b>Parts List</b> .....	<b>36</b>
Sanding Sleeves Installation .....	19	<b>Maintenance Record</b> .....	<b>41</b>
Sanding Spindle Installation/Removal .....	20	<b>Notes</b> .....	<b>42</b>
Spindle and Table Insert Storage .....	22	<b>Warranty and Service</b> .....	<b>43</b>

---

# Introduction

Thank you for choosing Oliver! This manual contains important information on how to safely set up, operate, and maintain this machine. Please take the time to read through this manual, and make sure you understand all instructions.

While this manual may provide tips on optimizing the result of your workpiece, the manual is not intended as a substitute for formal woodworking training. If you need to know how to safely complete a woodworking task, please consult knowledgeable and qualified sources before proceeding further.

We made every effort to keep this manual up-to-date. Instructions, specifications, drawings, and photographs in this manual should match the machine delivered. If you find any differences or anything that seems confusing in this manual, please check our website for an updated version:

## WWW.OLIVERMACHINERY.NET/MANUALS

Alternatively, you can contact our technical support for help:

**1-800-559-5065**

Before calling, please note down the manufacture date and the serial number of the machine. You can find the information on a nameplate located on the back of the machine cabinet. This information is needed to provide proper technical support, and to determine if an updated manual is available for your machine.

Please let us know how well this manual serves you. If you have any suggestions, please call the number above or email us at:

**info@olivermachinery.net**

We love to hear from our customers and make improvements.

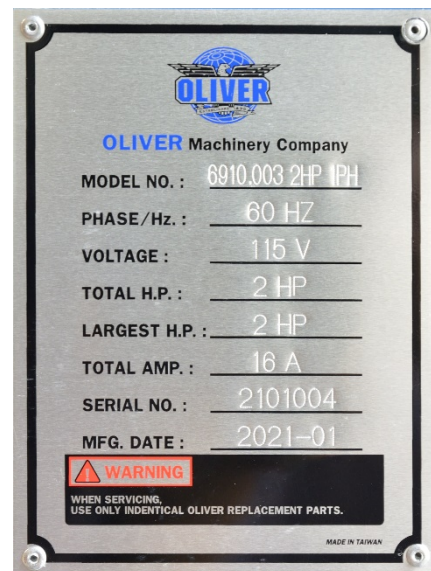

# Specifications

## Quick View

Model	6910 Sander
Stock Number	6910.003
Power Requirement	115V / 230V, 1Ph, 60Hz
Motor	TEFC 2HP, 115V / 230V, 1Ph
Spindles Included	10
Spindle Diameters	1/4" – 4"
Spindle Speed	1720 RPM
Oscillation Stroke Length	1-1/2"
Table Dimensions	27"(W) x 25"(D)
Table Tilt Angle	0° - 45°
Dimensions	27"(W) x 25"(D) x 39-1/4"(H)
Footprint	19-1/2"(W) x 18-1/2"(D)
Fully Assembled Weight	286 lbs.
Warranty	1 Year (Motor and electronics) 2 Years (All other parts)

## Product Dimensions

Width x Depth x Height (Fully Assembled)	27"(W) x 25"(D) x 39-1/4"(H)
Footprint	19-1/2" (W) x 18-1/2"(D)
Fully Assembled Weight	286 lbs.

## Shipment Info

Packaging	Cardboard Box with Pallet
Content	Sander with Included Accessories
Dimensions	27-3/4"(L) x 29-1/4"(W) x 45-1/2"(H)
Weight	319 lbs.
Approx. Assembly Time	30 Minutes
Must Ship Upright	YES
Stackable	NO

## Electricals

Power Requirement	115V / 230V, 1Ph, 60Hz
Prewired Voltage	115V
Full Load Current Rating	16A @ 115V 8A @ 230V
Recommended circuit size	20A @ 115V 15A @ 230V
Power Switch Type	Button Switch
Connection Type	NEMA 5-15 Plug with 58" 14AWG Cord (Prewired to 110V)

### *Motor*

Motor Type	TEFC
Horsepower	2HP
Power Requirement	115V/230V, 1Ph, 60Hz
Full Load Current Rating	16A @ 115V 8A @ 230V
Speed	1720 RPM
Power Transfer Mechanism	Direct Drive
Bearing type	Permanently Sealed Ball Bearing

### *Sanding Spindles*

Number of Spindles Included	10
Dimensions	1/4" -> 5-Inches 3/8", 1/2", 5/8" -> 6-Inches 3/4", 1", 1-1/2", 2", 3", 4" -> 9-Inches
Speed	1720 RPM
Oscillation Stroke Length	1-1/2"
Oscillations Per Minute	75

### *Table*

Material	Precision Ground Cast Iron
Dimensions	27"(W) x 25"(D)
Tilt Angle	0° - 45°
Number of Table Inserts	3

### *Safety*

Number of Dust Ports	1
Dust Port Size	4"
Minimum CFM Required	300 CFM
Sound Rating @ 2' distance	72 dB

### *Others*

Serial Number Location	On the left-hand side of the machine stand.
Certification	CSA 175381
Country of Origin	Taiwan

# Identification

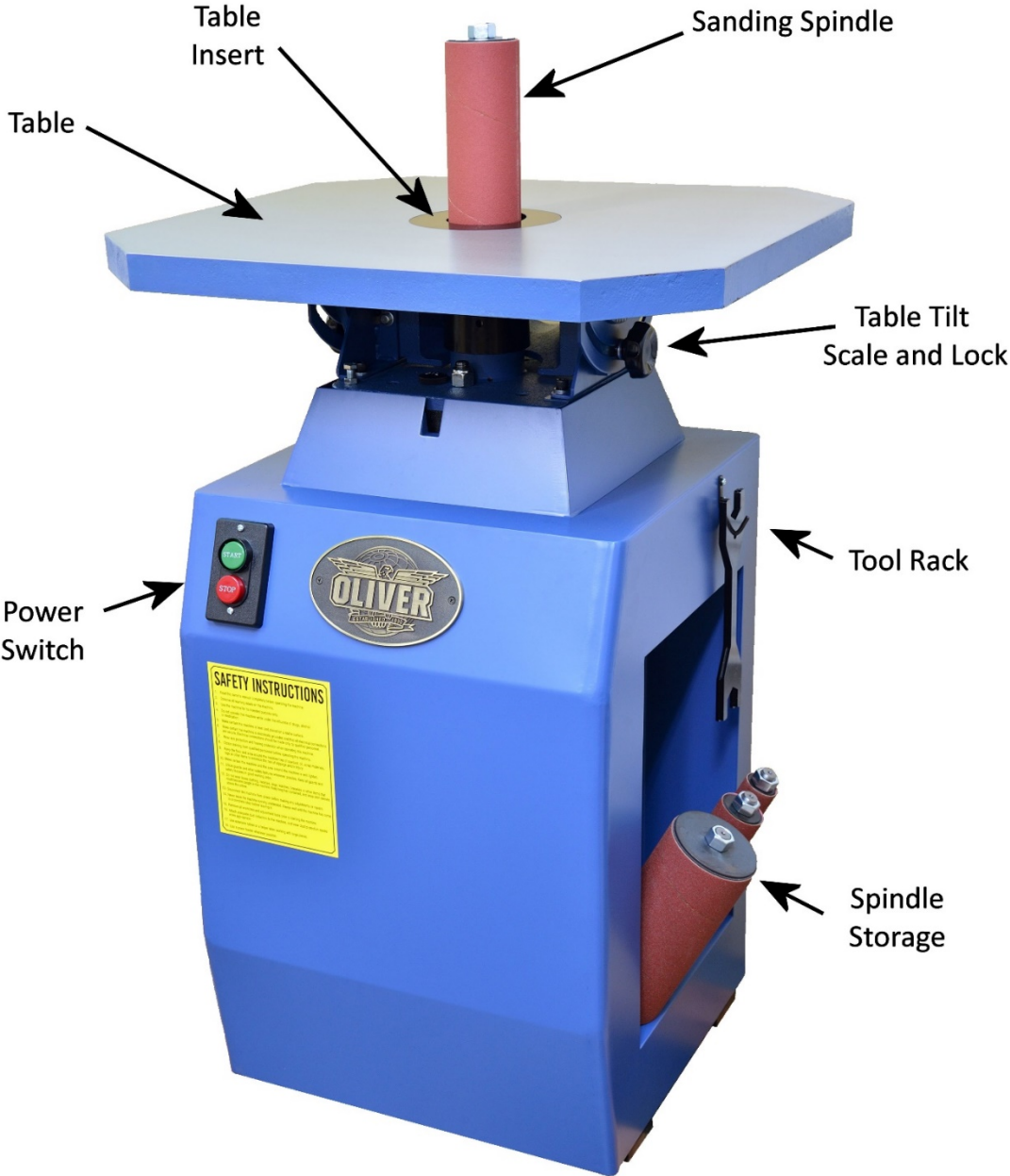



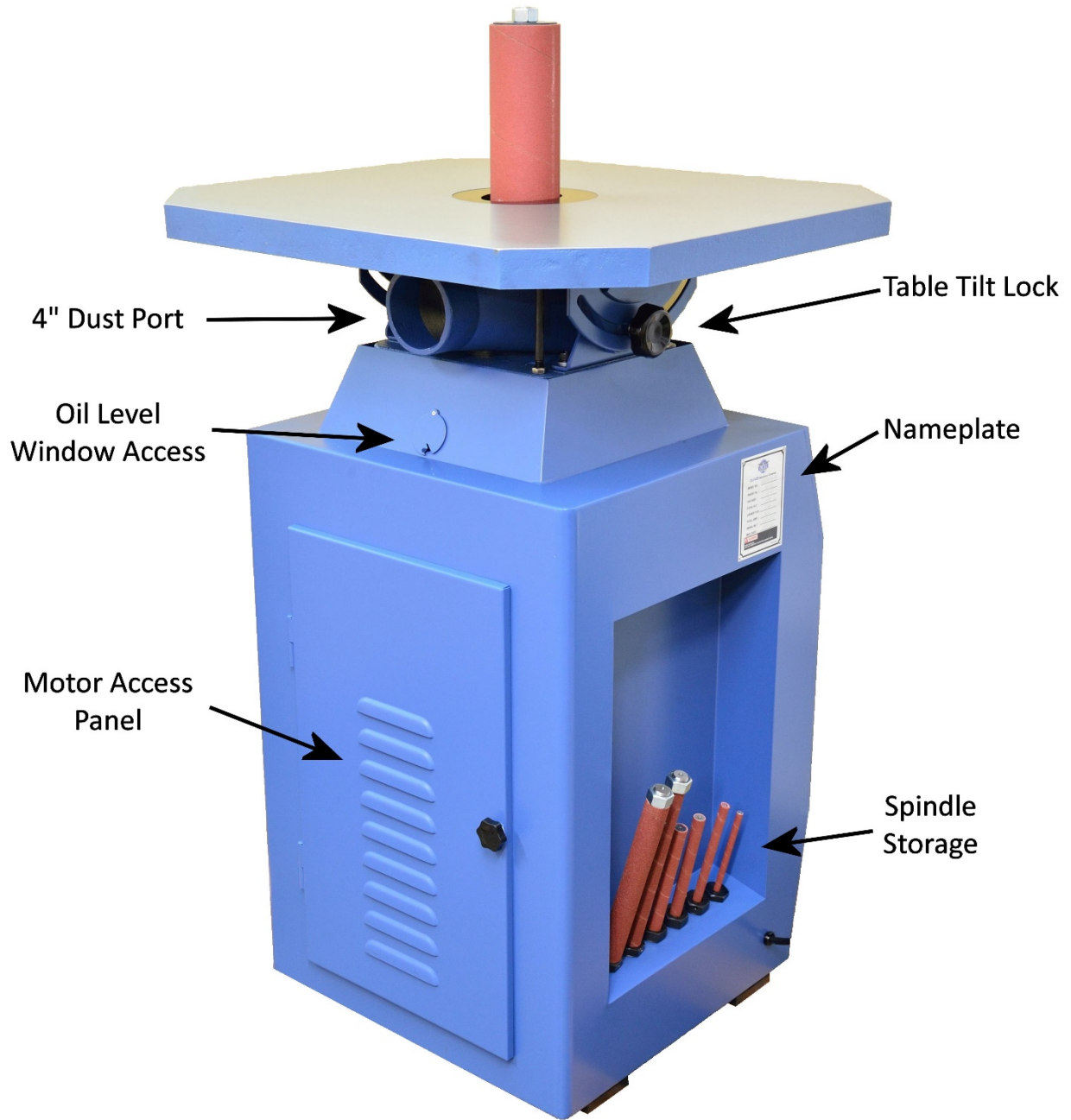



# Safety

Oliver Machinery has made every attempt to provide a safe, reliable, easy-to-use piece of machinery. Safety, however, is ultimately depending on the individual machine operator. **Before operating this machine, please become familiar with the following safety labels and guidelines.**

 <b>DANGER</b>	This indicates an imminently hazardous situation which, if not avoided, <b>WILL</b> cause death or serious injury.
 <b>WARNING</b>	This means if the warning is not taken seriously, it <b>CAN</b> cause death or serious injury.
 <b>CAUTION</b>	This means if the precaution is not taken, it <b>MAY</b> cause minor or moderate injury.
<b>IMPORTANT</b>	This is a tip for properly operating the machine to avoid machine damage.

## General Safety Guidelines

1. **FAMILIARIZE** yourself with all safety instructions found in this manual. Know the limitations and hazards associated with this machine. Do not operate or service this machine until you are properly trained.
2. **ELECTRICAL GROUNDING**, when done properly, reduce the risk of electrocution, shocks, and fire. Make certain that the machine frame is electrically grounded and that a ground lead is included in the incoming electrical service. In cases where a cord and a plug are used, make certain that the grounding plug connects to a suitable ground. Follow the grounding procedure indicated in the electrical code of your area.
3. **DISCONNECT** the machine from power before performing any service, maintenance, adjustments, or when changing cutters. A machine under repair should be RED TAGGED to show it should not be used until the maintenance is complete.
4. **EYE PROTECTION**: Always wear an approved safety face shield, goggles, or glasses that complies with ANSI Z87.1 and CSA Z94.3 standards. Common eyeglasses are not safety glasses, and may not provide adequate protection.
5. **EAR PROTECTION**: Use hearing protective devices where the noise exceeds the level of exposure allowed in Section 1910.95 of the OSHA Regulations. When in doubt, use it.
6. **GUARDS**: Keep machine guards in place for all applicable operations. If any guards are removed for maintenance, DO NOT OPERATE the machine until all guards are reinstalled. Check clearance between the guards and the cutter before starting the machine.
7. **WORKPLACE SAFETY**: Keep the floor around the machine clean. Scrap material, sawdust, oil, and other liquids increase the risk of tripping or slipping. Be sure to clean up the table before starting the machine. Make certain the work area is well lighted and that a dust collection system is available to minimize dust. Use anti-skid floor strips on the floor area where the operator normally stands and mark off the machine work area. Provide adequate workspace around the machine.

8. **ACCESS CONTROL** should be enforced so only trained personnel can access the work area and operate the machine. Use a childproof power switch when applicable.
9. **STAY ALERT** at all times. Do not operate this machine while under the influence of drugs/alcohol, or when not feeling well.
10. **NEVER STAND ON THE MACHINE.** This prevents injuries from tipping-related accidents and accidental contacts with cutters or abrasives.
11. **REPLACEMENT PARTS:** Use only genuine Oliver Machinery replacement parts and accessories recommended for this machine. Generic parts made by other manufacturers may create a safety hazard and WILL void the factory warranty and other guarantees.
12. **PROPER USE:** Do not use this machine for anything other than its intended use. If used for other purposes, Oliver Machinery disclaims any real or implied warranty and holds itself harmless for any injury or damage which may result from that use.
13. **ADDITIONAL SAFETY INFORMATION:**
  - National Safety Council – *Accident Prevention Manual for Business and Industry*: <https://shop.nsc.org/apm-admin-program-14ed>
  - ANSI O1.1: <https://webstore.ansi.org/standards/wmma/ansio12013>
  - OSHA 1910.213: <https://www.osha.gov/laws-regs/regulations/standardnumber/1910/1910.213>

## Safety Guidelines Specific to Sander

### Before Work Begins:

1. Press the “OFF” switch button before connecting the sander to a power source. This reduces the risk of unintentional starting. Make sure the machine is unplugged before changing spindles or making any adjustments.
2. Inspect the sanding sleeve for signs of failure. Clean clogged sanding sleeve with abrasive cleaning stick. Replace damaged, overstretched, or worn sanding sleeves.
3. Ensure the sanding sleeve is held securely on the spindle. If the sleeve has lost grip on the spindle, refer to the section “Changing Sanding Sleeves” on page 29 to secure the sanding sleeve.
4. Inspect the workpiece. Do not process workpieces with loose parts and/or containing dangerous chemicals. Do not sand wood with high moisture content.
5. Remove and confine any personal belongings that can get caught and entangled with the spindle. Remove tie, rings, watch, and other jewelry. Roll up sleeves above the elbows. Remove all loose outer clothing and confine long hair. Do not wear gloves while sanding. Wear protective footwear.
6. Use a correctly sized table insert to minimize the gap between the spindle and the insert.
7. Sanding creates a lot of dust. Connect this sander to a dust collection system and wear a high-quality dust mask.

## When Sanding:

1. Maintain control of the workpiece:
  - Feed the workpiece against the rotation direction of the spindle.
  - Hold the workpiece firmly with both hands and apply light pressure against the sanding spindle.
  - Use the table to support the workpiece.
2. Keep hands away from the gap between the sanding spindle and the table. Use special jigs to hold down small workpieces as needed.

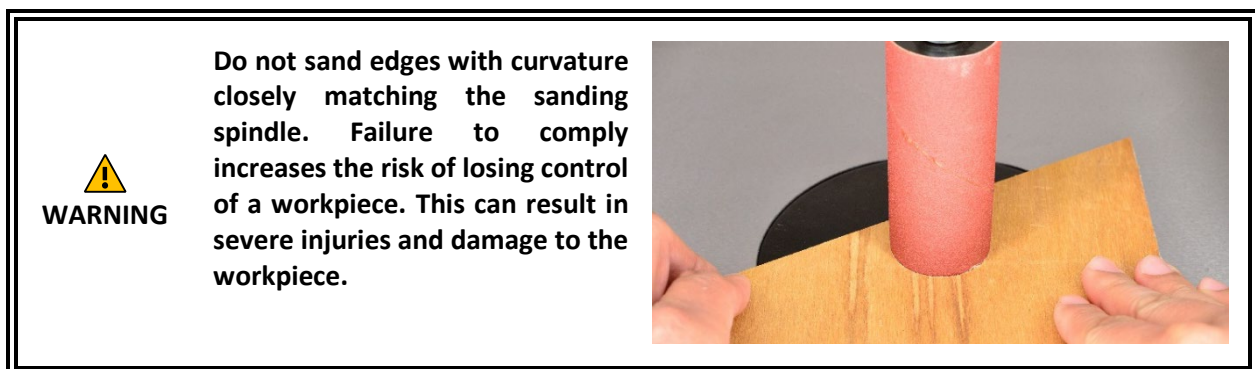
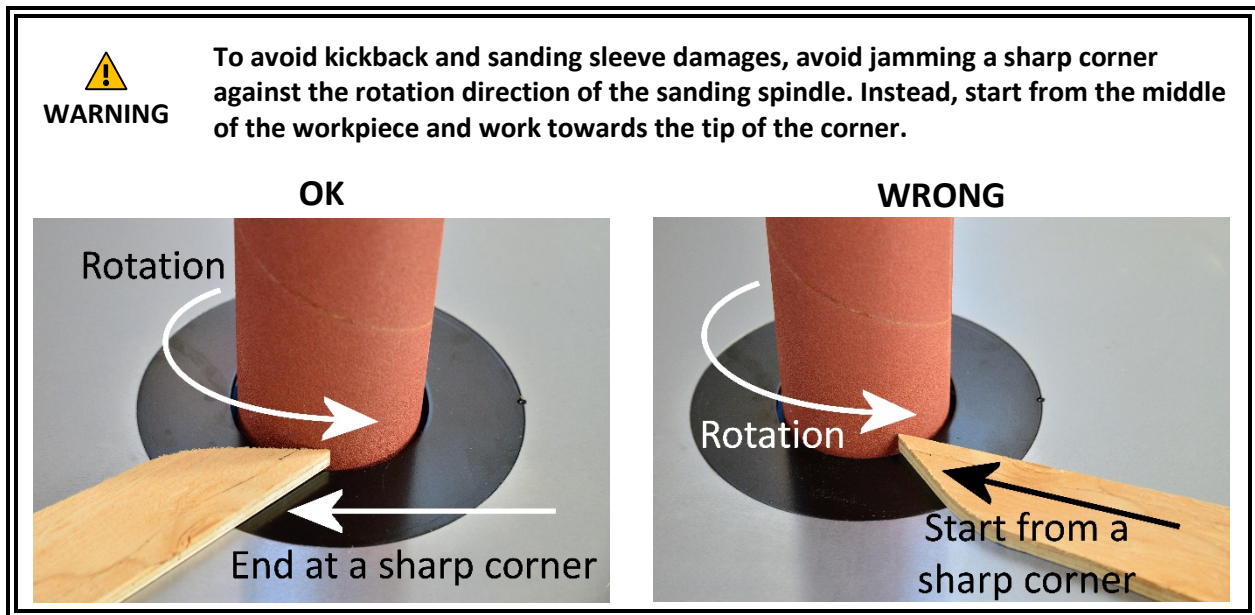

## After Operation

1. STOP THE MACHINE when the operator leaves the machine for any reason.
2. WAIT until the motor comes to a complete stop.
3. CLEAN UP before departure.

# Electricals

 <b>WARNING</b>	<b>All electrical work must be done by a qualified electrician and must meet the electrical code in your area.</b>
---	--

### Minimum Circuit Size Required for Model 6910 Sander

<b>Stock Number</b>	<b>Voltage</b>	<b>Minimum Circuit Size Required</b>
6910.003	115V	20A
	230V	15A

Please ensure the electrical circuit for this machine meets the minimum circuit size requirement. The minimum circuit size requirement applies to a dedicated circuit that provides power to one 6910 Sander. If more machines are sharing the same circuit, consult a qualified electrician to ensure the designated circuit is properly sized for safe operation.

If a circuit is available, but not meeting the minimum circuit size requirement listed above, a new circuit must be installed for this machine.

### Grounding

 <b>WARNING</b>	<b>Improper grounding can cause electric shock, fire, and equipment damage.</b>
---	---

Proper grounding reduces the risk to the operator in the event of electrical malfunction or breakdown. This machine must be connected to the grounding conductor when available, and all grounding connections must meet or exceed the electrical code requirements in your area. Furthermore, all grounds must be verified and must meet or exceed the electrical requirement of the machine. If grounding is not available, consider the use of a GFCI protection device as an alternative, if this complies with the electric code in your area.

### Indoor Use Only

This machine is designed for indoor use only. Operating this machine outdoor increases its exposure to moisture, which in turn increases the risk of electric shock.

## Electrical Wiring

This machine is pre-wired for 115V, with a cord and a NEMA 5-15 plug. This sander can be rewired for 230V operations. Refer to section “Wiring Diagram” on page 35 for rewiring this machine, and use a 230V compatible plug such as NEMA 6-15.

Use of extension cord is not recommended. If you need to use an extension cord to connect to a power source, select a durable cord type with a high-temperature rating (90C° or above). Use the minimum amount of extension cord as needed.

### Minimum cord size (AWG) required based on amperage draw and length of the cord:

<i>Amps</i>	<b>Power Cord Length</b>			
	25 feet	50 feet	75 feet	100 feet
<i>5 to 8</i>	14	14	14	12
<i>8 to 12</i>	14	14	12	10
<i>12 to 15</i>	12	12	10	10
<i>15 to 20</i>	10	10	10	NR
<i>21 to 30</i>	10	NR	NR	NR

\*NR: Not Recommended



**Use properly sized wires that meet or exceed the power requirement of your machine. Using undersized wires may cause overheating and increase the risk of fire and machine damage.**

# Setup

## Shop Preparation

### Space Requirement

The dimensions of this machine are 27“(L) x 25”(W). You will need additional space for manipulating your workpiece, electrical connection, and dust collection.

### Load Limits

This machine has a shipping weight of 319 lbs., and a net weight of 286 lbs. Please ensure all lifting tools and building structures have adequate load capacity, for transporting and supporting the total weight of this machine, the operator, and related items.

### Electricals

Make sure a properly sized circuit and electrical outlet are available near the machine. Please refer to section “Electricals” on page 13 for details regarding electrical requirements.

### Lighting

Adequate lighting is needed for operating this machine. Overhead, non-glare lighting should be installed.

### Safety Labels

If this machine introduces a new safety hazard to your workplace. Please display proper warning signs in a highly visible location(s).

### Dust Collection

Wood dust created by this sander is a health hazard. High-quality dusk masks should be available for using the sander.

Connect this machine to a dust collection system. Check air suction strength regularly to ensure wood dust is effectively removed.



**CAUTION**

**Air resistance and leakage in a dust collection system impact its effectiveness. Use a dust collection system that is rated above 300 CFM at the dust port. Doing so improves air quality in the workplace, and prevents the machine from jamming.**

## Receiving

Your shipment should come in one package. Upon receiving your shipment, check for any significant damages before signing the delivery confirmation.

### **IMPORTANT**

If items are damaged, please call us immediately at **1-800-559-5065**



Always wear safety goggles and gloves before removing the straps. Straps may spring back violently when released and cause injury.

## Moving Machine into the Shop

On the day of delivery, please be sure help is available to move the machine to its final location.



6910 Sander has a gross weight of 319 lbs. and a net weight of 286 lbs.

Safe moving techniques and proper lifting equipment are required, or serious personal injury may occur.



Your machine may be secured by the straps. Do not lift your shipment by the strap. They are not designed to hold the total weight of your shipment. They may snap without warning and cause serious injury and machine damage.

## Unboxing

The sander is shipped with a pallet and protected by double-layered card boxes and plastic wrappings. It also comes with a box with loose parts and accessories.



**IMPORTANT:** Have one person hold the cast iron table in place while unwrapping the package to prevent the table from tipping over.



## Inventory

Carefully unwrap the packaging and make sure all components are included in the shipment. Lay out the unassembled parts received and inventory them.



**The cast iron table is very heavy and will require two or more strong adults to install. Use safe moving techniques and proper lifting equipment are required, or serious personal injury may occur.**

**Package 1:** Large sanding spindles with sleeves already installed (4", 3", 2", 1-1/2", 1")

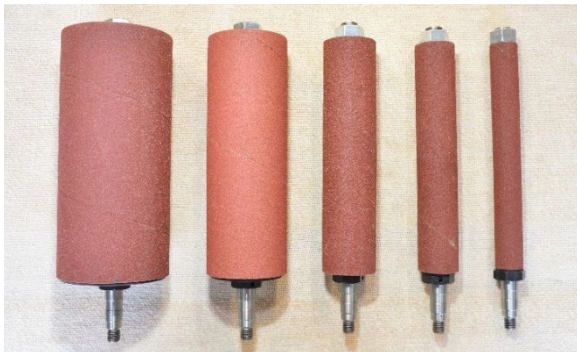

**Package 2:** Small sanding spindles and sanding sleeves (3/4", 5/8", 1/2", 3/8", 1/4")

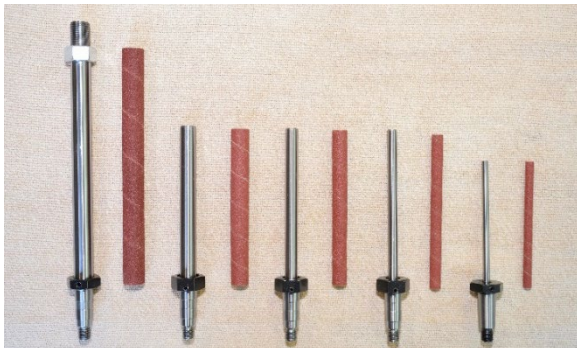

**Package 3:** Table Inserts

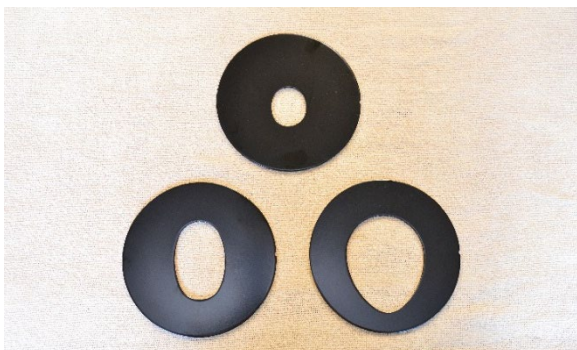

**Packaged 4:** Cast Iron Table

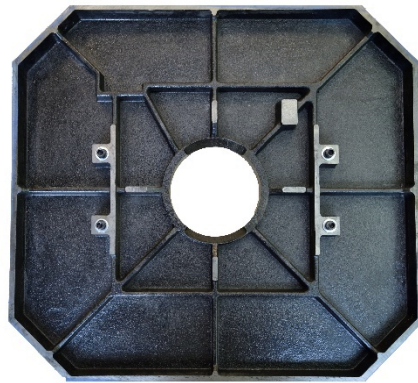

**Package 5:** Wrenches

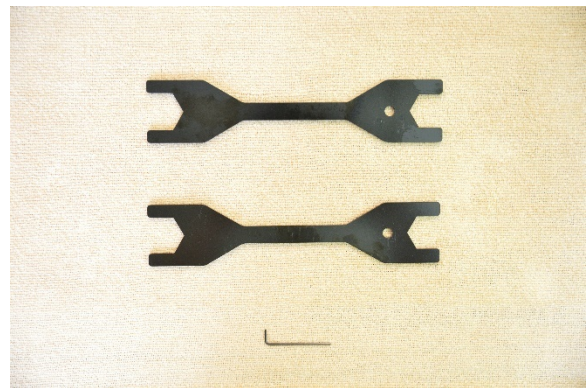

- 29/32mm Wrenches (2x)
- 2mm Hex Wrench

## Cleaning

To prevent rusting during shipment, the unpainted cast iron tabletop is covered with rust protectant and plastic film. Remove the plastic film and wipe off the rust protectant with paper towels. WD-40 can thin the rust protectant and make cleaning easier. Do not use harsh solvents such as acetone which can damage the paint, and **NEVER** use gasoline or any highly flammable solvents as degreaser.

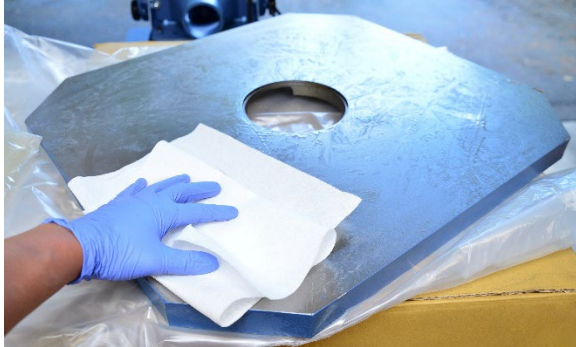

Once all rust protectant is removed, routinely coat the tabletop with rust preventive such as Boeshield® T-9 or paste wax. Do not use rust preventives that contain silicone, which is known to interfere with certain finishes and glues.

The smaller spindles that come with the sander are also covered in machine oil. Wipe off the machine oil before installing the sanding sleeves.



## Removing Machine from Pallet

When all items are ready for setting up the machine, gently move the machine off from the pallet.

The cabinet of the sander is mounted on the pallet to prevent shifting during transport. Remove the brackets before lifting the machine.



**Never use gasoline or any highly flammable chemicals as degreaser. These chemicals can cause fire and explosion.**

**Discard oily rags in a fireproof container and keep them away from combustible materials. Oily rags can heat up and trigger spontaneous combustion under certain conditions.**

## Assembly

### Table Installation

1. Flip the table upside down. Identify the front and the rear edge of the table using the ground surface (0° positive stop). Then remove the mounting cap screws and washers.

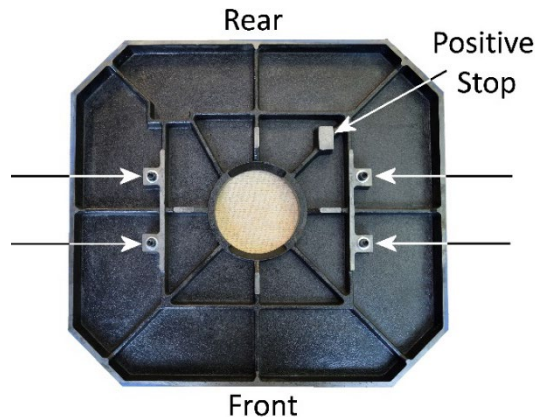

2. Fasten both table tilt locks, so the trunnion is locked when the table is installed.

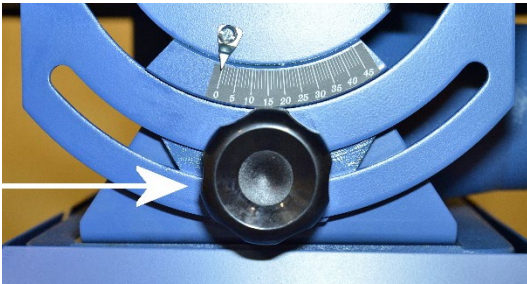

3. Place the table on the trunnion and align the screw holes. Reinstall the cap screws and the washers, but do not fully tighten the screws yet.

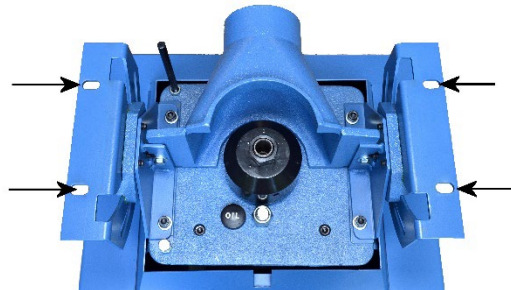

4. Align the table so the quill sits at the center of the table opening.
5. Use an 8mm hex wrench to fasten all four mounting cap screws to secure the table on the trunnion.

### Sanding Sleeves Installation

1. Push the sanding sleeves into the spindle. New sanding sleeves can be a bit tight. Lightly tap it into the spindle as needed.

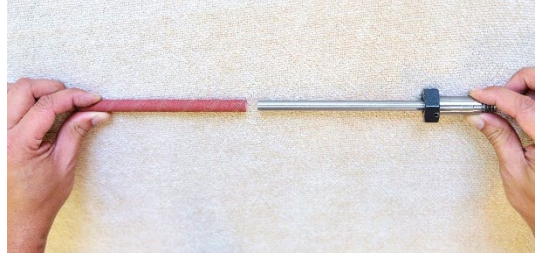

2. For the four small sanding spindles, secure the sanding sleeve by tightening the set screw with a 2mm hex wrench.



3. The 3/4" spindle has a locking nut located at the top. Hand-tighten the nut to secure the sanding sleeve.

**IMPORTANT:** Do not over tighten this nut as this can damage the sanding sleeve.



4. Try pulling the sanding sleeve away from the spindle to make sure it is securely mounted onto the spindle.

## Sanding Spindle Installation/Removal

1. **Disconnect sander from the power source!!**
2. Use the provided spindle wrenches for this step. Remove the table insert if it is installed.



3. Make sure the contact surface between the spindle and the quill is clean. Any debris or grime build-up can impact the balance of the spindle.



4. Thread the spindle clockwise into the quill and hand-tighten.

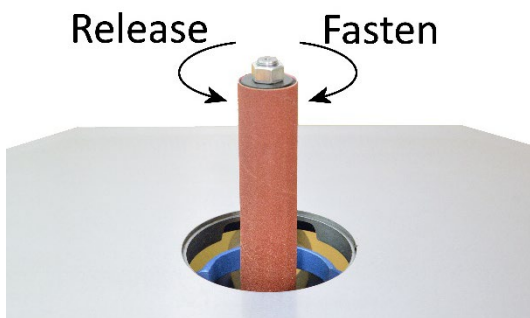

5. The quill is secured by two nuts: The upper and the lower quill nuts.

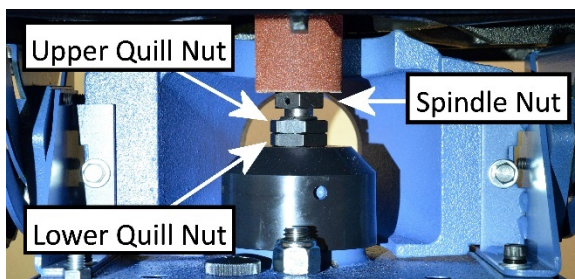

6. To fasten the spindle, use one wrench to hold the lower quill nut in place, then tighten the spindle with another wrench by another 1/8 of a turn clockwise.

### IMPORTANT

The spindle is self-tightening when the sander is in operation. Do not overtighten the spindle or the spindle can be difficult to remove later on.

7. Choose an insert that forms a small gap with the sanding spindle. Leaving a big gap between the table and the spindle will reduce the support of the workpiece, making it more difficult to control.

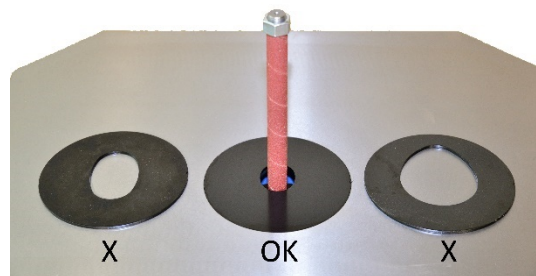

NOTE: The 4" sanding spindle is too big for any table inserts provided, and it can be used without table inserts.

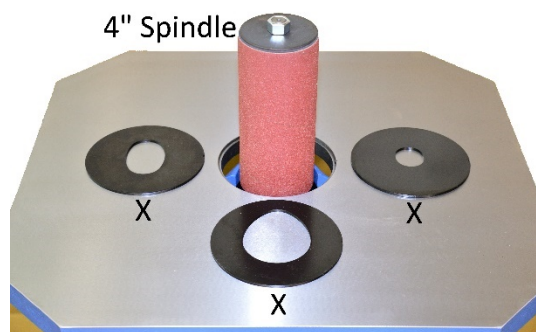

### ⚠️ WARNING

Make sure to use an insert that leaves at least a 3/16" gap with the spindle. If the insert catches the spindle, the insert may dislodge from the table and cause serious injuries.

8. Install the table insert. Orient the insert so one side with a thinner rim aligns with the rear end of the table. This allows extra clearance for bevel sanding.

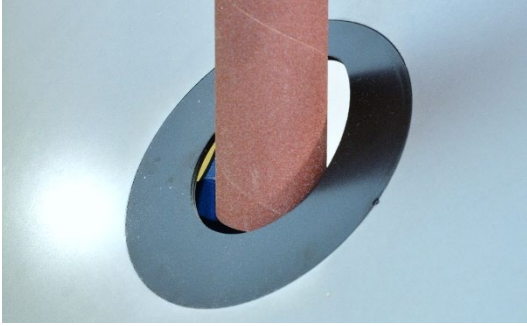

9. Make sure the notch on the outer edge of the insert aligns with the pin on the table opening, and the entire insert is flush with the table.

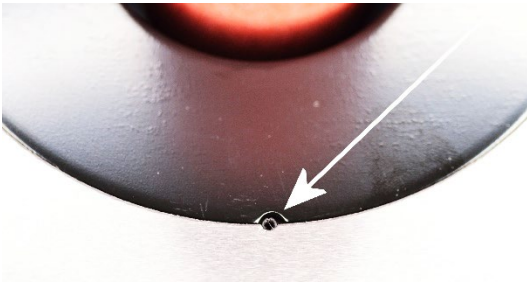

10. Clear the table before starting the sander.

### To Remove the Spindle

1. **Disconnect sander from the power source!!**
2. With one wrench holding the upper quill nut in place, rotate the spindle nut counterclockwise to loosen it from the quill.
3. Continue to rotate the spindle by hand until the spindle breaks apart from the quill.

#### **IMPORTANT**

Remove the spindle after each use and keep the machine in a dry place. The spindle can bind to the quill if rust forms.

## Spindle and Table Insert Storage

Store the spindles and table inserts in the storage areas when they are not in use.



## Dust Collection

Sanding can generate a lot of dust. Connect this machine to a dust collection system.

The minimum CFM requirement for this sander is 300 CFM at the dust port, which means the dust collection system should have a rating greater than 300 CFM, as air friction and leakage can reduce the effective CFM at the dust port.

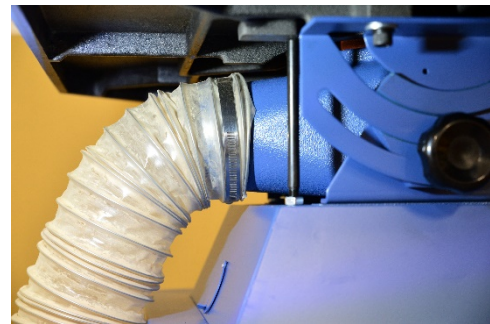

### **IMPORTANT**

Running this sander without a dust collection system, or using a dust collection system with inadequate suction may damage the machine and cause other hazardous situations. Check your dust collection system regularly to make sure it is not jammed or filled up.

# Test Run

Before putting this sander in use, please complete the following tests to ensure the sander is fully functional and is calibrated for operation. If you discover any issues from the tests, please refer to the maintenance section on page 28 and the troubleshooting section on page 33 for troubleshooting and adjustments.

## Table/Spindle Alimint Check

1. Install a sanding spindle and a matching table insert.
2. Set the table tilt to zero degrees. The positive stop should stop the table when the pointer on the tilt scale points at 0°
3. Use a square to make sure the spindle is perpendicular to the table.
4. Slope down the table to 45 degrees. The positive stop should stop the table while the pointer on the tilt scale points at 45°.
5. Use a protractor to make sure the table forms an angle of 135° with the spindle.



## Electrical/Mechanical Components Test

1. Through the oil level window access, make sure the gearbox oil level is between the high and the low mark. If the oil level appears to be low, top off the gearbox with 90 SAE gear lube.

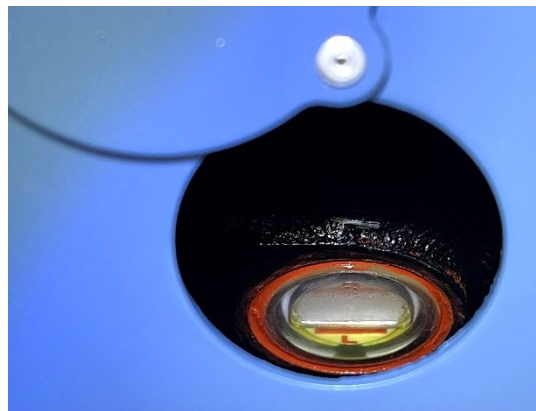

2. Press the "OFF" button to ensure the sander is switched off, then connect the sander to a power source.
3. Put on personal protection devices.
4. Press the "ON" button to turn on the sander. The motor should run and the spindle should oscillate.
5. Press the "OFF" button to turn off the machine when testing completes.

# Operation

## Preparation before Sanding

### Material Selection and Inspection

This machine is primarily designed for sanding good quality natural wood materials. Avoid cracked stock and boards with loose knots that can break apart and cause severe injuries. Using this sander for other material types may damage the sanding sleeve or shorten its lifespan, and may cause other hazardous situations. For example, sanding ferrous metals can create sparks, and that can ignite flammable materials nearby.

Do not sand treated lumber or anything that contains harmful chemicals, as this will spread dust that contains such harmful chemicals.

Carefully inspect the workpiece for foreign objects. Nails, staples, rock chips, and other objects embedded on the wood surface can damage the sanding sleeve. Clean the workpiece with a stiff brush as needed.

Glue on the workpiece can gum up the sanding sleeve. Scrape off all excess glue before sanding.

The bottom of the workpiece should be flat so it can be pushed firmly against the table for feeding. If a workpiece does not have a flat bottom, it should be handled with a special jig so it can be fed steadily against the sanding spindle.

### Supporting Large Workpiece

Supporting large workpieces with auxiliary table or roller to avoid injuries. This also helps to create a consistent finish.

### Safety Devices

To reduce the chance of a workpiece getting pulled out of your hand, and to avoid accidental contact of the moving sanding spindle, use a special jig/hold-down in these situations:

1. If the operator cannot safely feed the workpiece by keeping the hands at least 4" away from the sanding spindle.
2. The workpiece has an odd shape that cannot be fed by hand securely/steadily.

Always wear high-quality dust masks when operating the sander.

### Clear the Work Area

Before turning on the sander, make sure the sander table is free of debris, and the workpiece is not engaging the spindle.



## Table Tilt Adjustment

1. **Disconnect sander from the power source!!**
2. Remove the table insert and clear the table.

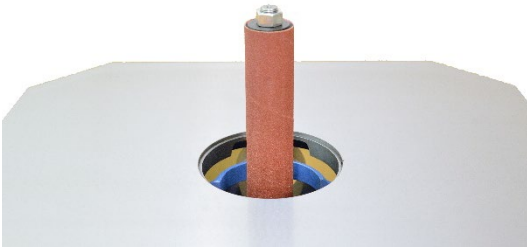

3. Loosen the table tilt lock on both sides of the machine.

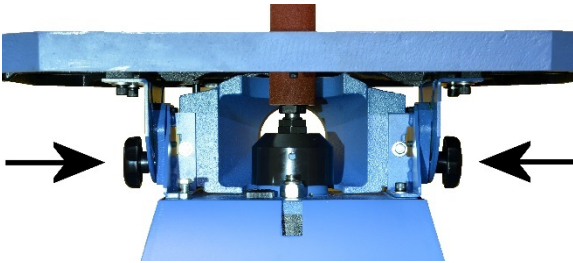

4. Use the table tilt scale for setting the tilt angle.



5. Tighten both table tilt lock knobs.
6. Install a table insert. Choose the insert that forms a small gap no less than 3/16" with the spindle.

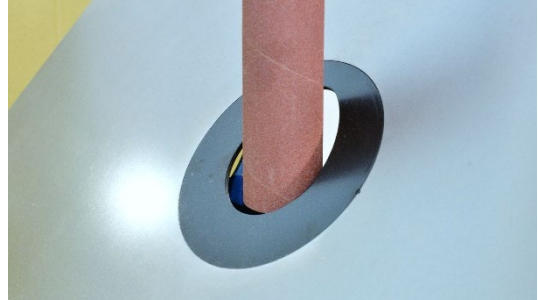

### **WARNING**

Make sure to use an insert that leaves at least a 3/16" gap with the spindle. If the insert catches the spindle, the insert may dislodge from the table and cause serious injuries.

## 90° Sanding

1. Move the table to the 0° position to create a squared edge. Tighten the table tilt locks.

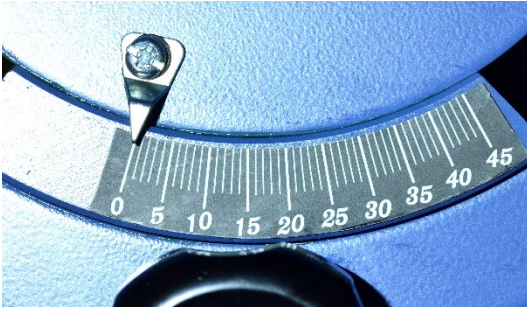

2. Install a properly sized table insert. The insert should form a small gap with the spindle that is no less than 3/16"

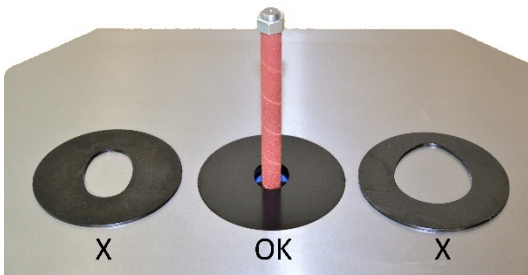

3. Before starting the sander, clear the table and turn on the dust collection system.
4. Turn on the sander.
5. Hold the workpiece firmly on the table. Feed the workpiece gently against the rotation direction of the sanding spindle.

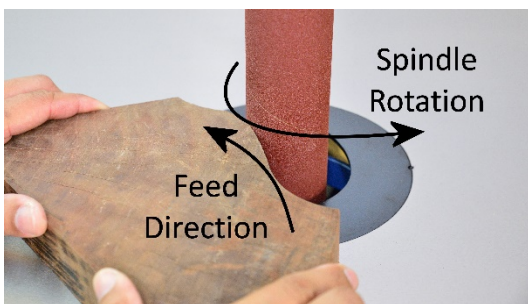

## Bevel Sanding

1. Adjust the tilt angle of the table.
2. When applicable, install a table insert to reduce the gap between the sanding spindle and the table.
3. Turn on the dust collection system and turn on the sander.
4. Hold the workpiece firmly on the table. Feed the workpiece gently against the rotation direction of the sanding spindle.
5. To create a bevel with the desired angle, engage the workpiece at the spot where the spindle meets the lowest point of the sloped table as shown in the picture below.

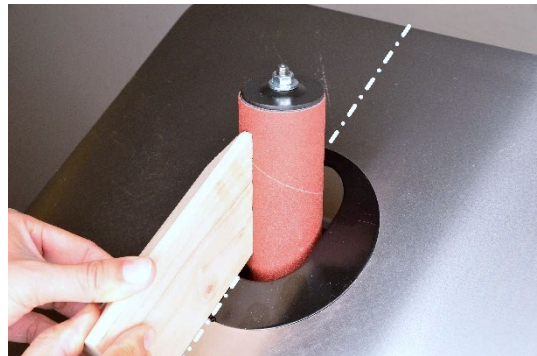

6. **IMPORTANT:** Engaging the workpiece in any other locations of the spindle creates an edge with an incorrect angle.

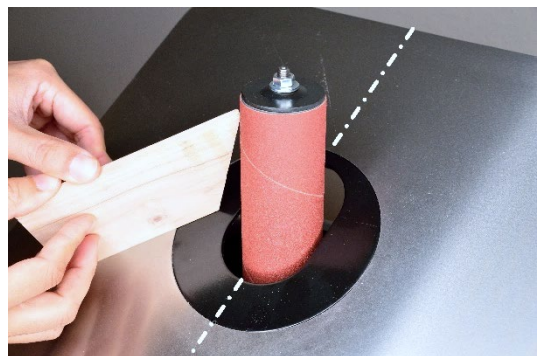

# Accessories

## Sanding Spindles

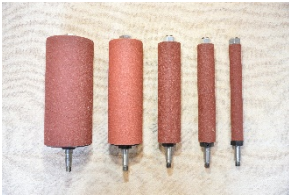

Purchase multiple spindles to allow sanding with various grits without changing the sanding sleeves frequently.

All optional sanding spindle assemblies will ship with a sanding sleeve.

3010500GA	1/4" x 5"
3010500GB	3/8" x 6"
3010500GC	1/2" x 6"
3010500GD	5/8" x 6"
3010500GE	3/4" X 9"
3010500GF	1" X 9"
3010500GG	1-1/2" X 9"
3010500GH	2" X 9"
3010500GI	3" x 9"
3010500GJ	4" x 9"

## Touchup Paint



Keeping all painted surfaces in good condition not only makes your machine look nice but also keeps rusts away. Oliver Machinery has pre-mixed spray paint available in Oliver-Blue for purchase.

Accessories are available on our website: [OLIVERMACHINERY.NET](http://OLIVERMACHINERY.NET)

To order by phone, please call us at **1-800-559-5065**. We are available Monday through Friday, 7:30 AM to 4 PM Pacific Time. You can also email us at [PARTS@OLIVERMACHINERY.NET](mailto:PARTS@OLIVERMACHINERY.NET) to purchase accessories.

Please visit our website at [OLIVERMACHINERY.NET](http://OLIVERMACHINERY.NET) for additional recommended accessories.



**WARNING**

**Using unapproved accessories may cause the machine to malfunction, which can result in serious injury and/or machine damage. Only use accessories recommended for this machine.**

# Maintenance

Routine maintenance keeps your sander in optimal condition. Please follow the maintenance schedule below, and use the maintenance record worksheet attached in the back of the manual to document all tasks completed.

**NOTICE:** Maintenance schedule may vary for individual users due to different situations and safety requirements.

Task	Frequency
Inspect the sanding sleeve for signs of failure.	Every time before any operation begins.
Inspect power switch, cord, and plugs for signs of failure.	Every day before any operation begins.
Clean sanding sleeve with abrasive cleaning stick.	When the sanding sleeve is clogged.
Remove dust accumulated on the machine.	Weekly
Apply rust protectant on cast iron tables.	Monthly
Replace gearbox oil.	After the first 50 hours of use, then every 800 hours thereafter.

 <b>WARNING</b>	<b>Disconnect the machine from the power source before any maintenance work is performed. After servicing the sander, remove all tools before restarting the machine. Failure to comply can cause serious injury!</b>
---	---

## Cleaning Sanding Sleeves

Cleaning the sanding sleeves regularly with an abrasive cleaning stick. This helps to remove dust and grime that clogs the abrasive surface. Doing so extends the life of the sanding sleeves and avoids low-quality results.

To clean a sanding sleeve, turn on the sander and hold the cleaning stick lightly against the spindle.

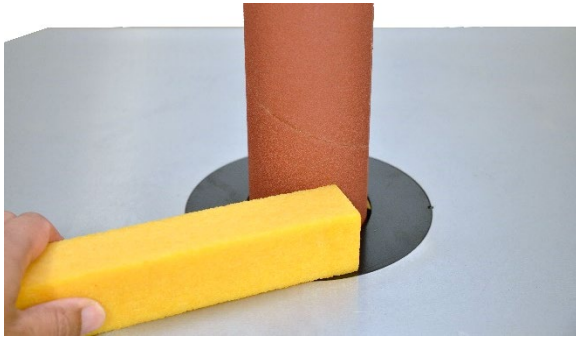

### **IMPORTANT**

Replace the sanding sleeve when it is worn. Using worn sanding sleeves may leave burn marks on the workpiece and produce an imperfect finish.

## Changing Sanding Sleeves

Remove the spindle from the sander before changing the sanding sleeves. See section "Sanding Spindle Installation/Removal" on page 19 for details.

### **For Small Spindles of Size 1/4" to 5/8"**

1. Loosen the sanding sleeve set screw.



2. Replace the sanding sleeve. If the sanding sleeve wraps very tightly around the spindle, it may need to be cut out. A new sanding sleeve can be tight. Lightly tap it into the spindle as needed.

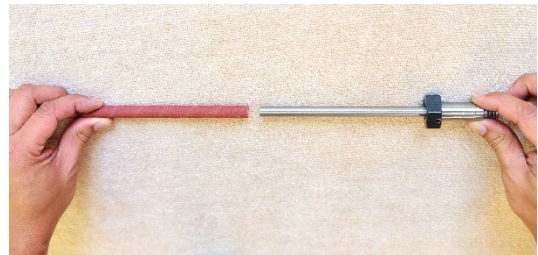

3. Retighten the sanding sleeve set screw to secure the sanding sleeve.
4. Try pulling the sanding sleeve away from the spindle to make sure it is securely mounted onto the spindle.

### For the 3/4" Spindle:

1. Use a 26mm wrench to loosen the nut that sits at the top of the spindle.

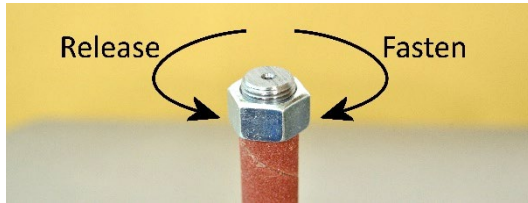

1. Replace the sanding sleeve.

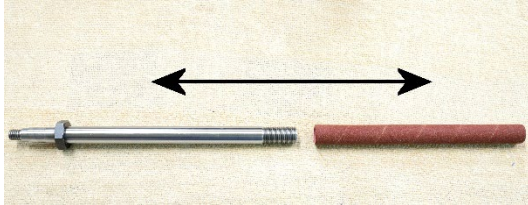

2. Reinstall and hand-tighten the nut until the sanding sleeve is fastened in place.

**IMPORTANT:** Do not over tighten the nut that holds the sanding sleeve. Over-tightening the nut can cause the sanding sleeve to deform and detach from the metal spindle.

### Large Spindles of Size 1" – 4":

2. Use a 26mm wrench to loosen the nut that sits at the top of the spindle.

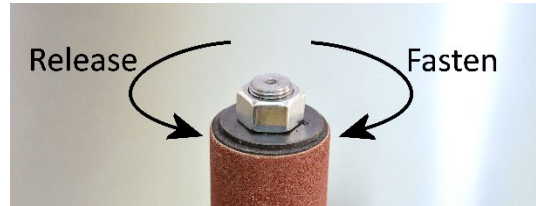

3. Replace the sanding sleeve.

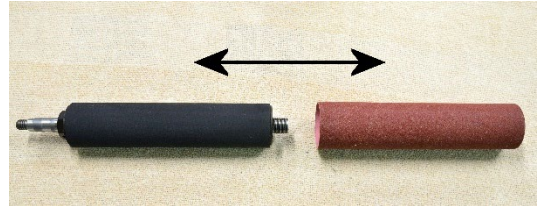

4. Reinstall and rotate the nut until the sanding sleeve is fastened in place.

**IMPORTANT:** Do not over tighten the nut. The nut compresses the rubber column that holds the sanding sleeve by friction. Over-tightening the nut can cause the sanding sleeve to deform, overstretch, or disintegrate.

## Table Positive Stops Adjustment

1. **Disconnect sander from the power source!!**
2. Loosen the table tilt locks.
3. The 0° positive stop is located on the rear side of the sander:

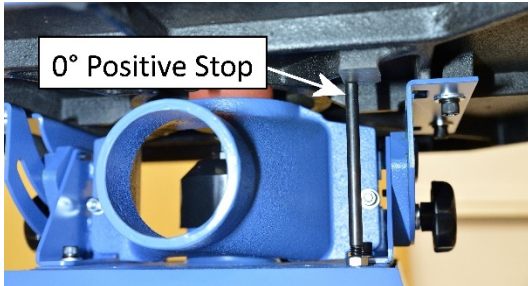

4. Loosen the jam nut of the stop rod.
5. Place a square against the sanding spindle and the table. Adjust the height of the stop rod until the table is perpendicular to the spindle while it is pushing against the stop rod.

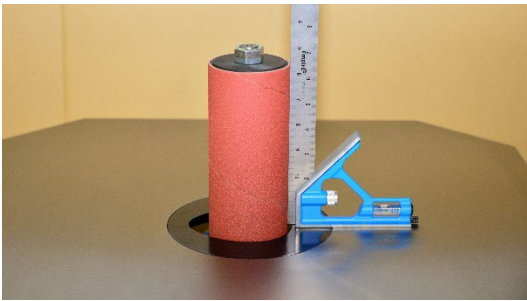

6. Hold the stop rod firmly and then tighten the jam nut.
7. Re-check the squareness of the table against the spindle. Repeat steps 4-6 as needed.
8. Make sure the pointer of the table tilt scale is now pointing at 0°. If the pointer needs to be adjusted, loosen the screw to readjust the pointer's position.

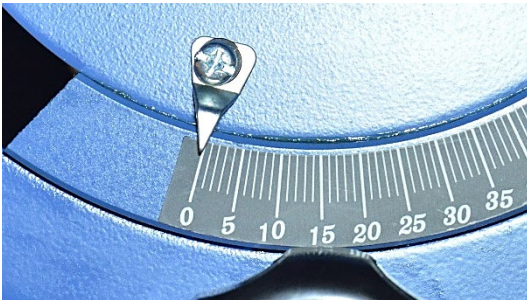

9. The 45° positive stop is located on the front side of the sander, and it can be adjusted using the stop bolt as shown in the picture below:



10. Fasten the table tilt locks after adjustments.

## Lubrication

### Gear Lubricant Replacement

The gearbox of the sander contains two quarts of 90 SAE gear lube, and it needs to be replaced regularly. Replace the lubricant after the first 50 hours of use, and then every 800 hours of use thereafter.

1. **Disconnect sander from the power source!!**
2. Gather a container that is large enough to collect 2 quarts of used oil.
3. Open the motor access panel, and locate the drain plug.

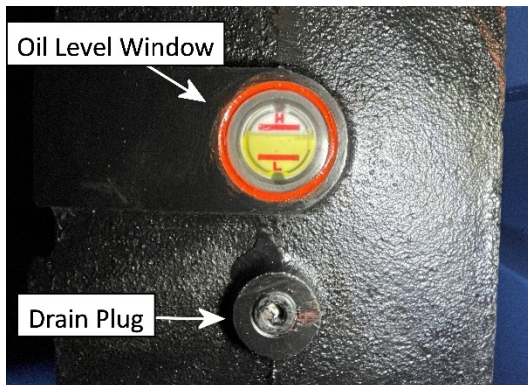

4. Use a 6mm hex wrench to remove the drain plug. Reinstall the drain plug after the old lubricant is drained.
5. Remove the oil cap that is located below the table, then fill the gearbox with approximately two quarts of 90 SAE gear lube. Monitor the oil level window while filling the lubricant. The oil level needs to be between the high (H) and the low (L) marks.

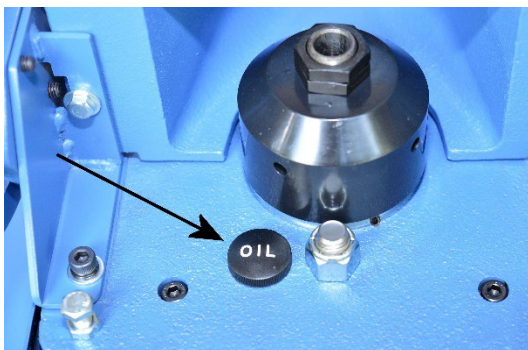

6. Reinstall the oil cap when the oil change is done.

### Spindles

Keep the spindles clean and dry. To prevent rust, the arbor of the sanding spindle can be lubricated very lightly with lightweight machine oil.

### Bearings

All bearings are permanently lubricated and do not require lubrication.



# Troubleshooting

## Mechanical / Electrical Issues

Problem	Possible Cause	Solution
<b>Machine will not start</b>	Not connected to a power source.	Make sure the machine is plugged in. Check the electrical panel for a tripped circuit breaker or a blown fuse. Ensure all electrical connections have good contacts.
	Low voltage / current.	Have an electrician check/repair the power circuit.
	Faulty switch/motor/capacitor.	Contact customer service for further assistance.
<b>Machine stopped during the operation.</b>	Tripped circuit breaker or blown fuse.	Reconnect the circuit. Reduce feed pressure.
<b>Circuit breaker trips frequently</b>	Feeding stock too quickly.	Feed the stock more slowly and gently.
	Extension cord too light or too long.	Use a shorter / heavier cord that meets this machine's electrical requirements.
<b>Machine stalls or does not come up to speed</b>	Extension cord too light or too long.	Use a shorter / heavier cord that meets this machine's electrical requirements.
	Feed pressure too high.	Reduce feed pressure.
	Motor/capacitor issue.	Contact customer service for further assistance.
<b>Machine vibrates excessively</b>	Machine stands on an uneven surface.	Reposition machine on a flat, level surface.
	Damaged spindle	Ensure the spindle is straight and balanced, and it is not cross-threaded.
	Spindle was not installed correctly.	Ensure the spindle is securely fastened on the quill.
	Worn/broken sanding sleeve.	Replace sanding sleeve.
	Improper motor/component mounting.	Check, adjust, and tighten motor/component mounting.
	Motor bearing issue.	Contact customer service for further assistance.

## Operation / Quality-Related Issues

Problem	Possible Cause	Solution
<b>Work pulled from the hand</b>	Inadequate stock support.	Hold work firmly against the sanding belt. Use a special jig to support small stock or stock without a flat bottom.
	The sanding spindle is not perpendicular to the table.	Adjust the table tilt. Adjust the table stop bolt as needed.
<b>Sanded edge is not squared</b>	Improper stock feeding.	Ensure stock is pressed firmly against the table when feeding.
	Incorrect table tilt angle.	Adjust the table tilt with a protractor. Adjust the table tilt scale pointer as needed.
<b>Incorrect bevel angle</b>	Engaging workpiece at a wrong position on the table.	Engage the workpiece at the spot where the spindle meets the lowest point of the sloped table.
	<b>Stock burns</b>	Sanding grit is too fine. Use a sanding sleeve with a coarser grit.
<b>Sanding sleeve clogs easily</b>	Clogged/worn sanding belt.	Use sanding belt cleaner to unclog the sleeve. Replace the sanding sleeve as needed.
	Feed pressure too high.	Lower feed pressure.
	Sanding softwood or wood with high resin content.	Clean/replace the sanding sleeve more frequently.
<b>Deep sanding marks on the workpiece</b>	Sanding wet stock.	Dry stock before sanding it.
	Sanding non-wood materials.	Some materials may melt easily when heated. Sand with light pressure and keep it cool when sanding.
	Sanding sleeve grit is too coarse.	Use a finer grit sanding sleeve.
<b>Abrasive materials rub off the sleeve easily</b>	Dirty/contaminated sanding sleeve.	Clean sanding sleeve. Replace as necessary.
	Too much feed pressure and/or abrupt feeding.	Reduce feed pressure and allow more time for the abrasive surface to work on the workpiece.
<b>Abrasive materials rub off the sleeve easily</b>	Aged sanding sleeve.	Avoid storing sanding sleeves in extreme temperature and humidity which may cause the sleeve to fail prematurely. Do not fold or smash the sanding sleeve as it may disintegrate the bonding material on the sleeve.

# Wiring Diagram

Single Phase 115V

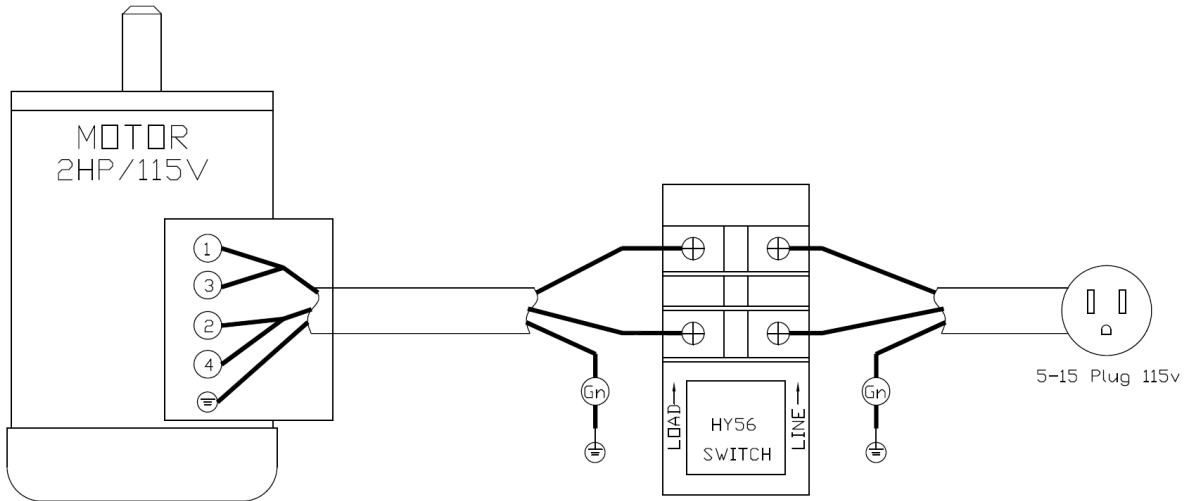

Single Phase 230V

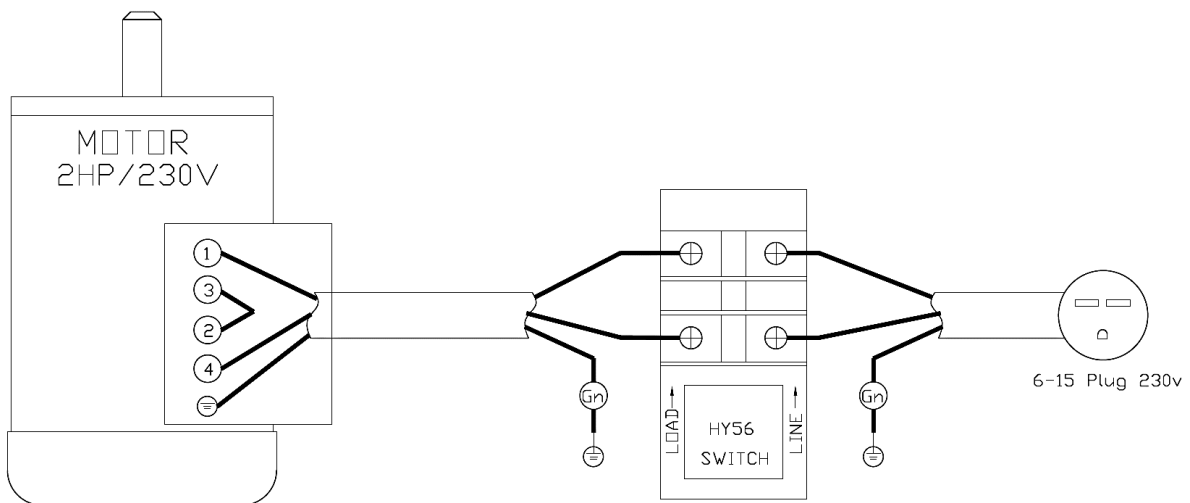

**DANGER**  Deenergize the electrical circuit before touching any enclosed, electrified parts. Touching an electrified part WILL result in serious personal injury or death.

**WARNING**  All electrical work must be done by a qualified electrician and must meet the electrical code in your area.

# Parts List

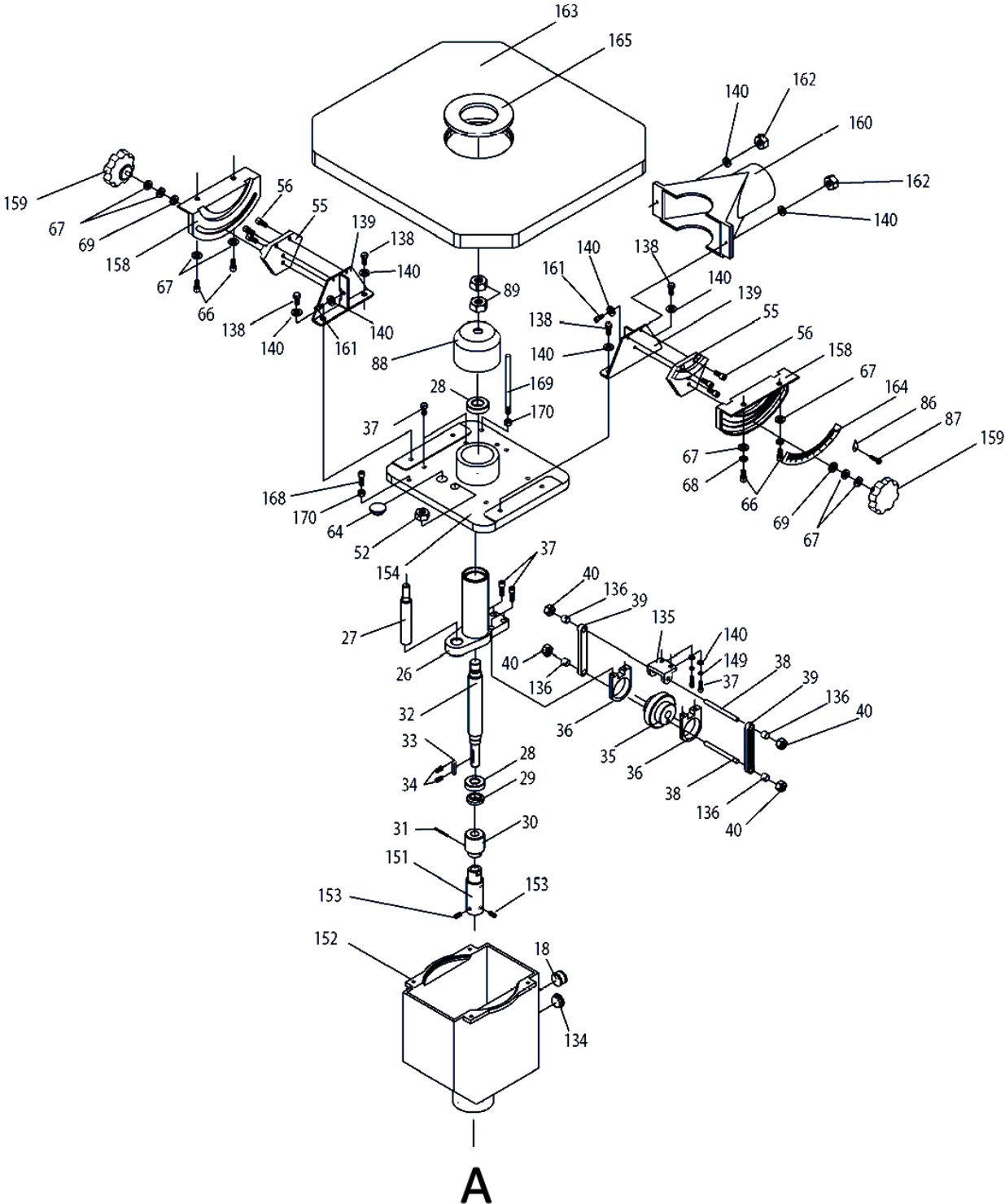

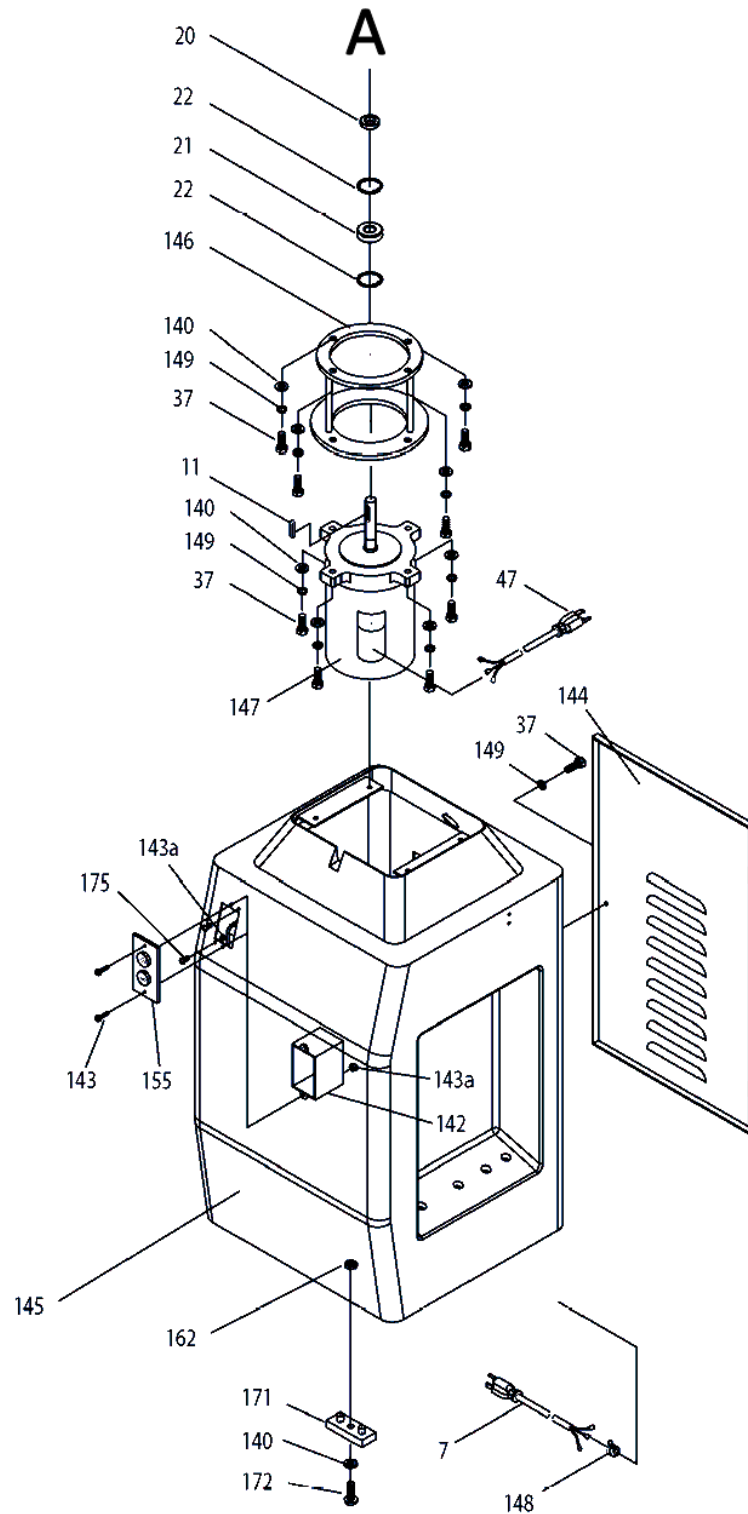

Index	Part Number	Descriptions	Specifications	QTY
7	L0000037	POWER CORD	14AWG*3C 1R2Y	1
11	S0400525	MOTOR KEY	5*5*25m/m	1
18	30101011	OIL INDICATOR		1
20	30101014	OIL SEAL	62*29*8MM	1
21	C1106206	BALL BEARING	6206ZZ	1
22	S0530025	C SNAP RING	R-25	2
26	30103014	SLEEVE		1
27	30103015	GUIDE RAIL SHAFT		1
28	C1206205	BALL BEARING	6205LLU	2
29	30103016	LOCKING NUT	15"/16	1
30	30103017	WORM GEAR		1
31	S0310530	SPRING PIN	5*30	1
32	30103018	MAIN SHAFT		1
33	S0400550	KEY	5*5*50	1
34	S0010210	SET SCREW	1/8"*40W*5/8"	1
35	30103019	SPUR GEAR		1
36	30103020	BRASS BUSHING		2
37	S0010501	HEX SOCKET CAP SCREW	5/16"*18UNC*1"	4
38	30103021	TRANSMISSION ROD SHAFT		2
39	30103022	TRANSMISSION ROD		2
40	S0110600	LOCKING NUT	3/8"-16UNC	4
47	L0000000	SWITCH CORD		1
52	S0120580	LOCKING NUT	24*24*19MM	1
55	30101029	TRUNNION BRACKET		2
56	S0010510	HEX SCREW	5/16"*18UNC*5/8"	6
64	30101035	OIL CAP		1
66	S0010610	HEX SOCKET CAP SCREW	3/8"-16UNCx5/8"	4
67	S0210600d	WASHER	3/8*22*0.7	4
86	40301032	SCALE POINTER		1
87	S0030304	SCREW	3/16"*24UNC*1/4"	1
88	30101049	CAP		1
89	30101050	NUT	15/16"24UNF*2	2
93	30105054A	WRENCH		2
94	30105055	ARBOR		6
95	30105056	HEX NUT		6
96	S0313525	SPRING PIN	3.5*25	10
97	30105057	SANDING SPINDLE	4"	1
98	30105058	WASHER		2
99	30105059	NUT	3/4"	6

Index	Part Number	Descriptions	Specifications	QTY
100	Local Purchase	SANDING SLEEVE	4" x 9"	1
101	30105061	SANDING SPINDLE	3"	1
102	Local Purchase	SANDING SLEEVE	3" x 9"	1
103	30105063	WASHER		2
104	30105064	SANDING SPINDLE	2"	1
105	Local Purchase	SANDING SLEEVE	2" X 9"	1
106	30105066	WASHER		2
107	30105067	SANDING SPINDLE	1-1/2"	1
108	Local Purchase	SANDING SLEEVE	1-1/2" X 9"	1
109	30105069	WASHER		2
110	30105070	SPINDLE	1"	1
111	Local Purchase	SANDING SLEEVE	1" X 9"	1
112	30105072	WASHER		2
113	Local Purchase	SANDING SLEEVE	3/4" X 9"	1
114	30105074	ARBOR		1
115	30105075	HEX NUT		1
118	Local Purchase	SANDING SLEEVE	5/8" x 6"	1
119	30105077	ARBOR		1
120	30105078	HEX NUT		1
122	Local Purchase	SANDING SLEEVE	1/2" x 6"	1
124	30105080	ARBOR		1
125	30105081	HEX NUT		1
127	Local Purchase	SANDING SLEEVE	3/8" x 6"	1
128	S0050305	SET SCREW		4
129	30105083	HEX NUT		1
130	Local Purchase	SANDING SLEEVE	1/4" x 5"	1
133	30105085	ARBOR		1
134	30101004	OIL PLUG		1
135	30105087	BRASS BUSHING BRACKET		1
136	30105088	SHAFT BRASS BUSHING		4
137	30101005	KNOB		1
138	S0010510	SCREW	5/16"*18UNC*5/8"	4
139	30101030A	BRACKET BASE		2
140	S0210500C	WASHER	5/16"x18x2t	4
142	10105052N	SWITCH BOX		1
143	S0030324	SCREW	3/16"*24*1 1/2"	7
143A	S0110300	NUT	3/16"-24UNC	3
144	30101002J-1	STAND ACCESS PANEL		1
145	30101002JM	STAND		1

Index	Part Number	Descriptions	Specifications	QTY
146	30101003A	MOTOR BRACKET		1
147	M000000	MOTOR	2HP 1Ph	1
148	S1006P1	STRAIN RELIEF BUSHING		1
149	S0230506	SPRING WASHER	5/16"	8
150	S0010501	HEX SCREW	5/16"*18UNC*1"	12
151	30102008A	COUPLING HEAD		1
152	30101009A	GEAR BOX		1
153	S0050404	SET SCREW	1/4"*20UNC*1/4"	2
154	30101013A	GEAR BOX COVER		1
155	W0000003P	SWITCH		1
157	S0210600	WASHER	3/8"	4
158	30101033A	TABLE TRUNNION		2
159	30101031J	LOCKING KNOB		2
160	30101034A	DUST COLLECTION PORT	4" O.D.	1
161	S0020501	HEX SCREW	5/16"x18UNCx1"	2
162	S0110500	NUT	5/16"- 18UNC*12*6	2
163	30101036A	WORK TABLE		1
164	30101047A	TABLE SCALE		1
165	30105051A	TABLE INSERT (MEDIUM)		1
166	30105052A	TABLE INSERT (SMALL)		1
167	30105053A	TABLE INSERT (LARGE)		1
169	30101027A	FIXED ROD		1
170	S0110600	NUT	3/8"-16UNC	1
171	10401029	RUBBER FEET		4
172	S0030512	SCREW	5/16"*18UNC*3/4"	4
173	S0110500	NUT	5/16"- 18UNC*12*6	4

#### Replacement Spindle Assembly

Index	Part Number	Descriptions	Specifications	QTY
NS	3010500GA	COMPLETE ASSEMBLY w/ABRASIVE SLEEVE	1/4" x 5"	1
NS	3010500GB	COMPLETE ASSEMBLY w/ABRASIVE SLEEVE	3/8" x 6"	1
NS	3010500GC	COMPLETE ASSEMBLY w/ABRASIVE SLEEVE	1/2" x 6"	1
NS	3010500GD	COMPLETE ASSEMBLY w/ABRASIVE SLEEVE	5/8" x 6"	1
NS	3010500GE	COMPLETE ASSEMBLY w/ABRASIVE SLEEVE	3/4" X 9"	1
NS	3010500GF	COMPLETE ASSEMBLY w/ABRASIVE SLEEVE	1" X 9"	1
NS	3010500GG	COMPLETE ASSEMBLY w/ABRASIVE SLEEVE	1-1/2" X 9"	1
NS	3010500GH	COMPLETE ASSEMBLY w/ABRASIVE SLEEVE	2" X 9"	1
NS	3010500GI	COMPLETE ASSEMBLY w/ABRASIVE SLEEVE	3" x 9"	1
NS	3010500GJ	COMPLETE ASSEMBLY w/ABRASIVE SLEEVE	4" x 9"	1

\*NS: Item not shown in the exploded view diagram.







# Warranty and Service

Oliver Machinery makes every effort to assure that its equipment meets the highest possible standards of quality and durability. All products sold by Oliver Machinery are warranted to the original customer to be free from defects for a period of two (2) years on all parts excluding electronics and motors which are warranted for one (1) year from the date of shipment. Oliver Machinery's obligation under this warranty shall be exclusively limited to repairing or replacing products or parts or components, at its sole option, determined by Oliver Machinery to be defective. Oliver Machinery shall not be required to provide other form of indemnity or compensation including but not limited to compensatory damages.

This warranty does not apply to defects due to direct or indirect misuse, abuse, negligence, accidents, unauthorized repairs, alternation outside our facilities, lack of maintenance, acts of nature, or items that would normally be consumed or require replacement due to normal wear and tear.

## **OTHER TERMS**

To obtain and exercise the warranty right, please call 800-559-5065 or fill out the warranty request form online at [www.olivermachinery.net](http://www.olivermachinery.net).

Warranty parts are shipped via Parcel or Ground. Additional charges will occur and charge to customers if express shipping is required.

## **DISCLAIMER**

Under no circumstances shall Oliver Machinery be liable for death, personal or property injury, or damages arising from the use of its products.

Oliver Machinery reserves the right to make changes without prior notice to its products to improve function or performance or design.

## **FOR MORE INFORMATION**

If you need assistance or have questions beyond what is covered in the scope of this warranty information, please call 800-559-5065 or email us at [info@olivermachinery.net](mailto:info@olivermachinery.net).



Oliver Machinery is always adding new Industrial Woodworking products to the line.

For complete, up-to-date product information, visit us online at:

[WWW.OLIVERMACHINERY.NET](http://WWW.OLIVERMACHINERY.NET)

or call toll free 1-800-559-5065

**\*\* SAVE THIS MANUAL FOR FUTURE REFERENCES. \*\***