

Jointer

Model 4275C

Owner's Manual

For Models Manufactured Since 02/2021



Oliver Machinery
1-800-559-5065
921 Thomas Ave SW,
Renton, WA 98057

info@olivermachinery.net
WWW.OLIVERMACHINERY.NET

Stock Number: 4275C.101.4S
4275C.102.4S
Manual Version: 1.0.0



READ AND UNDERSTAND ALL INSTRUCTIONS IN THIS MANUAL BEFORE ATTEMPTING TO ASSEMBLE OR OPERATE THE MACHINE.

FOLLOW THE INSTRUCTIONS AND THINK SAFETY!

THE OWNER OF THIS MACHINE IS SOLELY RESPONSIBLE FOR THE SAFETY OF ANYONE USING THIS MACHINE. SUCH RESPONSIBILITY INCLUDES BUT NOT LIMITED TO:

- **PROPER ASSEMBLY, OPERATION, INSPECTION, MAINTENANCE, AND RELOCATION OF THE MACHINE.**
- **PROPER TRAINING FOR THE OPERATORS AND ENSURES THIS MANUAL IS AVAILABLE AT ALL TIMES.**
- **USAGE AUTHORIZATION.**
- **USAGE OF SAFETY AND PROTECTION DEVICES.**

OLIVER MACHINERY DISCLAIMS ANY LIABILITY FOR MACHINES THAT HAVE BEEN ALTERED OR ABUSED. OLIVER MACHINERY RESERVES THE RIGHT TO EFFECT AT ANY TIME, WITHOUT PRIOR NOTICE, THOSE ALTERATIONS TO PARTS, FITTINGS, AND ACCESSORY EQUIPMENT WHICH THEY MAY DEEM NECESSARY FOR ANY REASON WHATSOEVER.

**** SAVE THIS MANUAL FOR FUTURE REFERENCES. ****

PROP 65 NOTICE

WARNING: Drilling, sawing, sanding, or machining wood products can expose you to wood dust, and/or other chemicals that are known to the State of California to cause cancer, birth defects, or other reproductive harm.

Some examples of these chemicals are:

- Lead from lead-based paints.
- Crystalline silica from bricks, cement, and other masonry products.
- Arsenic and chromium from chemically treated lumber.

Avoid inhaling wood dust and other harmful chemicals. Use a dust mask and/or other safety devices for personal protection.

For more information go to <http://www.P65Warnings.ca.gov/wood>

Table of Contents

Introduction	6	Test Run	29
Specifications	7	Operation	30
Identification	10	Preparation	30
Safety	12	Inspect Wood Grain	31
General Safety Guidelines	12	Squaring Stock	31
Safety Guidelines Specific to Jointer	13	Surface Planing	32
Electricals	15	Edge Jointing	34
Minimum Circuit Size Required for Model 4275C Jointer	15	Beveling	34
Grounding	15	Rabbet Cutting	35
Electrical Wiring	15	Common Cutting Problems	36
Setup	17	Snipe.....	36
Shop Preparation	17	Chipping	36
Space Requirement	17	Fuzzy Grain	36
Load Limits	17	Accessories	37
Electricals	17	460V Conversion Kit	37
Lighting.....	17	Cutter Inserts	37
Safety Labels	17	Touchup Paint	37
Dust Collection	17	Power Feeder	38
Receiving	18	Maintenance	39
Cleaning	21	Maintenance Schedule	39
Assembly	22	Inspect / Adjust Jointer Tables	40
Leveling Machine	24	Inspect Outfeed Table Height	40
Dust Collection	24	Adjust Outfeed Table Height	40
Wiring and Grounding	25	Inspect Outfeed Table Parallelism	41
Wiring Instructions.....	25	Inspect Infeed Table.....	41
Adjust Table Parallelism/Coplanarity	42	Adjust Table Parallelism/Coplanarity	42
Infeed Table Adjustments	44	Infeed Table Adjustments	44
Infeed Table Positive Stops Adjustments	44	Infeed Table Positive Stops Adjustments	44
Controls and Components	26	Rotate / Replace Cutter Inserts	45
Control Panel	26	Adjust Fence Positive Stops	46
Infeed Table Height Adjustment	26	Adjust Belt Tension	47
Infeed Table Depth Stop Knob	27	Align Belt Pulleys	48
Outfeed Table Height Adjustment	27	Troubleshooting	49
Fence	27	Mechanical / Electrical Issues	49
Digital Readout (DRO)	28	Operation / Quality-Related Issues	50
DRO Calibration	28		

Wiring Diagram52
 For Stock # 4275C.101.4S (230V, 1Ph).....52
 For Stock # 4275C.102.4S (230/460V, 3Ph) 53
Parts List54
Maintenance Record.....66

Notes..... 67
Warranty and Service..... 68
Appendix 69
 US Standard – Metric Conversion Chart.....69

Introduction

Thank you for choosing Oliver! This manual contains important information on how to safely set up, operate, and maintain this machine. Please take the time to read through this manual, and make sure you understand all instructions.

While this manual may provide tips on optimizing the result of your workpiece, the manual is not intended as a substitute for formal woodworking training. If you need to know how to safely complete a woodworking task, please consult knowledgeable and qualified sources before proceeding further.

We made every effort to keep this manual up-to-date. Instructions, specifications, drawings, and photographs in this manual should match the machine delivered. If you find any differences, or anything that seems confusing in this manual, or some instructions are not available, please check our website for an updated version:

WWW.OLIVERMACHINERY.NET/MANUALS

Alternatively, you can contact our technical support for help:

1-800-559-5065

Before calling, please note down the manufacture date and the serial number of the machine. You can find the information on a nameplate located on the back of the machine, right above the electrical junction box. This information is needed to provide proper technical support, and to determine if an updated manual is available for your machine.

Please let us know how well this manual serves you. If you have any suggestions, please call the number above or email us at:

info@olivermachinery.net

We love to hear from our customers and make improvements.

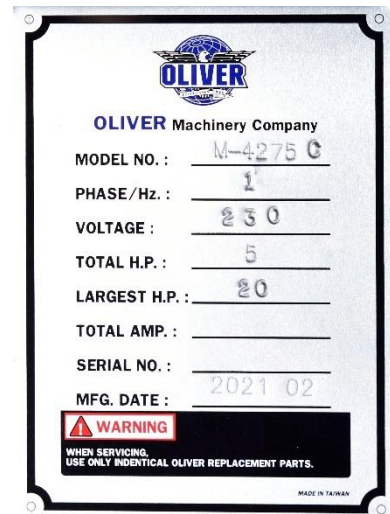

Specifications

Quick View

Model	4275C Jointer	
Stock Number	4275C.101.4S	4275C.102.4S
Motor	Baldor TEFC Induction Motor 5HP, 230V, 1Ph	Baldor TEFC Induction Motor 7.5HP, 230/460V, 3Ph
Jointer Size	16"	
Max. Depth of Cut (Jointing)	1/8"	
Max. Depth of Cut (Rabbeting)	3/4"	
Bevel Joining	90° -135°	
Dimensions	100"(L) x 45-1/2(W) x 50"(H)	
Footprint	52-1/2"(L) x 24-1/2"(W)	
Fully Assembled Weight	1109 lbs.	
Warranty	1 Year (Motor and electronics) 2 Years (All other parts)	

Product Dimensions

<i>Jointer Fully Assembled</i>	100"(L) x 45-1/2"(W) x 50"(H)
<i>Footprint</i>	52-1/2" (L) x 24-1/2"(W)
<i>Fully Assembled Weight</i>	1109 lbs.

Shipment Info

Type	Wood crate with pallet base
Content	Jointer with included accessories
Dimensions	103" (L) x 34(W) x 52"(H)
Weight	1272 lbs.
Approximate Setup Time	60 minutes
Must Ship Upright	YES
Stackable	NO

Electricals

Stock Number	4275C.101.4S	4275C.102.4S
Power Requirement	230V, 1Ph, 60Hz	230/460V, 3Ph, 60Hz
Full Load Current Rating	19.5A	16.8/8.4A
Recommended circuit size	30A	25A
Power Switch Type	Magnetic switch with overload protection.	
Connection Type	Cord and plug not included. Electrical hookups required.	
Overload Protection	Equipped	

Motor

Stock Number	4275C.101.4S	4275C.102.4S
Motor Type	Baldor TEFC Induction Motor	
Horsepower	5HP	7.5HP
Speed	3600 RPM	3600 RPM
Efficiency	83%	89.5%
Power Factor	99	93
Power Transfer Mechanism	Poly V-belt and pulleys	
Bearing type	Permanently sealed ball bearing	

Jointer Capacity and Performance

Maximum Stock Width	16"
Maximum Depth of Cut for Jointing	1/8"
Maximum Depth of Cut for Rabbeting	3/4"
Minimum Width of Cut for Rabbeting	1-1/4"
Minimum Stock Thickness	1/2"
Minimum Stock Length	12"

Fence

Dimensions	47-1/2" (L) x 5-3/8" (H)
Fence Travel	14-3/4"
Fence Stops	90° and 135°
Material	Precision ground cast iron

Cutterhead

Cutterhead Type	Helical
Cutterhead Diameter	4"
Cutterhead Speed	5500 RPM
Number of Cutter Inserts	76
Number of Rows of Cutter Inserts	4
Cutter Insert Type	Four-sided, indexable carbide
Cutter Insert Diameters	15mm x 15mm x 2.5mm
Cutter Blade Angle	30 degree
Cutter Insert Screw Tensioning Torque	52-60 lb-in

Table

Table Dimensions	100" (L) x 16" (W)
Table Height Above Ground	34-1/2"
Table Lifting / Adjustment Mechanism	Parallelogram
Material	Precision ground cast iron

Measurements

Measurement Unit	Inch/mm
Measurement Device	Wixey digital readout
Digital Readout Resolution	1/32" / 0.005" / 0.05mm
Digital Readout Accuracy	±1/500" / 0.002" / 0.05mm
Backup Measurement Device	Cutting depth scale with a pointer.

Safety

Stock Number	4275C.101.4S	4275C.102.4S
Number of Dust Ports	1	
Dust Port Size	6"	
Minimum CFM Required	700 CFM	
Sound Rating @ 2' distance	90-95 dB	92-96 dB

Others

Serial Number Location	On the back of the machine.
Spare Parts Included	Ten cutter inserts and compatible Torx screws.
Certification	CSA 175370
Country of Origin	Taiwan

Identification

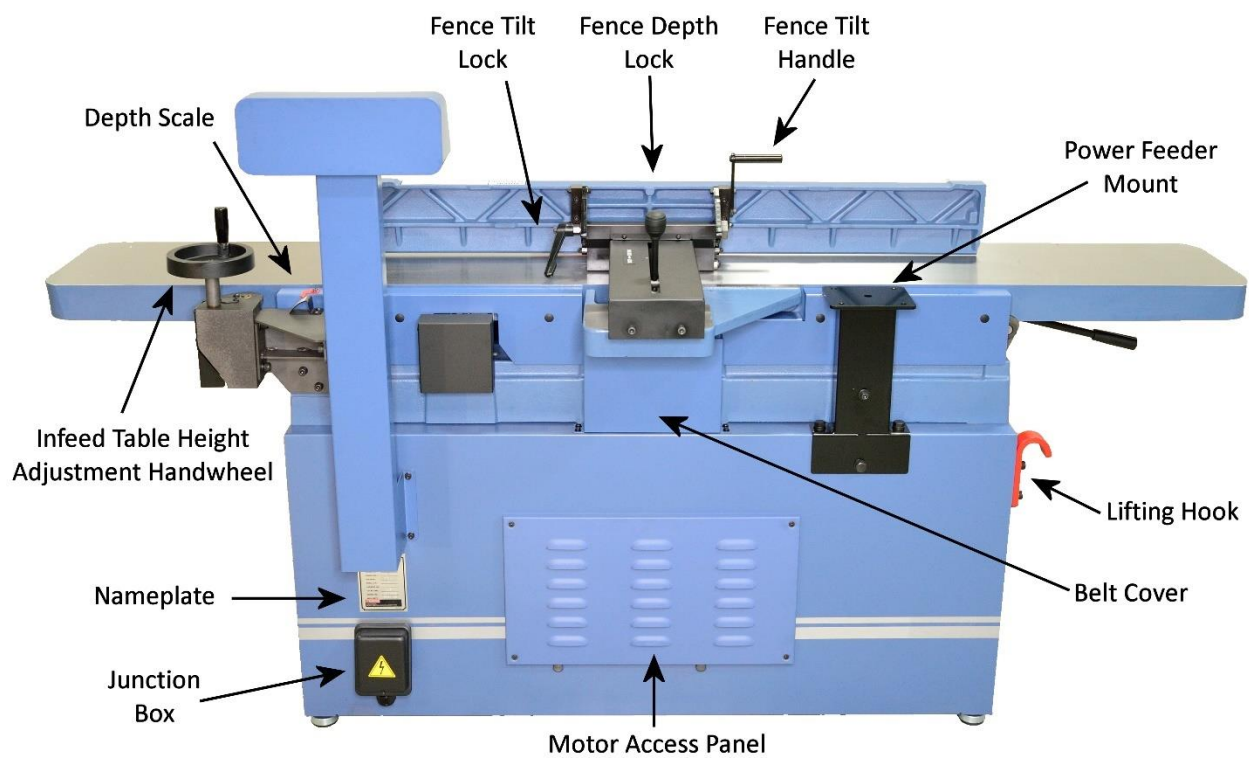
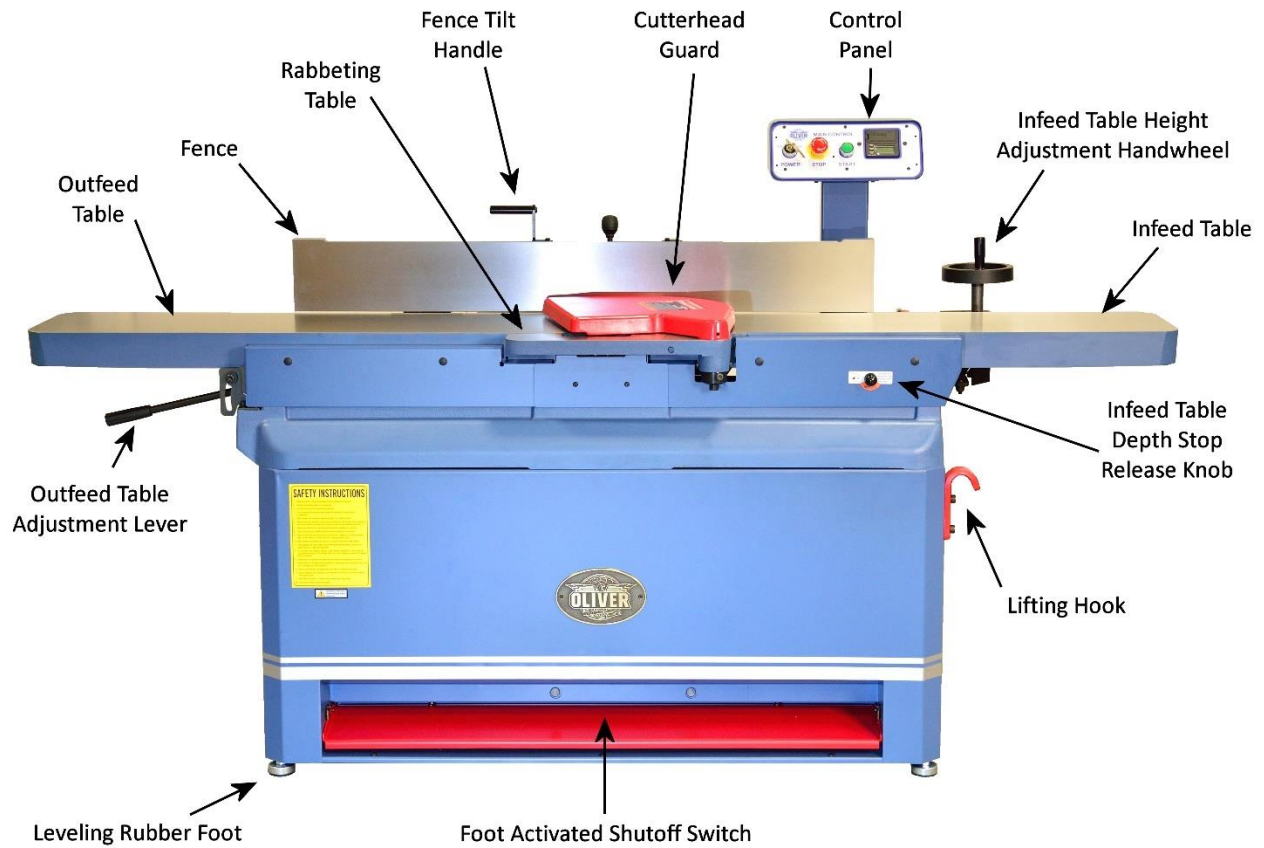

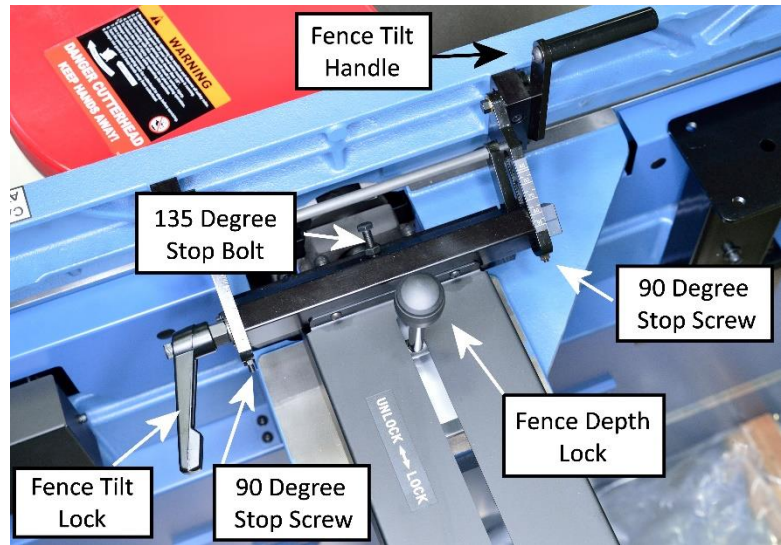

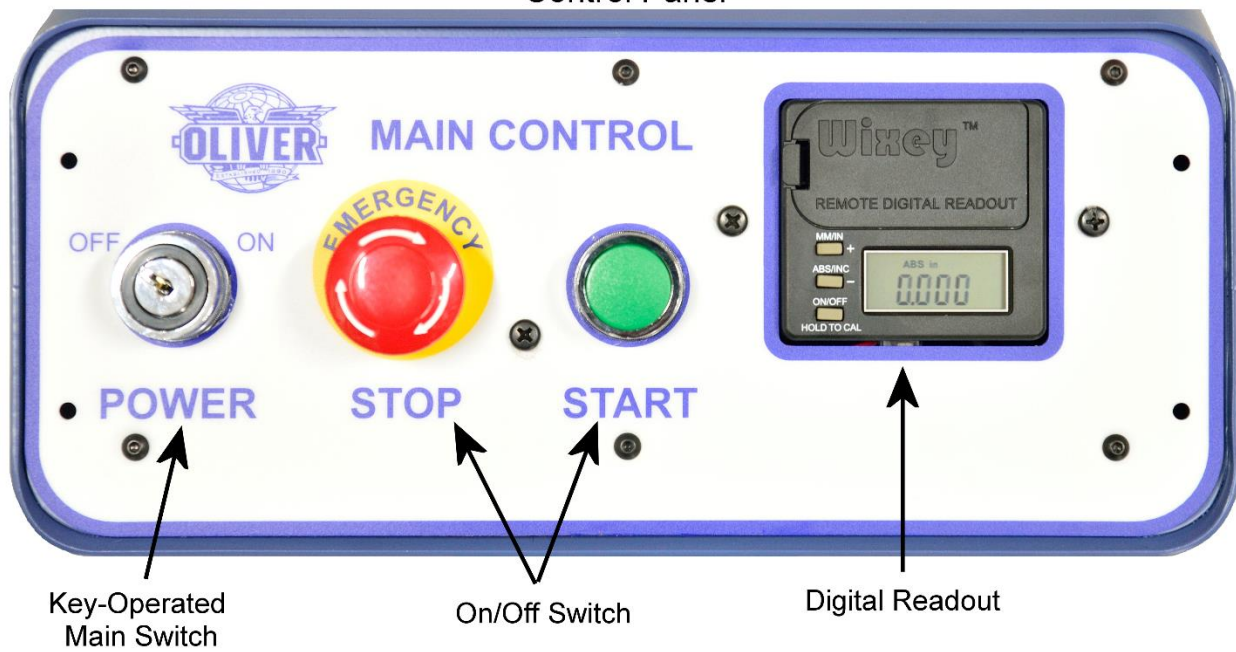

Control Panel



Safety

Oliver Machinery has made every attempt to provide a safe, reliable, easy-to-use piece of machinery. Safety, however, is ultimately depending on the individual machine operator. **Before operating this machine, please become familiar with the following safety labels and guidelines.**

 DANGER	This indicates an imminently hazardous situation which, if not avoided, WILL cause death or serious injury.
 WARNING	This means if the warning is not taken seriously, it CAN cause death or serious injury.
 CAUTION	This means if the precaution is not taken, it MAY cause minor or moderate injury.
IMPORTANT	This is a tip for properly operating the machine to avoid machine damage.

General Safety Guidelines

1. **FAMILIARIZE** yourself with all safety instructions found in this manual. Know the limitations and hazards associated with this machine. Do not operate/service this machine until you are properly trained.
2. **ELECTRICAL GROUNDING**, when done properly, reduce the risk of electrocution, shocks, and fire. Make certain that the machine frame is electrically grounded and that a ground lead is included in the incoming electrical service. In cases where a cord and a plug are used, make certain that the grounding plug connects to a suitable ground. Follow the grounding procedure indicated in the electrical code of your area.
3. **DISCONNECT** the machine from power before performing any service, maintenance, or adjustments. A machine under repair should be RED TAGGED to show it should not be used until the repair is complete.
4. **EYE PROTECTION**: Always wear an approved safety face shield, goggles, or glasses that complies with ANSI Z87.1 and CSA Z94.3 standards. Common eyeglasses are not safety glasses, and may not provide adequate protection.
5. **EAR PROTECTION**: Use hearing protective devices where the noise exceeds the level of exposure allowed in Section 1910.95 of the OSHA Regulations. When in doubt, use it.
6. **OTHER PERSONAL PROTECTION**: Before the operation, remove tie, rings, watch, and other jewelry. Roll up sleeves above elbows. Remove all loose outer clothing and confine long hair. Protective footwear should be used. Do not wear gloves when operating woodworking machinery. However, it is recommended to wear protective gloves when servicing machines.
7. **GUARDS**: Keep machine guards in place for all applicable operations. If any guards are removed for maintenance, DO NOT OPERATE the machine until all guards are reinstalled. Check clearance between the guards and the cutter before starting the machine.
8. **WORKPLACE SAFETY**: Keep the floor around the machine clean. Scrap material, sawdust, oil, and other liquids increase the risk of tripping or slipping. Be sure to clean up the table before starting the machine. Make certain the work area is well lighted and that a proper exhaust system is used to

minimize dust. Use anti-skid floor strips on the floor area where the operator normally stands and mark off the machine work area. Provide adequate workspace around the machine.

9. **ACCESS CONTROL** should be enforced so only trained personnel can access the work area and operate the machine. When possible, lock the machine when it is not in use.
10. **STAY ALERT** at all times. Do not operate this machine while under the influence of drugs/alcohol, or when not feeling well.
11. **NEVER STAND ON MACHINE.** This prevents injuries from tipping related accidents and accidental contacts with cutters.
12. **REPLACEMENT PARTS:** Use only genuine Oliver Machinery replacement parts and accessories recommended for this machine. Generic parts made by other manufacturers may create a safety hazard and WILL void the factory warranty and other guarantees.
13. **PROPER USE:** Do not use this machine for anything other than its intended use. If used for other purposes, Oliver Machinery disclaims any real or implied warranty and holds itself harmless for any injury or damage which may result from that use.

Safety Guidelines Specific to Jointer

Before Work Begins:

1. **USE ONLY NATURAL, SOLID WOOD.** Do not joint any material such as plywood, MDF, OSB, laminate, or anything that can disintegrate during operation. Do not joint treated lumber or anything that contains harmful chemicals, as this will spread wood dust that contains such harmful chemicals. Do not attempt to joint any workpiece with loose knots or with any other foreign materials.
2. **CHECK CUTTER INSERTS:** Make sure cutter inserts are sharp, clean, and free from damages. Forcing dull/damaged cutter inserts to work invites accidents and impacts finish quality. Use the recommended amount of torque to securely fasten all inserts onto the cutterhead.
3. **SERVICING CUTTER INSERTS:** Wear heavy-duty leather gloves to protect your hands when installing new cutter inserts or rotating the existing ones. Ensure the cutterhead is thoroughly cleaned before installing the insert. Debris between the cutter insert and the platform can create uneven pressure, causing the insert to break, and body injuries may occur.
4. **CHECK CUTTERHEAD GUARD:** Make sure the cutterhead guard is installed and is properly tensioned. The cutterhead guard should spring back and push against the fence after it is rotated away and released.
5. **CHECK OUTFEED TABLE HEIGHT AND ALIGNMENT** to avoid a workpiece getting stuck while feeding.
6. **CHECK DEPTH OF CUT SETTING.** The maximum depth of cut for each pass is 1/8".
7. **SUPPORT LONG WORKPIECE** with auxiliary stock feeding rollers/tables. This reduces the risk of injuries and improves the quality of the finish.

When Jointing:

1. **DUST COLLECTION SYSTEM** is required for this jointer. Please make sure the system is on and provide enough suction before starting the jointer.
2. **KICKBACK** happens when a workpiece is ejected at high speed during operation. Kickback projectiles can cause serious injuries or even death. Sudden movements of the workpiece from kickback can also cause hands or other body parts to get pulled into the cutterhead. The operator should be cautious at all times about possible kickback.
3. **PROPER STOCK FEEDING** reduces the chance of kickback. NEVER start the machine with anything engaging the cutterhead. NEVER start feeding until the jointer has reached its full speed. Use the right amount of downward pressure and forward force for feeding.
4. **INSPECT WORKPIECE.** Ensure the workpiece is free from nails, loose knots, and other foreign material. Use a metal detector to scan for metal objects as appropriate.
5. **NEVER** joint material shorter than 12", thinner than 1/2", or narrower than 2". This reduces the risk of accidental contact with the cutterhead.
6. **NEVER** rabbet material with width or thickness less than 3/4", or shorter than 12".
7. **FOLLOW THE 3-INCH RULE.** Always use push blocks when jointing materials less than 3" in thickness or width. Keep your hands at least three inches away from the cutterhead at all times when the machine is running.
8. **CUPPED WORKPIECE** should be jointed with the cupped side facing down. This prevents the workpiece from rocking when feeding through the jointer.
9. **PAY ATTENTION TO THE GRAIN DIRECTION.** Always cut WITH the grain whenever possible. Jointing against or across the grain, or jointing the end grain increases the chance of tear-out and kickback.

After Operation

1. **STOP THE MACHINE** if the operator leaves the machine for any reason.
2. **WAIT** until the machine comes to a complete stop.
3. **CLEAN UP** and **LOCK POWER SWITCH** before departure.

Electricals



WARNING All electrical work must be done by a qualified electrician and must meet the electrical code in your area.

Minimum Circuit Size Required for Model 4275C Jointer

Stock Number	Minimum Circuit Size Required
4275C.101.4S	30A
4275C.102.4S	25A

Please ensure the electrical circuit for this machine meets the minimum circuit size requirement. The minimum circuit size requirement applies to a dedicated circuit that provides power to one 4275C Jointer. If more machines are sharing the same circuit, consult a qualified electrician to ensure the designated circuit is properly sized for safe operation.

If a circuit is available, but not meeting the minimum circuit size requirement listed above, a new circuit must be installed for this machine.

Grounding



WARNING Improper grounding can cause electric shock, fire, and equipment damage.

Proper grounding reduces the risk to the operator in the event of electrical malfunction or breakdown. This machine must be connected to the grounding conductor when available, and all grounding connections must meet or exceed the electrical code requirements in your area. Furthermore, all grounds must be verified and must meet or exceed the electrical requirement of the machine. If grounding is not available, consider the use of a GFCI protection device as an alternative, if this complies with the electric code in your area.

Electrical Wiring

This machine is not pre-wired with a cord and a plug. If you plan to connect the machine directly to the electrical panel (“Hardwiring”). Please ensure there is a readily accessible electrical disconnect near the machine. Refer to the section “Wiring Diagram” for wiring your machine to a power source.

If you choose to connect this machine with a plug and a cord, please use a UL/CSA listed plug. If you need an extension cord to connect to the power outlet, select a durable cord type with a high-temperature rating (90C° or above). Both plug and power cord must be sized to meet the amperage requirement of your machine.



Minimum cord size (AWG) required based on amperage draw and length of the cord:

<i>Amps</i>	Power Cord Length				
	25 feet	50 feet	75 feet	100 feet	> 100 feet
< 5	16	14	14	14	NR
5 to 8	14	14	14	12	
8 to 12	14	14	12	10	
12 to 15	12	12	10	10	
15 to 20	10	10	10	NR	
21 to 30	10	NR	NR	NR	

*NR: Not Recommended

 WARNING	<p>Use properly sized wires that meet or exceed the power requirement of your machine. Using undersized wires may cause overheating and increase the risk of fire and machine damage.</p>
---	--

 WARNING	<p>Improper copper-aluminum wire connection is a fire hazard. If the power circuit available uses aluminum wires, use certified CU/AL wire connectors.</p>
---	---

Setup

Shop Preparation

Space Requirement

The dimensions of this machine are 100"(L) x 45-1/2"(W). You will need additional spaces for manipulating your workpiece, electrical connection, and dust collection.

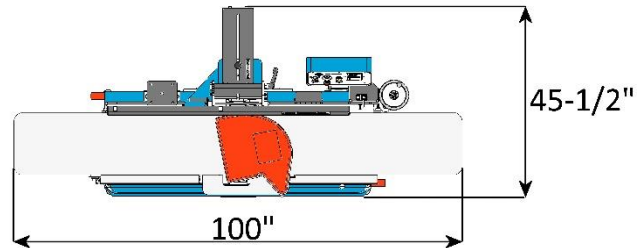

Load Limits

This machine has a shipping weight of 1272 lbs., and a net weight of 1109 lbs. Please ensure all lifting tools and building structures have adequate load capacity, for transporting and supporting the total weight of this machine, the operator, and related items.

Electricals

Ensure a properly sized circuit and an electrical terminal are available nearby the machine. If the machine is to be hardwired, there must be a readily accessible power disconnect nearby, so that the machine can be disconnected from the power source for servicing and adjustments. If the machine is to be connected with a cord and a plug, please ensure a matching outlet is installed nearby the machine.

Please refer to the previous chapter “Electricals” on page 15 for details regarding electrical requirements.

Lighting

Adequate lighting is needed for operating this machine. Overhead, non-glare lighting should be installed.

Safety Labels

If this machine introduces a new safety hazard to your workplace, display proper warning signs in a highly visible location(s).

Dust Collection

Wood dust created by this jointer is a health hazard. Connect a dust collection system to this machine. Check air suction regularly to ensure the pipes are not jammed.

Dust masks should be available for using the jointer.



Use a dust collection system that is rated above 700 CFM. Doing so improves air quality in the workplace, and prevents the machine from jamming.

Piping of the dust collection system introduces additional air resistance and decreases the effective CFM measured at the dust ports. Ensure there is significant suction at the dust port, so dust and debris can be effectively removed from the machine.

Receiving

Your shipment should come with one wood crate. Upon receiving your shipment, check for any significant damages before signing the delivery confirmation.

IMPORTANT

If items are damaged, please call us immediately at **1-800-559-5065**

Moving Machine into the Shop

Your machine will be delivered by freight service, and it will be left outside of your workshop by default. On the day of delivery, please be sure help is available to move the machine to its final location.



4275C Jointer has a gross weight of 1272 lbs. and a net weight of 1109 lbs.

Safe moving techniques and proper lifting equipment are required, or serious personal injury may occur.



Your shipment may be secured by the straps. Do not lift your shipment by the strap. They are not designed to hold the total weight of your shipment. They may snap without warning and cause serious injury and machine damage.

Always wear safety goggles and gloves when removing straps, as they may spring back violently when released and cause injury.

Unboxing

The crate contains a jointer that is mostly assembled. It also contains two paper boxes with loose parts and accessories. Everything is covered by a plastic bag.



Inventory

Carefully unwrap the packaging and inventory the items received:

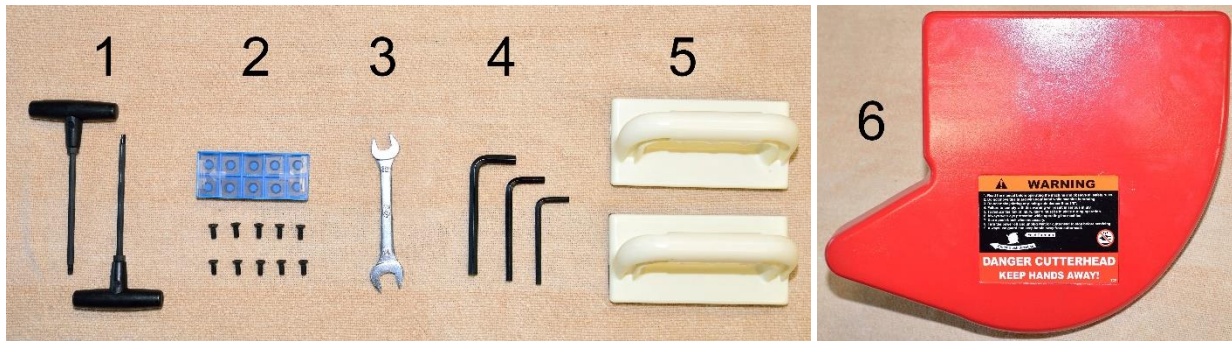

Item	Description	Quantity
1	T-Handle torx drivers (T-25)	2
2	Spare Cutter Inserts and Torx Screws	10 each
3	12/14 mm Combination Wrench	1
4	Metric hex wrench set (5,6,8 mm)	1 each
5	Push blocks	2
6	Cutterhead guard	1

NOTICE: If you cannot find an item in the list above, please check if it is still attached to the packaging or inside the cabinet. Occasionally the item may have been pre-installed in the factory. See section “Parts List” to check if a component is included or installed.

NOTICE: This machine comes with various standard-sized, non-proprietary parts. If any of these parts are missing, we are happy to deliver them to you. To have the machine up and running as soon as possible, you can also find these parts at your local hardware store.

Additional Items Recommended for Machine Setup

Item	Purpose
Safety Glasses	Protection
Disposable Gloves	Protection
Paper Towel / Rags	Cleaning
Rust Inhibitor	Cast iron rust protection.
Straight edge	Check alignments.
Metric Combination Wrench Set	Assembly and Maintenance
Metric Hex Wrench Set	Assembly and Maintenance
Torque Wrench	Cutter inserts installation and for checking Torx screw tension (52-60 lb-in).
T25 Star Bit Socket	Cutter inserts installation.
Ring Terminal Connector and Crimping Tool	Connecting machine to power. IMPORTANT: Always follow local electrical code for electrical work.

Removing Machine from Crate

When all items are ready for machine setup, attach the lifting sling to the lifting hooks located at the two corners of the cabinet. Gently lift the machine from the pallet and move it to its final location.

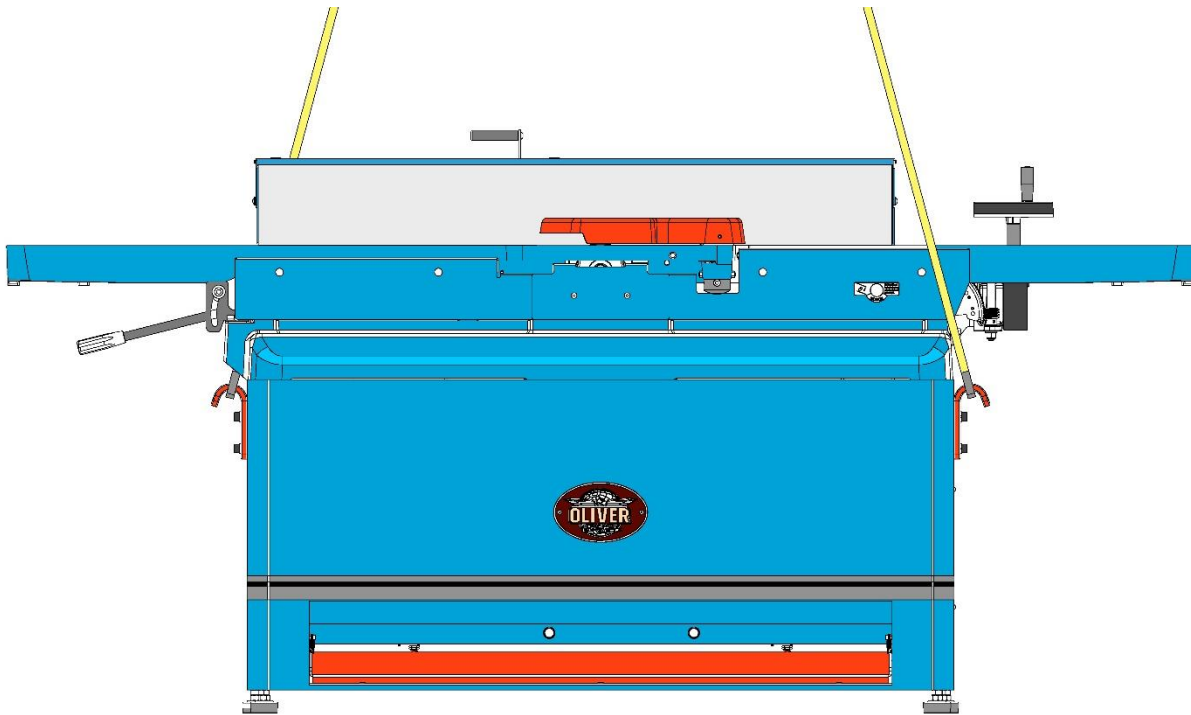

WARNING

4275C Jointer has a net weight of 1109 lbs. All lifting devices must be capable to handle the load, or serious personal injury and machine damage may occur.

IMPORTANT

Use the lifting hooks for lifting the jointer. Do not lift the machine by the tables as it may alter the alignment of the tables.

Cleaning

To prevent rusting, the unpainted cast iron surfaces of this jointer are covered with machine oil and plastic film.

Loosen the fence tilt lock [1] and use the handle [2] to raise the fence above the table. Lock the fence in place. Release the fence position lock [3], and move the fence all the way back. Remove the packaging and wipe off machine oil with paper towels or rags.

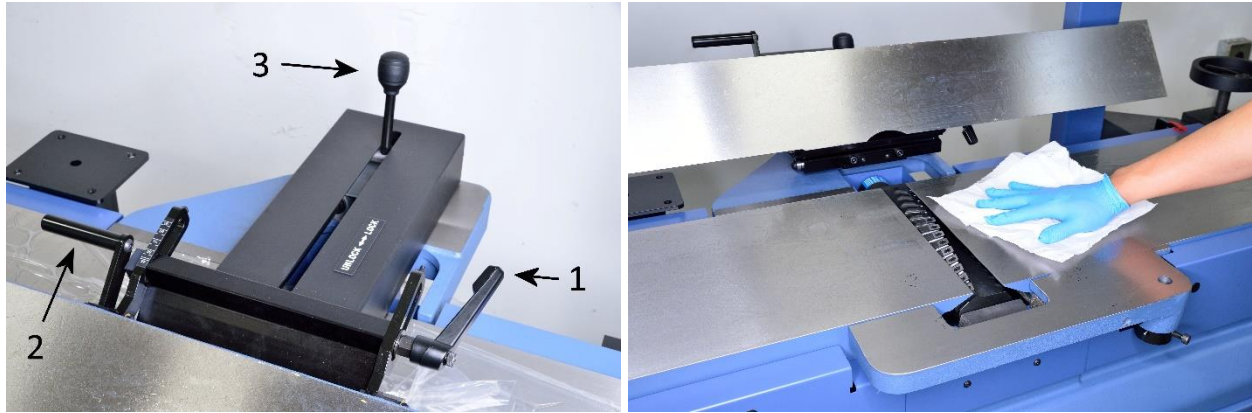

After the initial cleaning, routinely coat the unpainted cast iron surface with rust preventive such as Boeshield® T-9 or paste wax. Do not use rust preventives that contain silicone, which is known to interfere with certain finishes and glues.

Assembly

This jointer is mostly assembled in the factory. There are a few more steps to complete before the machine is ready for a test run:

1. Setup control panel.
2. Install battery for digital readout.
3. Inspect / Adjust Jointer Tables (optional).
4. Install cutterhead guard.
5. Connect jointer to a dust collection system.
6. Connect jointer to a power source.

The approximate time for cleaning and assembly is approximately 60 minutes.

Inspect / Adjust Jointer Tables

The jointer tables are calibrated in the factory and should not require adjustments initially. Refer to section "Inspect / Adjust Jointer Tables" on page 40 to perform these steps if needed.

Setup Control Panel

1. To prevent damages, the control panel is lowered when it is shipped from the factory. Please follow the instructions to set up the control panel:



2. Remove all six cap screws from the control panel post.

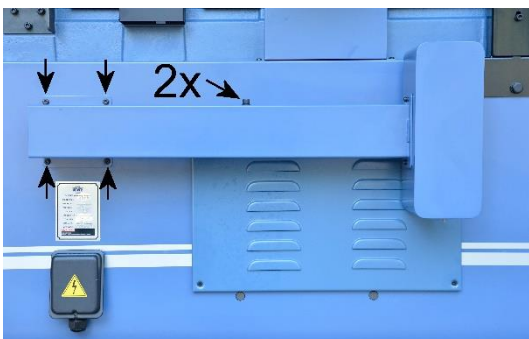

3. Raise the control panel to its operational position, then remount it back to the cabinet.



4. Attach the last two cap screws through the table adjustment handwheel bracket.

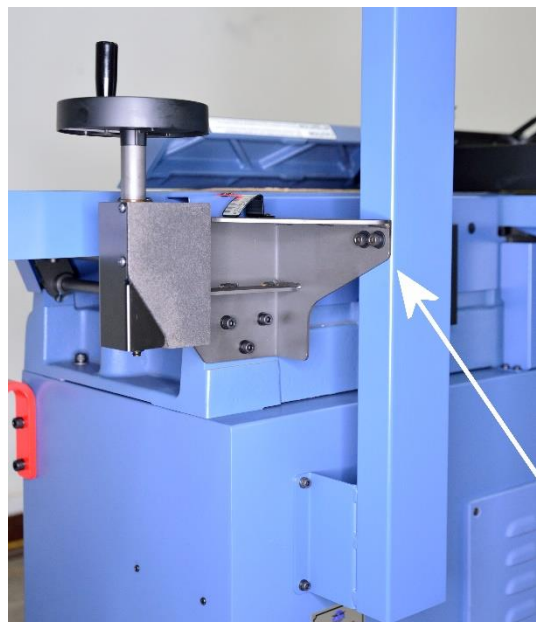

Install Batteries for Digital Readout

Locate the digital readout on the control panel. Remove the battery cover and install two AA-sized batteries.



Install Cutterhead Guard

1. Loosen the fence tilt lock and use the handle to raise the fence above the table. Lock the fence in place. Release the fence position lock, and move the fence all the way back.

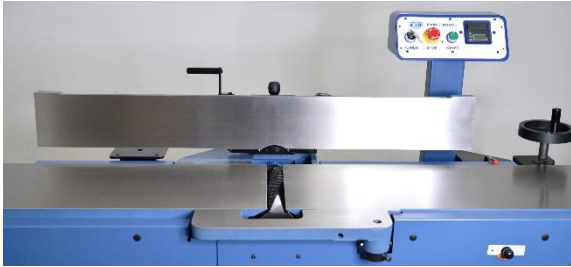

2. Insert cutterhead guard shaft into the hole on the rabbeting table.



3. The guard must be installed as low as possible, such that it can swing freely without scratching the table.



4. There is a spring-loaded knob at the bottom of the rabbeting table. It has a cap screw that grabs the cutterhead guard shaft and keeps the guard pushing against the fence.

Rotate the knob counterclockwise until you can feel the tension from the spring, then rotate it for another 1/3 turn. Hold the knob in position and tighten the cap screw.



NOTICE: There are four screw holes on the knob. If the cap screw gets in the way while the knob rotates, relocate the screw so the cutterhead guard can rotate freely.

5. Positioned the fence at the rear edge of the jointer table. Ensure the guard is pressing against the fence, and it will spring back to its original position after it is rotated away.

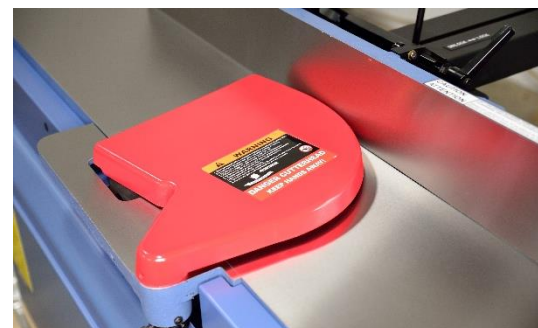

Always operate this jointer with a cutterhead guard, except for some rabbeting operations. Serious personal injury may occur when operating a jointer without a cutterhead guard.

Leveling Machine

This jointer should be positioned on a level, stable floor. If the machine is rocking on the floor, or if it vibrates excessively during operation, please adjust the rubber feet to level the machine:

1. Loosen the jam nut to unlock the leveling foot.
2. Rotating the leveling foot to adjust its height.
3. Make adjustments on all other leveling feet until the machine is completely leveled.
4. Tighten jam nuts of all adjusted leveling feet.

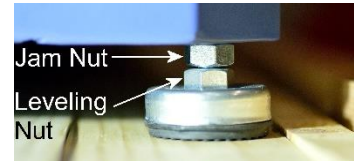

Dust Collection

This jointer can generate a lot of wood shavings and dust. Connect a dust collection system to this machine.

The minimum CFM requirement for this jointer is 700 CFM at the dust port, which means your dust collection system should have a rating greater than 700 CFM, as air friction and leakage reduce effective CFM at the dust port.

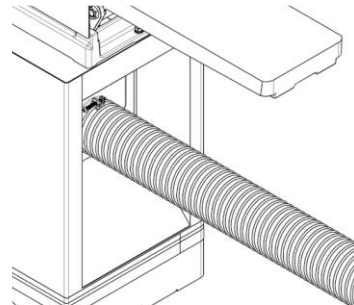

IMPORTANT

Running this jointer without a dust collection system, or using a dust collection system with inadequate suction, will cause dust and shavings to accumulate inside the jointer. This can damage the machine and cause other hazardous situations. Check your dust collection system regularly to make sure it is not jammed or filled up.

Wiring and Grounding



Deenergize the electrical circuit before touching any enclosed, electrified parts. Touching an electrified part WILL result in serious personal injury or death.



All electrical work must be done by a qualified electrician and must meet the electrical code in your area.

Make sure the voltage of your power circuit matches the power requirement of this machine, and the circuit is sized to supply power to the jointer.

Wiring Instructions

1. **Power off before connecting any wires!!**
2. Remove the screw that secures the junction box cover.



3. The wire connector inside the junction box accepts hot conductors with ring/spade terminals. The ground conductor can be connected with a wire nut.



4. Insert the power cord through the strain relief. The strain relief can be temporarily removed from the junction box to make this task easier.



5. The picture below shows an example of how a single-phase 230V model can be connected to a power source with the ring terminals and a wire nut.

Please refer to the section “Wiring Diagram” for connecting a specific model to a power source.



IMPORTANT: Always refer to local electrical code for properly connecting any machinery to a power source.

6. Hand tighten the sealing nut of the strain relief to keep the cord in place.
7. Re-install junction box cover.

Controls and Components

Control Panel



Key-Operated Main Switch

This switch enables access control to the jointer. To restrict access, lock the switch at the “OFF” position, and the power will be cut off.

Stop Button with Emergency Reset

This stop button is equipped with an emergency shutoff feature. When it is pressed, the machine will stop, and the stop button will need to be reset before the machine can start again. To reset, simply rotate the serrated-edge rim. The button will pop up when it is reset.



Start Button

When this machine is unlocked and the emergency stop button is reset, press START will start the machine.

Infeed Table Height Adjustment

The infeed table height adjustment handwheel is located right below the control panel:

- Turn **CLOCKWISE** to raise the table.
- Turn **COUNTERCLOCKWISE** to lower the table.
- The handle of the handwheel can be folded down as needed.

The depth of cut scale next to the handwheel indicates the position of the infeed table.



Infeed Table Depth Stop Knob

As a safety feature, a depth stop is set up to prevent the depth of cut goes beyond 1/8" for jointing operations. To get more than 1/8" depth of cut for rabbeting operations, pull and hold the knob when lowering the infeed table.



Outfeed Table Height Adjustment

The outfeed table height adjustment lever is located below the outfeed table. The outfeed table height is locked by a locking cap screw.

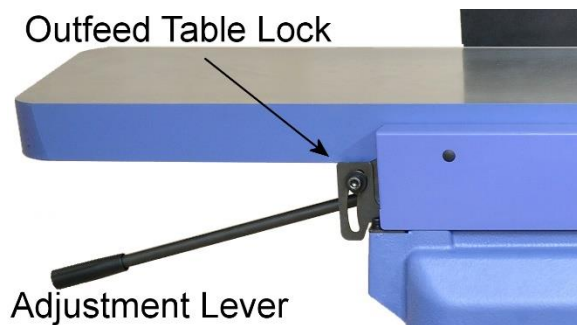

Fence

This precision ground cast iron fence has two adjustable positive stops at 90° and 135°.

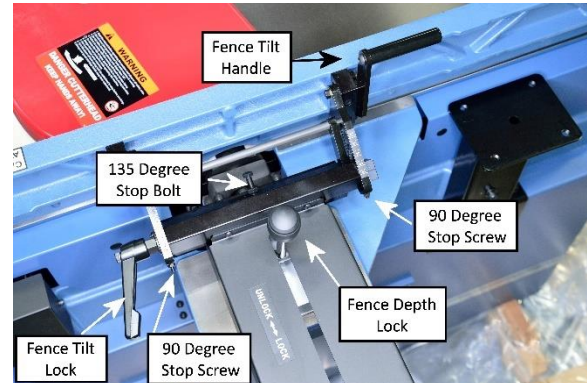

The fence can be retracted and raised above the table to provide additional clearance for servicing the cutterhead.

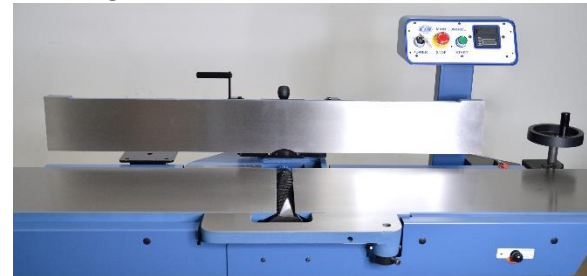

Digital Readout (DRO)

This jointer is equipped with a Wixey DRO with 0.005"/0.05mm resolution.



On/Off Button

To turn on/off this DRO. It is also for calibration in ABS (absolute) mode.

MM/IN Button

Toggles between measurement unit inch and mm. When the reading gets close to a multiple of 1/32, its fractional value will show on the screen.

ABS/INC Button

Toggles between **Absolute** and **Incremental** mode.

The absolute mode shows the total depth of cut. Once calibrated, the setting will be memorized unless the battery is exhausted, OR if a user recalibrates the DRO.

The incremental mode shows the distance the infeed table traveled since the last reset. The readings can be reset by leaving the incremental mode.

DRO Calibration

1. **Disconnect jointer from power source!!**
2. Set infeed table depth of cut to zero.
3. Turn on DRO and switch to ABS mode.
4. Hold the ON/OFF button for 3-5 seconds until "ABS" is blinking on display. As the button is released, readings will be reset to zero.
5. Press the ON/OFF button again to leave calibration mode.

Test Run

Each jointer has been inspected and calibrated before leaving the factory to meet our quality and precision standards. Due to various reasons, this jointer may need to be re-adjusted when it arrives at your workshop. It is recommended to complete this test run before using the jointer for production work, and repeat if the jointer is relocated.

Complete these quick tests to verify components are functional.

1. Remove all tools and debris from the machine. Ensure the jointer is disconnected from the power source.
2. Set the fence to 90 degrees. Move and lock the fence all the way back to expose the entire jointer table. Ensure the cutterhead guard is pushing against the fence. Rotate the guard to expose the entire cutterhead, then gently release the guard. The cutterhead guard should spring back to its original position.

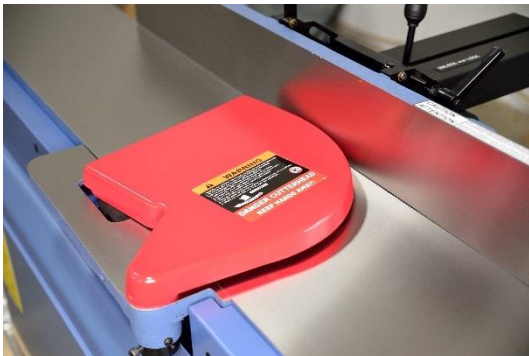

WARNING: If the cutterhead guard fails to push against the fence, STOP HERE. Adjust guard tension before resuming the test run.

3. Use the provided key to turn the main switch to the OFF position, and press the emergency STOP button.
4. Connect the machine to the power source.
5. Press the START button. The machine should not turn on.
6. Turn the main switch to ON, and press the START button. The machine should not turn on.
7. Reset the emergency STOP switch by rotating it clockwise. The button should pop up. Press the START button, and the machine should turn on. The machine should be running with no excessive noise and vibration.
8. Disconnect the machine from the power source while it is running, then reconnect the machine to power. The machine should **NOT** restart.
9. Turn on DRO. Rotate the infeed table adjustment handwheel to raise/lower the infeed table. DRO's readings should reflect movements of the table, and the table should stop at 1/8" when is lowered without disengaging the depth stop.
10. Set infeed table depth of cut to 1/32".
11. Turn on the dust collection system, and surface plane a test workpiece. See section "Surface Planing" on page 32 for detailed instructions. The workpiece should move through the jointer with ease.
12. Inspect the workpiece for unusual tear outs and other defects.

Congratulations! You have completed the test run! Now your jointer is ready for production work. If you discover any issues from the tests, please refer to the troubleshooting section and maintenance section to diagnose issues and make adjustments.

Operation

Preparation

For safety and to achieve the best results, please take the following steps before jointing a workpiece.

Inspect Workpiece

Only use this jointer for natural, quality wood materials. Cracked stock, board with loose knots, plywood, and other engineered wood products can break apart and cause severe kickbacks, which can lead to severe injuries and machine damages.

Do not use this jointer to cut treated lumber or anything that contains harmful chemicals. This will spread wood dust that contains such harmful chemicals.

Inspection

Carefully inspect workpieces for foreign objects. Nails, staples, rock chips, and other objects embedded on the wood surface will damage the jointer. It is advised to clean a workpiece with a stiff brush to remove all dirt and foreign objects ahead of time, especially for rough sawn or reclaimed lumber. Use a metal detector to scan for metal objects as needed.

Check Dimensions

To avoid accidental contact with the cutterhead, NEVER process stock that is:

1. Shorter than 12"
2. Thinner than 1/2", or
3. Less than 2" wide (for surface planing).

Support Long Workpiece

Support long stock with rollers or other devices to avoid injuries. This also helps to create a smooth, consistent finish.

Check Moisture Content

Check the moisture content of workpieces. "Green wood" with moisture content over 20% will not cut properly and may jam the machine. Excessive moisture content will also cause the jointer's unpainted surface to rust. Besides, as the workpiece dries, the once-flattened surface can become fuzzy and warped again. It is recommended to allow a workpiece to dry and stabilize before it is processed.

Warped Stock

Avoid using severely warped boards, as they can be unstable and might cause severe kickbacks or disintegrate when it is cut.

Glue Deposits

Glue left on the workpiece surface can dull cutters and lower cut quality. Scrape off all glue deposits from the workpiece before jointing a workpiece.

Inspect Wood Grain

To achieve optimal results, cut WITH the grain. Inspect the wood grain from the side of a workpiece to determine the feed direction. Avoid cutting against/across/end grain as severe kickback and chipping may occur.

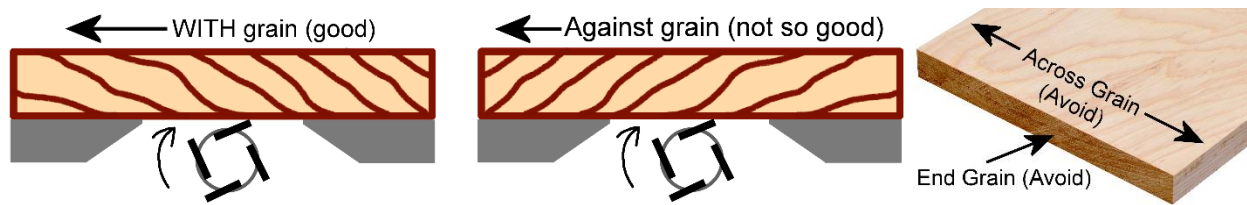

Sometimes it is impossible to cut with the grain for the entire length of a workpiece. In this case, try feeding the workpiece in opposite direction and see what works best. Reducing the depth of cut and feed rate can also help to improve cut quality.

Squaring Stock

Jointer is commonly used in conjunction with planer and table saw for squaring stock. Rough, warped stock is milled so it becomes flat and square. It takes four steps for squaring stock:

It takes four steps for squaring stock:

1. Surface Planing - The bottom face of the stock is flattened by a jointer. The concaved face should be chosen for this step.
2. Thickness Planing - The top face of the stock is flattened by a thickness planer. In this step, the workpiece can be planed down to the desired thickness.
3. Edge Jointing - The concaved edge is straightened and squared on a jointer.
4. The last edge is straightened with a rip cut on a table saw, with the jointed edge placed against the table saw fence. In this step, the workpiece can be cut to the desired width.

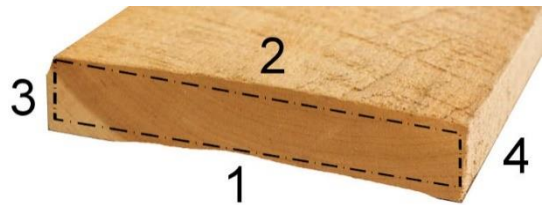

Serious injury or death can result from machine kickback or accidental contact to the cutterhead. Follow these safety rules to reduce your risks for all jointing operations:



WARNING

- Begin operation with the concave, or the most stable surface for jointing.
- Feed stock with a stable stance and at a steady rate.
- Use eye and ear protection devices.
- Cutterhead guard must be installed for all jointing operations.
- Keep hands at least 3" away from the cutterhead.
- Use push blocks whenever possible.



CAUTION

Ensure the dust collection system is functional and use a dust mask. Inhaling harmful airborne particles can cause serious, long-term health issues.

Surface Planing

1. Inspect stock for quality issues and grain orientation before the operation. Begin surface planing with the concave face when present (see examples on the right).
2. Adjust the depth of cut by setting the elevation of the infeed table. Woodworkers typically set the depth of cut to 1/16" or less to allow better control over the workpiece, and to reduce wastage.

If needed, this jointer is capable of removing 1/8" of materials per pass.

3. Set the fence to 90°.
4. Start the jointer and the dust collection system.
5. To initiate a cut, stand near the infeed table and slightly behind the cutterhead. Place the workpiece on the infeed table. Use the push block in the left hand to feed stock against the fence and the infeed table, and use the push block in the right hand to feed the stock from the back.

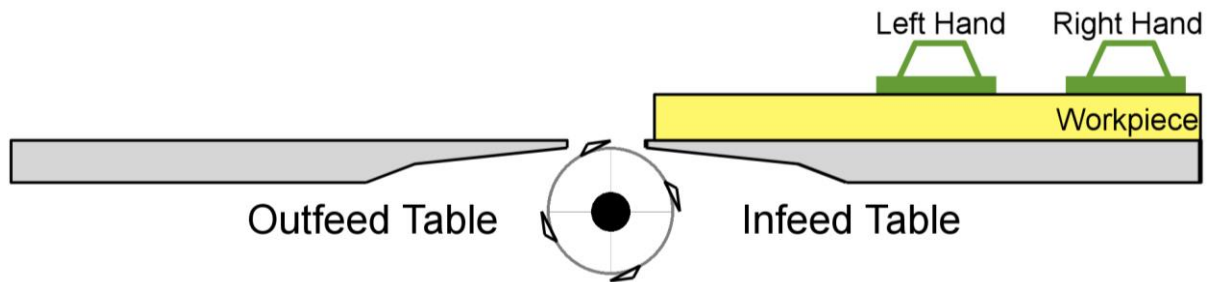
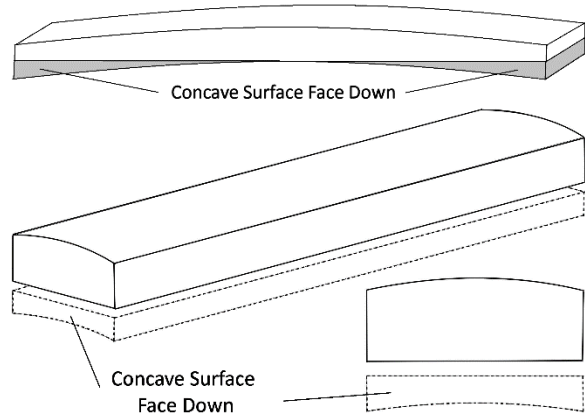

6. Feed a small section of the workpiece across the cutterhead. Keep it under control but do not apply excessive pressure to bend it flat on the table.

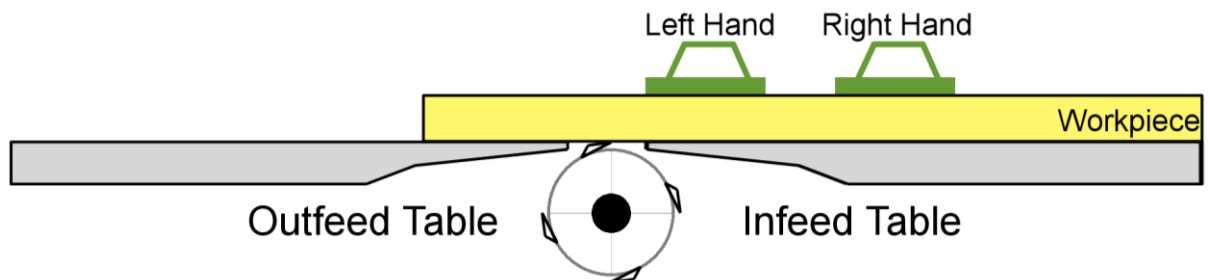

7. As the left feeding hand approaches the cutterhead, stop feeding. Carefully lift the left-hand push block and use it to feed the portion of the workpiece that is on the outfeed table. Maintain control of the workpiece with the right hand while repositioning the left hand.

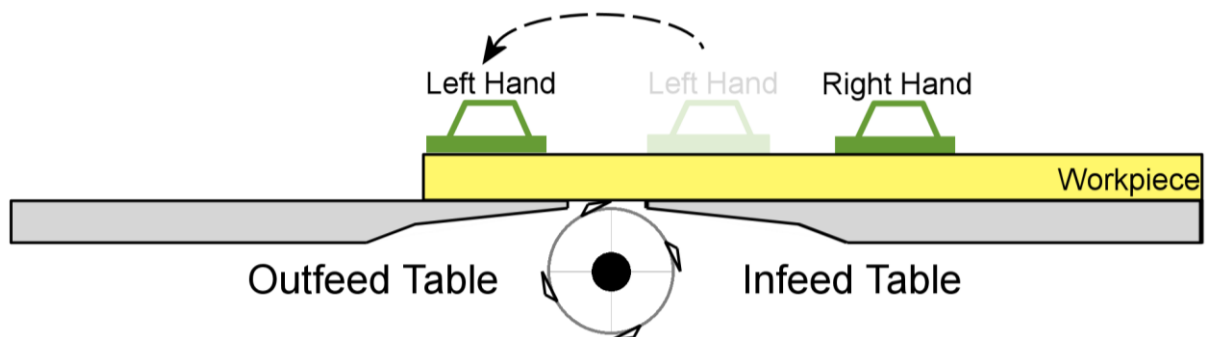

- As the right feeding hand approaches the cutterhead, stop feeding. Carefully lift the right-hand push block and move the entire body towards the outfeed table. Place right-hand push block on the stock that sits on the outfeed table. Use the left hand to maintain control of the stock while repositioning the right hand.

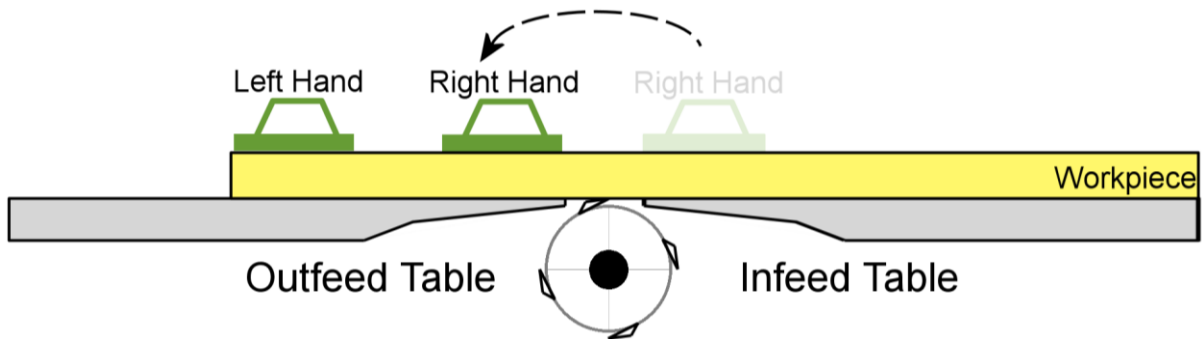

- From this point on, continue to feed stock only on the outfeed table until the entire length of the stock is planed. Feed stock at a steady rate to produce a smooth surface with no burn marks.
- If the stock cannot be flattened in a single pass, repeat steps 5-9 until the entire surface is cut flat.

TIP: For new jointer users, practice stock feeding with the depth of cut set to 0". This helps to perfect the feeding technique before actual operations.

TIP: To ensure the entire surface is cut, some woodworkers leave pencil marks on the entire length of stock before the final passes, then verify all marks are removed after a pass.

TIP: Do not feed thin stock with excessive downward pressure. This will flatten any cup or warp workpiece as it passes through the cutterhead, but it will spring back to its original shape when pressure is released. Only apply adequate pressure to maintain control of the stock when feeding.

Edge Jointing

1. Set the fence to 90°.
2. Inspect stock for quality issues and grain orientation. Make sure the stock has a flat surface to feed against the fence. For crooked stock, begin edge jointing with the concaved edge.

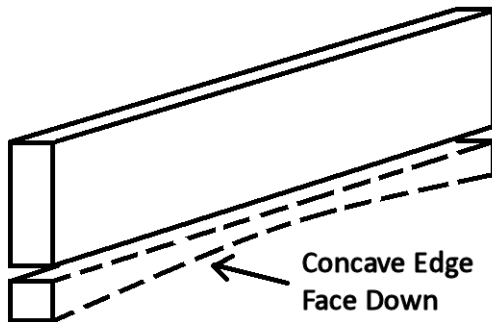

3. Set the depth of cut. If an edge is almost flat and squared, set the depth of cut to only remove as much material as needed to obtain a jointed edge. This jointer can remove at most 1/8" of materials per pass.

Stock that has a rough edge may take multiple passes to joint it straight and squared. For some extreme cases, consider using a saw and a special jig to create a roughly straight edge before jointing.

4. Start the dust collection system and the jointer.
5. Place the workpiece on the infeed table, then use push blocks to hold it against the fence and the table to initiate a cut.



Be very careful when jointing narrow boards. Use push blocks to keep hands away from the cutterhead. Position both hands and the push blocks above the cutterhead guard when feeding.

When edge jointing a board that is much taller than the fence, using the right hand to hold the board will provide better control. Continue to use a push block on the left hand to keep it away from the cutterhead.

Be sure the right hand is securely resting on top of stock and it is away from the cutterhead at all times.

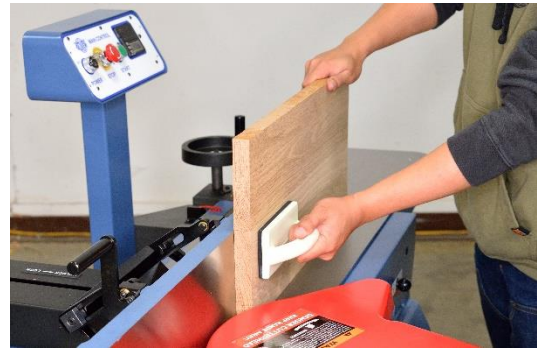

6. Feed the entire length of the stock through the cutterhead. Maintain a stable, balanced stance for the entire process.
7. For long stock, feed a section past the cutterhead, then continue to feed the remaining length while standing next to the outfeed table.
8. Repeat the process until the entire edge is jointed flat and square.

TIP: Occasionally adjust fence position to make use of the outboard edge of the cutterhead. This helps to average the use of the cutters.

Beveling

Instructions and precautions for edge jointing apply to beveling. Besides:

- When cutting a bevel that is not 90°, lift up the 90° fence stop block, then set the fence tilt to the desired angle of cut using a protractor.
- Reduce the maximum depth of cut from 1/8" to 1/16" or less based on the width of the bevel and hardness of the workpiece.

Rabbet Cutting

A rabbet is a groove cut along the edge of a workpiece. This jointer is capable of making rabbet cuts as deep as 3/4". Depending on the requirements and constraints of your project, a jointer, or other tools such as a table saw, router, or other hand tools, can be the best tool for your rabbeting needs. Always consider safety when choosing a tool for rabbeting.

Performing a rabbet cut with this jointer may require the cutterhead guard removed. Promptly re-install the guard after the rabbeting operation completes.

1. **Inspect stock for quality issues before the operation. The surfaces for rabbeting must be flat and squared.**

2. Set fence to 90°

3. Reposition the fence to set the width of a cut. The amount of exposed cutterhead is the width of the rabbet.

Please beware that the cutters are installed in staggered formation, and the outermost edge of the cutter is located near the edge of the table. Make test cuts to confirm the width of the cut as needed.

The fence travel is 10-3/4" leaving approximately 1-1/4" as the minimum width to rabbet. If the desired rabbet cut is less, an auxiliary fence must be built and secured to the jointer fence.

4. Remove the cutterhead guard as needed.

5. Start the jointer and dust collection system.

6. Place workpiece against the fence and infeed-rabbeting table. Use push blocks whenever permissible.



7. Follow steps [5-9] in "Surface Planing" for feeding stock through the jointer. Repeat the process until reaching the desired depth of the rabbet cut.

CAUTION: Beware that the rabbeting table is short and narrow. Take extra caution and support of the entire workpiece throughout the operation.

8. Lower the infeed table gradually to remove a portion of the material in each pass until reaching the desired depth of cut. As much as 1/8" of materials can be removed per pass.

CAUTION: For safety, never cut more than 1/8" per pass.

9. Disengage the infeed table depth stop when the infeed table needs to go below 1/8". This jointer can produce a rabbet that is 3/4" deep.



10. Reinstall cutterhead guard after the rabbeting operation.



WARNING

If the cutterhead guard is removed for rabbeting operation, use extreme caution when performing cuts. Reinstall the guard immediately when the operation completes.

Common Cutting Problems

Snipe

Occurs when too much pressure is applied as a workpiece enters or leaves the cutterhead. Improper table settings can also introduce snipes.

To mitigate this problem, apply even feed pressure throughout the entire workpiece. Once the workpiece went past the cutterhead, downward pressure should be focused on the outfeed table only. Ensure the outfeed table is not positioned way below the cutter head.



Chipping

Happens when cutting against the grain direction. For highly figured lumber, and areas near a knot, some amount of chipping is normal. In this case, reduce the depth of cut and feeding speed. Moistening the problematic area before jointing can sometimes mitigate the issue.

Chipping can also be caused by dirty or dull cutters. If chipping happens while jointing straight grain stocks, inspect the cutter inserts and remove all resin buildups. Rotate/replace dull cutter inserts.



Fuzzy Grain

Can happen when planing wood with high moisture content or if the cutter is dull. Sometimes it is impossible to avoid fuzzy grain due to the nature of certain wood types. To mitigate this issue, avoid using wood with high moisture content and use sharp cutters.

Accessories

Oliver Machinery has a collection of accessories and add-ons to enhance the productivity of your jointer. Please visit our website OLIVERMACHINERY.NET to purchase these items.

You may also call **1-800-559-5065** or email PARTS@OLIVERMACHINERY.NET to place an order. We are available Monday through Friday, 7:30 AM - 4 PM Pacific Time.

460V Conversion Kit



This 460V Conversion kit allows you to convert a three-phase model (**4275.102.4S**) that is pre-wired to 230V to operate on 460V. Installation of this kit should be done by a qualified electrician. You may also order the 460V three-phase model directly from Oliver Machinery. We can pre-install this kit for you.

Parts number:

490716-000 440V Magnetic Contactor

490234-000 440V Overload RA-20

Cutter Inserts



Genuine four-sided indexable carbide cutter insert that will fit the cutterhead of Oliver **4275C Jointer**.

Parts number: **P-15mm 4S**

Touchup Paint



Keeping all painted surfaces in good condition not only makes your machine look nice but also keeps rusts away. Oliver Machinery has pre-mixed spray paint available in Oliver-Blue for purchase.



WARNING

Using unapproved accessories may cause this machine to malfunction, resulting in serious injury and/or machine damage. Only use accessories recommended for this machine.

Power Feeder

Two models of power feeders are available for the 4275C Jointer. They can be installed on the power feeder mount located behind the outfeed table.

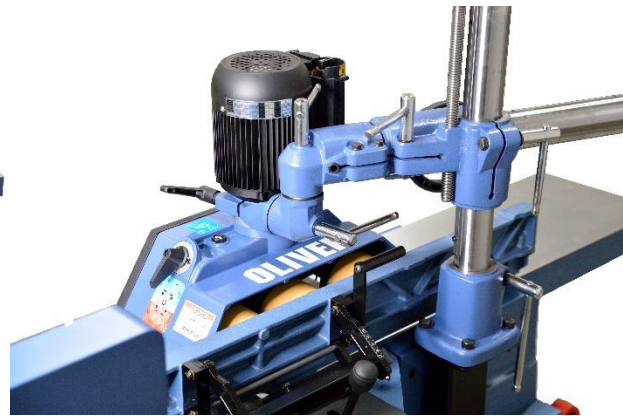

Features

- Polyurethane covered rollers provide excellent grip while protecting the work surface.
- Eight feed speeds and choice of three or four rollers to fit any application.
- Versatile stand allows adjustment of 10" in height and 18" in reach.
- Powerful TEFC motor is available in single or three-phase.
- CSA Listed



Model	APF0038
Stock Number	APF0038.001 1HP, 1Ph, 230V (4.2A)
Stock Number	APF0038.002 1HP, 3Ph, 230V (3.4A)
Number of Rollers	3
Roller Size	4-3/4"(D) x 2-3/8"(W)
Feed Speed	8 Speeds: 6.5 / 13 / 18 / 22 / 36 / 43 / 55 / 108 FPM
Net Weight	137 lbs.



Model	APF0048
Stock Number	APF0048.001 1HP, 1Ph, 230V (4.2A)
Stock Number	APF0048.002 1HP, 3Ph, 230V (3.4A)
Number of Rollers	4
Roller Size	4-3/4"(D) x 2-3/8"(W)
Feed Speed	8 Speeds: 6.6 / 13 / 18 / 22 / 36 / 43 / 55 / 108 FPM
Net Weight	146 lbs.

Please visit our website at WWW.OLIVERMACHINERY.NET/ACCESSORIES for other recommended accessories.

Maintenance

Routine maintenance keeps your jointer in top shape. Please follow the maintenance schedule below, and use the maintenance record worksheet attached in the back of the manual to document all tasks completed. **NOTICE:** Maintenance schedule may vary for individual users due to different situations and safety requirements.

 WARNING	Disconnect the machine from the power source before any maintenance work is performed. After servicing the jointer, remove all wrenches and tools before restarting the machine. Failure to comply can cause serious injury!
---	---

Maintenance Schedule

Interval	Task
Every day	Remove dust buildups from the jointer and dust collection system.
	Inspect the power cord for signs of aging and damages. Replace as needed.
Every week	Inspect and clean the cutterhead. Remove any dust and resin accumulation.
	Inspect/rotate/replace worn cutter inserts.
	Apply rust protectant on unpainted cast iron surfaces.
	Verify infeed/outfeed tables are coplanar.
Every month	Check V-belt tension and replace if the belt shows signs of cracking or glazing.
Every 6 months	Lubricate worm gears with grease.

Notice: Motor bearings are permanently sealed and lubricated and do not require lubrication.

Inspect / Adjust Jointer Tables

Each jointer has been inspected and calibrated in the factory and should not require adjustments initially. When a jointer consistently makes problematic cuts, perform these checks, and make adjustments as needed.

Inspect Outfeed Table Height

1. **Disconnect jointer from power source!!**
2. Put on leather gloves.



3. Remove cutterhead guard.
4. Move fence assembly all the way back to expose the entire table.
5. Place a straight edge over the centerline of the outfeed table so it hangs over the cutterhead.

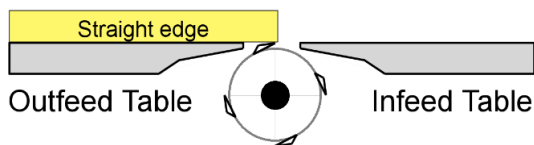
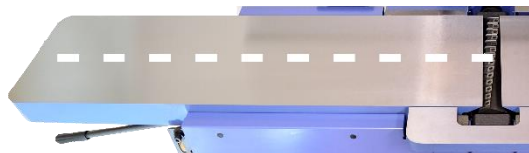

6. When the outfeed table height is properly set, cutters should be barely scraping the straight edge when the cutterhead rotates. Follow the next section to make adjustments as needed.

If the outfeed table height is set properly, jump to section “**Inspect Outfeed Table Parallelism**”.

Adjust Outfeed Table Height

1. **Disconnect jointer from power source!!**
2. Loosen the cap screw that locks the outfeed table.

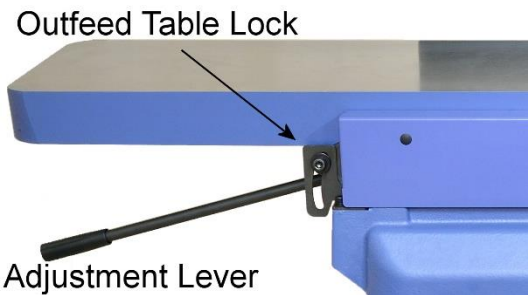

3. Adjust outfeed table height with the lever. With a straight edge sitting on the outfeed table, cutters should be barely touching the straight edge when the cutterhead rotates.
4. Below the base of the lever, there are two stop bolts for setting the maximum and minimum height of the outfeed table.

If these stop bolts need to be adjusted, loosen the jam nuts, and retighten them after adjustments.

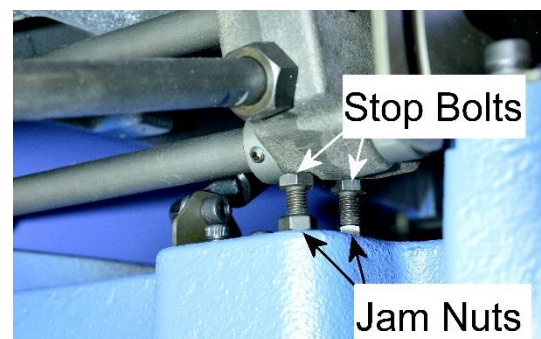

5. When the height of the outfeed table is adjusted, tighten the locking cap screw to lock its height.

Inspect Outfeed Table Parallelism

1. **Disconnect the jointer from the power source!!**
2. Place a straight edge on the outfeed table in positions as shown below:



3. Make sure the straight edge is hanging above the cutterhead:

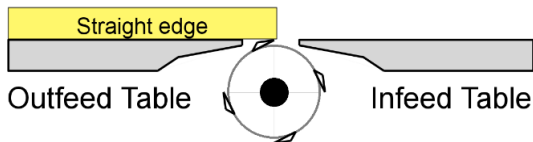

4. In each position, carefully rotate the cutterhead. When the outfeed table is in parallel with the cutterhead, cutters should be barely scraping the straight edge when the cutterhead rotates.
5. If the outfeed table and cutterhead are out of alignment, move to section “**Adjust Table Parallelism/Coplanarity**”.

If the outfeed table is in parallel with the cutterhead, proceed to the next section “**Inspect Infeed Table**”

Inspect Infeed Table

1. **Disconnect the jointer from the power source!!**
2. **NOTICE:** Make sure the outfeed table is properly adjusted before continue.
3. Place a straight edge that splits evenly on both the infeed and the outfeed table.
4. Raise the infeed table so that it is at the same height as the outfeed table. When proper height is set, the straight edge will sit flat and flush on the infeed and the outfeed table. Rotate carbide cutter away if it contacts the straight edge.
5. Move the straight edge across the tables in positions as shown in the picture below. Rotate carbide cutter away if it gets in the way.

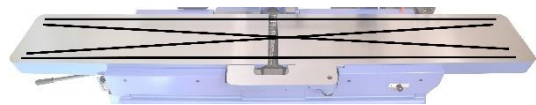

6. In each position, the straight edge should sit flat and fit flush on both infeed and outfeed tables.
7. If infeed/outfeed tables are out of alignment, move to section “Adjust Table Parallelism/Coplanarity”.
8. Otherwise, congratulations! The jointer tables are well calibrated for your next project!

Adjust Table Parallelism/Coplanarity

Adjusting table parallelism and coplanarity take time, precision, and patient. The entire process can take over an hour or more. Check the amount of misalignment against tolerance before making adjustments.

For best results, use a long and precise straight edge for adjustments.

Measurement	Tolerance
Outfeed Table / Cutterhead Parallelism	$\leq 0.004''$
Infeed / Outfeed Table Parallelism	$\leq 0.01''$

For best results, a long and precise straight edge is required for adjustments.

1. **Disconnect jointer from power source!!**
2. Remove the depth stop knob.



3. Remove the cutterhead cover.

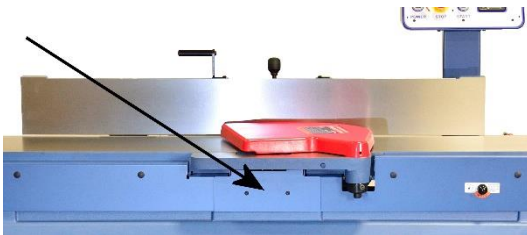

6. This picture shows the jointer with the parallelogram mechanism exposed. Table parallelism /coplanarity can be adjusted by rotating the eccentric nuts on the shafts [1-4]. There is a pair of eccentric nuts located on each end of these shafts.

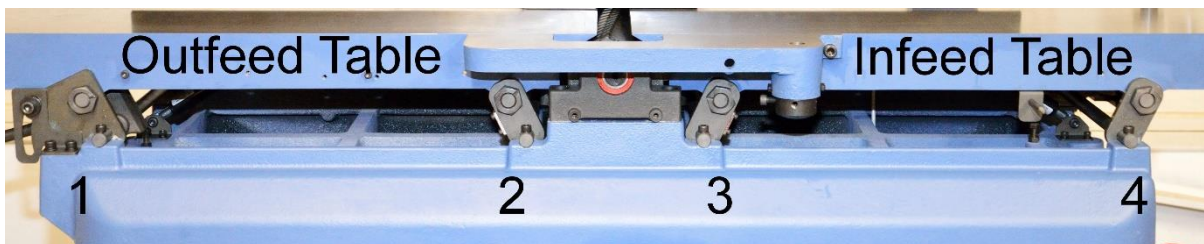

4. Remove all metal four metal panels that conceal the parallelogram mechanism.

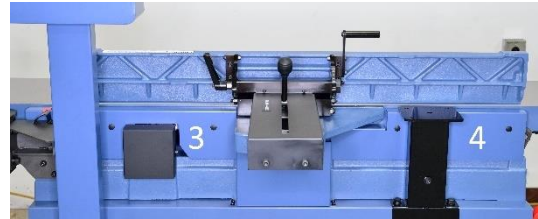

5. Each panel is secured by two cap screws, which are covered by plastic caps. Use a straight head screwdriver to remove the plastic cover, then remove the hex cap screw with a 5mm hex wrench.

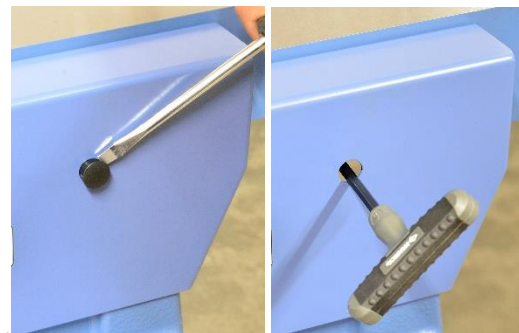

7. Locate and loosen the set screws for locking the eccentric nuts as shown in the pictures:

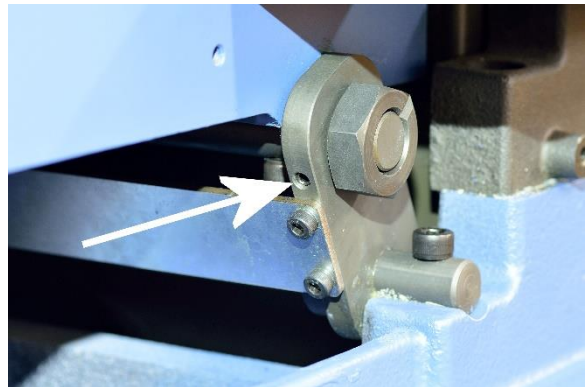
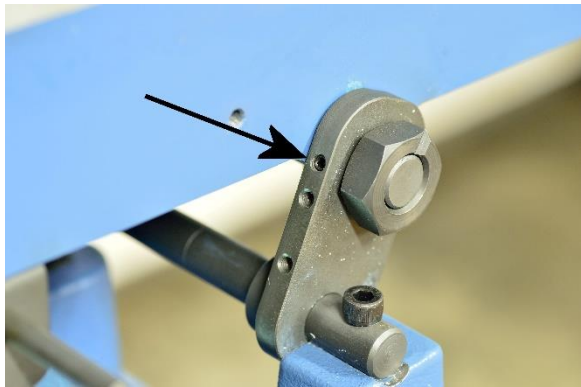
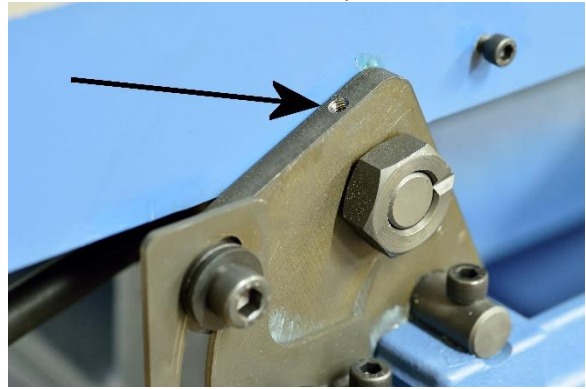
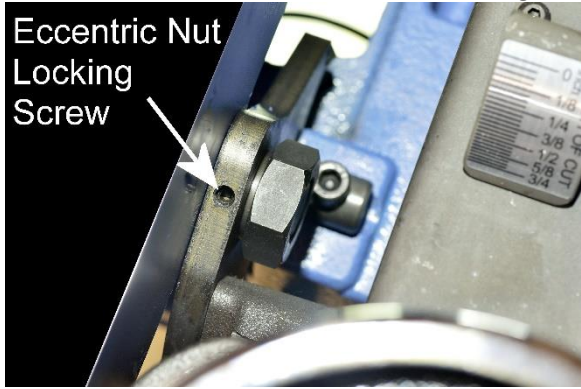

8. The eccentric nuts should be fairly loose once they are unlocked. Rotate the eccentric nuts to align the outfeed table and cutterhead.
9. **IMPORTANT:** While rotating the eccentric nuts, ensure they are pushed against the holding bracket. Leaving any gaps in between may cause the table to shift sideways.

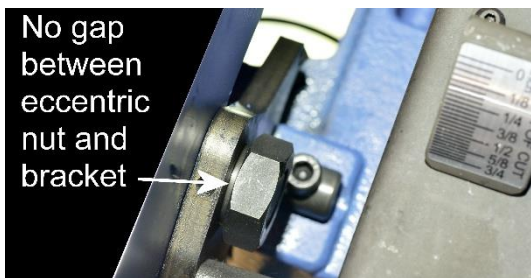

outfeed table is rocking, eliminate all gaps between eccentric nuts and the bracket.

13. Adjust the infeed/outfeed table parallelism using the infeed table eccentric nuts. Repeat the steps in "Inspect Outfeed Table Parallelism" when making adjustments. Again, leave no gaps between the eccentric nut and the bracket.
14. Lock all eccentric nuts after adjustments.
15. With the infeed table realigned, it may need additional adjustments. See section "**Infeed Table Adjustments**" for details.
16. Reinstall all panels and cutterhead guard when all adjustments are done.

10. Repeat the steps in "**Inspect Outfeed Table Parallelism**" to verify adjustments.
11. Retighten the set screws to lock all outfeed table eccentric nuts after adjustments.
12. With the fence locked, gently rock the fence to ensure the outfeed table is stable. If the

Infeed Table Adjustments

After a full table realignment, the infeed table height should be re-zeroed, and a few components of the infeed table will need to be adjusted.

1. **Disconnect the jointer from the power source!!**
2. To re-zero the infeed table height, raise the infeed table so it is approximately at the same height as the cutting arc of the cutterhead.
3. Place a straight edge over the infeed table so it hangs over the cutterhead.

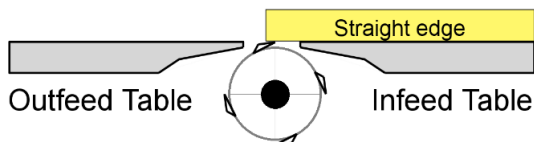

4. Fine-tune the table height to set the depth of cut to zero. When properly set, cutters should be barely scraping the straight edge when the cutterhead rotates.
5. With the infeed table height zeroed, follow the steps in **"DRO Calibration"** to re-zero the digital readout.
6. Check if the infeed table height scale is still pointing at zero. If not, loosen the 2 hex screws and readjust the pointer.



Infeed Table Positive Stops Adjustments

Under the infeed table, there are three positive stops:

Minimum Depth Stop - When properly adjusted, it should stop the infeed table when the depth of cut is between 0"-1/32".

Maximum Depth Stop - Prevents the infeed table from lowering too much and getting more than 3/4" depth of cut.

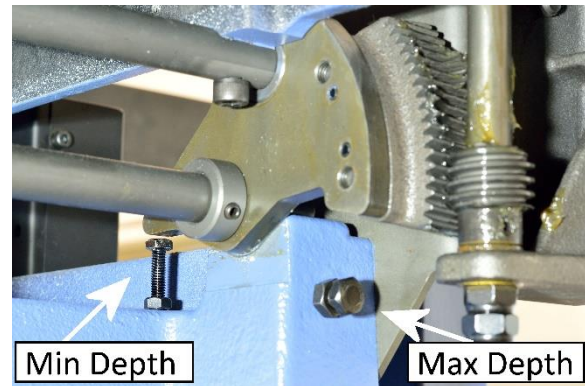

Depth Stop for Jointing – Limits the depth of cut to 1/8" for jointing operations. This positive stop is located behind the depth stop knob, which is accessible when the panel is removed.

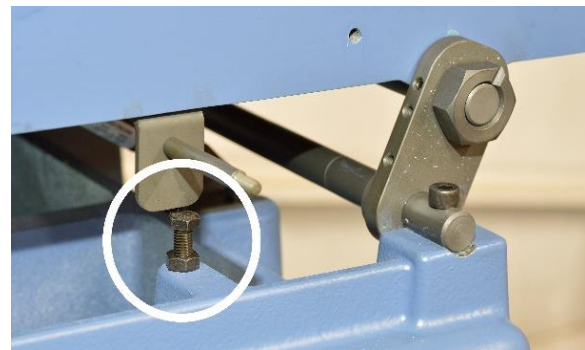

To test this depth stop, make sure the bracket as shown in the picture above aligns with the stop bolt, then lower the infeed table. If this positive stop is set correctly, it will stop the table at 1/8".

To Make Adjustments:

1. **Disconnect the jointer from the power source!!**
2. Loosen the jam nut that locks the stop bolt.
3. Rotate the stop bolt until it stops the infeed table at the correct height.
4. Re-tighten the jam nuts.

Rotate / Replace Cutter Inserts



Cutter inserts are extremely sharp. Wear thick leather gloves to avoid hand injuries.

1. **Disconnect the jointer from the power source!!**
2. Put on leather gloves.
3. Remove cutterhead guard.
4. Move the fence all the way back and raise it above the table to expose the cutterhead.

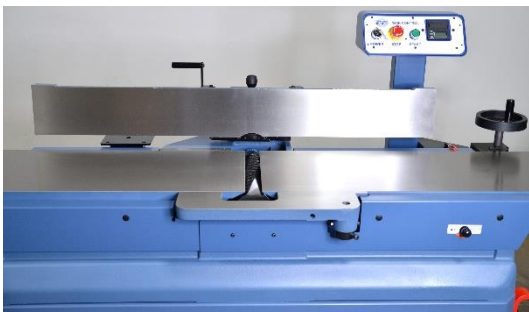

5. Remove dust and resin accumulations on cutterhead and areas nearby.
6. Inspect the cutter inserts. Rotate the cutter inserts 90° clockwise when they get dulled or nicked. Use a permanent marker to mark the new edge to be used.
7. To rotate/replace a cutter insert, remove the Torx screw with a T-25 Torx bit. Turn **COUNTERCLOCKWISE** to loosen the screw.

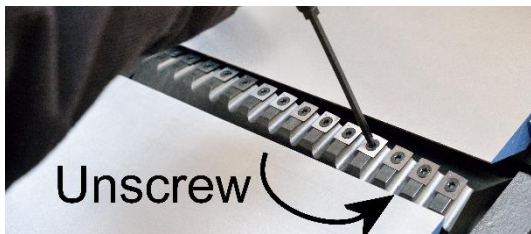

8. With the cutter insert removed from its platform, thoroughly clean the cutter insert platform with a vacuum or compressed air.



IMPORTANT: Obstacles between the insert and cutterhead platform will create uneven pressure against the insert. This will lower cut quality and may cause the insert to crack.

9. Reinstall cutter insert with the marked cutting edge facing out.
10. Inspect the Torx screw. Replace any damaged screws. Lubricate screw thread with a thin coat of lightweight machine oil.
11. Using a torque wrench, re-tighten the Torx screw with 52-60 lb-inch of torque.

IMPORTANT: Do not use an excessive amount of lubrication, or the Torx screw and the cutter insert will not sit properly.

12. Reinstall the cutterhead guard and remove all tools from the table when servicing is done.

Adjust Fence Positive Stops

The fence assembly has two positive stops at 90° and 45°. They were calibrated in the factory and should not require initial adjustments.

Adjust 90° Positive Stop

1. **Disconnect the jointer from the power source!!**
2. Loosen the fence tilt lock.
3. Loosen two jam nuts and positive stop set screws.

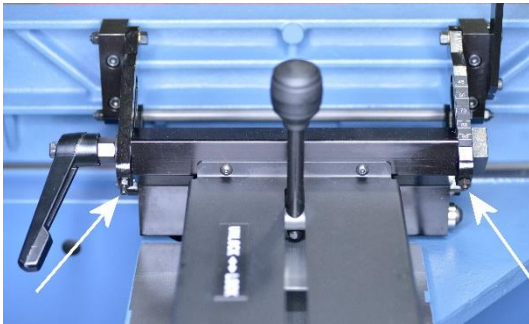

4. Use a square to set the fence at 90 degrees.

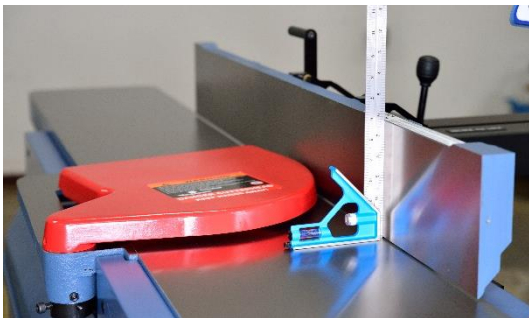

5. Rotate set screws to reset the positive stop.
6. With the set screws holding in place, tighten the jam nuts.
7. Re-check fence stop settings.
8. Lock the fence before starting the jointer.

Adjust 135° Positive Stop

1. **Disconnect the jointer from the power source!!**
2. Loosen the fence tilt lock.
3. Loosen the jam nut and positive stop bolt.

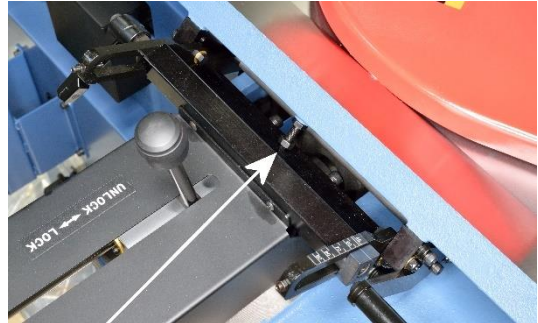

4. Use a protractor to set the fence at 45 degrees.

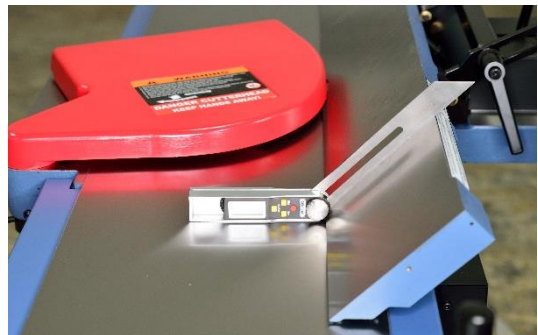

5. Rotate the stop bolt to reset the positive stop.
6. With the stop bolt holding in place, tighten the jam nut.
7. Re-check fence stop settings.
8. Lock the fence before starting the jointer.

Adjust Belt Tension



CAUTION

Belt and pulleys may be hot after operations. Allow components to cool before servicing.

1. Disconnect the jointer from the power source!!
2. Remove the motor access panel and the belt cover.

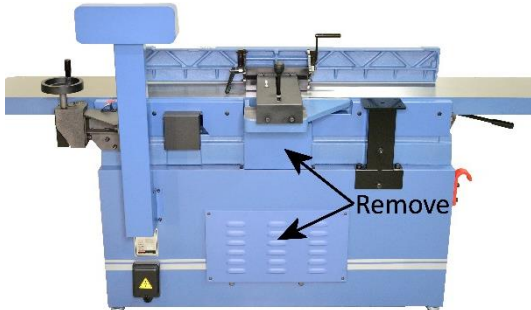

3. Apply moderate pressure on the V-belt midway between the two pulleys. Properly tensioned V-belt should deflect by approximately 1/4".

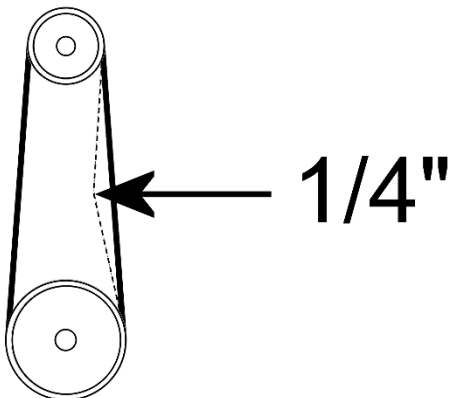

4. If V-belt tension needs to be adjusted, loosen both lower motor mounting bolts (#1). Lower the motor until proper belt tension is reached. Secure the motor mounting plate by tightening both the upper mounting bolts (#2) and the lower mounting bolts.

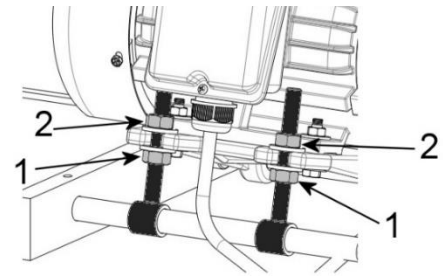

5. If V-belts need replacement, push the belt towards the motor to walk the belt out from the motor pulley.

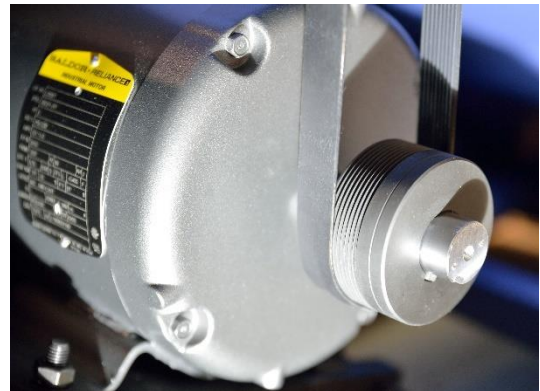

If the belt is too tight to remove, temporarily loosen the upper mounting bolts (#2). Raise the motor to loosen the belt, and remove it from the pulleys.

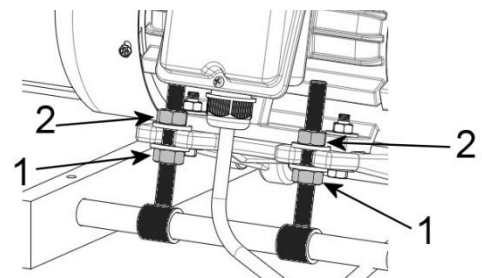

6. Install a new belt and make sure the belts sit into the grooves of pulleys.
7. Adjust belt tension and re-secure motor as needed.
8. Replace belt cover and motor access panel when maintenance completes.

Align Belt Pulleys

The belt pulleys were aligned in the factory and should not require further adjustments. Check pulley alignment if the belt is slipping off the pulleys, or if the belt wears prematurely.

1. **Disconnect the jointer from the power source!!**
2. Remove the motor access panel and the belt cover.

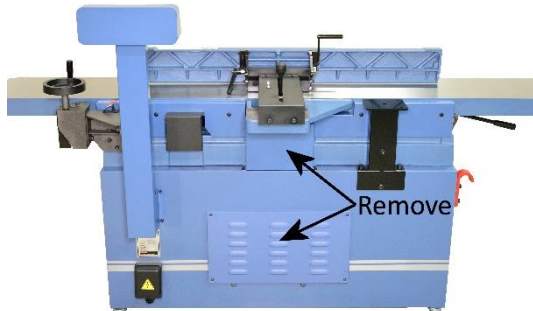

3. Use a straight edge or a tight string to check the alignment of the belt pulleys.
4. Adjustments can be made by shifting the motor pulley. Loosen the two set screws with a 5mm hex wrench, and the motor pulley can move along the motor shaft.

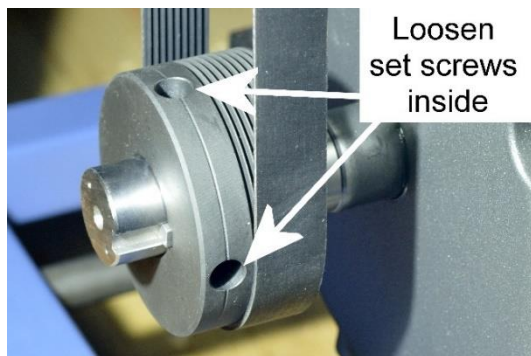

5. Realign the motor pulley with the cutterhead pulley.
6. Retighten the motor pulley locking screws, then close the belt cover and motor access panel after adjustments.

Troubleshooting

Mechanical / Electrical Issues

Problem	Possible Cause	Possible Solution
Machine does not start.	Machine is not connected to a power source.	<ol style="list-style-type: none"> 1. Make sure the machine is plugged in, or the power disconnect is at the ON position. 2. Check the electrical panel for a tripped circuit breaker or a blown fuse. 3. Ensure all electrical connections have good contacts.
	Low voltage / current.	Have an electrician check/repair the power circuit.
	Faulty switch/motor/capacitor.	Contact customer service for further assistance.
Machine trips thermal protection/circuit breaker, or blow fuses.	Machine is undersized for the operation.	Reduce the depth of cut and/or feed rate.
	Workpiece moisture level is too high.	Only joint wood with a moisture level below 20%.
	Machine is jammed.	Make sure the cutterhead is not jammed by woodchips. Check dust chute and clear blockages.
	Too much load on a circuit.	Make sure the power circuit is sized for this machine. If the circuit is shared, ensure it is sized to supply power for all items in the circuit.
	Motor/capacitor issue.	Contact customer service for further assistance.
Machine stalls during operation.	Machine is undersized for the operation.	Reduce the depth of cut. Lower feed rate.
	Dull cutters.	Rotate/replace cutter inserts.
	Belt slipping.	Clean belt and pulleys. Adjust belt tension.
	Motor/capacitor issue.	Contact customer service for further assistance.
Machine stopped during an operation.	Thermal overload protection triggered.	Hit the STOP button and wait for at least 3 minutes. When the machine is cooled down, overload protection will reset automatically. Reduce the depth of cut and feed rate before continue.

Problem	Possible Cause	Possible Solution
Outfeed table is stuck/difficult to adjust.	Outfeed table is locked.	Loosen the locking cap screw before adjusting the outfeed table.
Digital readout not functional.	Dead battery.	Replace battery.
Unable to lower infeed table below 1/8"	Depth stop is engaged.	Pull infeed table depth stop knob while lowering the infeed table. NOTICE: Only set depth of cut greater than 1/8" for rabbeting operations.
Outfeed table is loose and moves with the fence.	There is play in the parallelogram mechanism.	Check the parallelogram mechanism and eliminate any gaps between the eccentric nut, bracket, and shafts. Ensure all eccentric nuts are locked by the set screws, and each set screw is locked by blue Loctite.
Workpiece is caught on the edge of the outfeed table.	Outfeed table is set too high.	Adjust the outfeed table to ensure it is flush with the cutting arc of the cutterhead.
Uneven wear on cutter inserts	One section of cutterhead is used more than another.	Occasionally adjust fence's depth setting so the entire cutterhead is utilized.
Machine vibrates excessively or makes unexpected noise.	Damaged cutter inserts.	Replace cutter inserts.
	Machine stands on an uneven floor.	Reposition machine on a flat, level surface. Adjust leveling feet.
	V-belt worn, slipping, or hitting belt cover.	Clean belt and pulleys. Adjust belt tension. Replace V-belt if it shows signs of aging.
	Improper motor mounting.	Check and adjust motor mounting.
	Loose components.	Tighten fasteners of the component.
	Worn bearings.	Contact customer service for assistance.

Operation / Quality-Related Issues

Problem	Possible Cause	Possible Solution
Workpiece came out twisted.	Improper feeding.	Use the outfeed table as the reference point for feeding. Apply even pressure and feed rate on the entire workpiece.
	Outfeed table is not in parallel with the cutterhead.	Ensure the outfeed table is in parallel with the cutterhead, and the outfeed/infeed tables are coplanar.
	More passes are needed.	Significantly twisted boards take multiple passes to flatten.

Problem	Possible Cause	Possible Solution
Excessive snipe	Outfeed table is too low.	Adjust the outfeed table to ensure it is flush with the cutting arc of the cutterhead.
	Too much downward pressure when feeding the end of a workpiece.	Once the workpiece reaches the outfeed table, use the outfeed table as the reference. Reduce feeding pressure apply to the workpiece that is still on the infeed table.
Chipping	Too much material was removed in one pass.	Reduce the feed rate or the depth of cut.
	Planing across/end grain.	Do not use a jointer to cut across/end grain.
	Damaged cutter.	Rotate/replace cutter insert.
	Cutting against grain; or knots.	Avoid processing workpieces with knots. Cut WITH grain whenever possible. When jointing a workpiece with complicated grain pattern, reduce the depth of cut. Sometimes moistening problematic areas can reduce chipping.
Fuzzy looking finish.	Wood moisture content is too high.	Only process wood with less than 20% moisture content.
	Dull cutter.	Rotate/replace cutter insert.
	Some wood types tend to have fuzzy grain.	Adjust feed rate or the depth of cut. Use sharp cutters.
Glossy looking finish.	Dull cutter.	Rotate/replace cutter insert.
	Cutting depth is too shallow.	Increase depth of cut.
Long line or ridges running along the length of the board.	Chipped cutter.	Rotate/replace cutter insert.
Finished stock has uneven front-to-back thickness.	Cutterhead is not flush with the outfeed table.	Adjust the outfeed table to ensure it is flush with the cutting arc of the cutterhead.
	Inconsistent feeding pressure applied to the workpiece.	Apply even feeding pressure on the workpiece. Keep feed rate consistent.
Finished stock is concave/convex in the middle.	Infeed/outfeed table are not coplanar.	Ensure the outfeed table is parallel with the cutterhead, and the outfeed/infeed tables are coplanar.

Wiring Diagram

For Stock # 4275C.101.4S (230V, 1Ph)

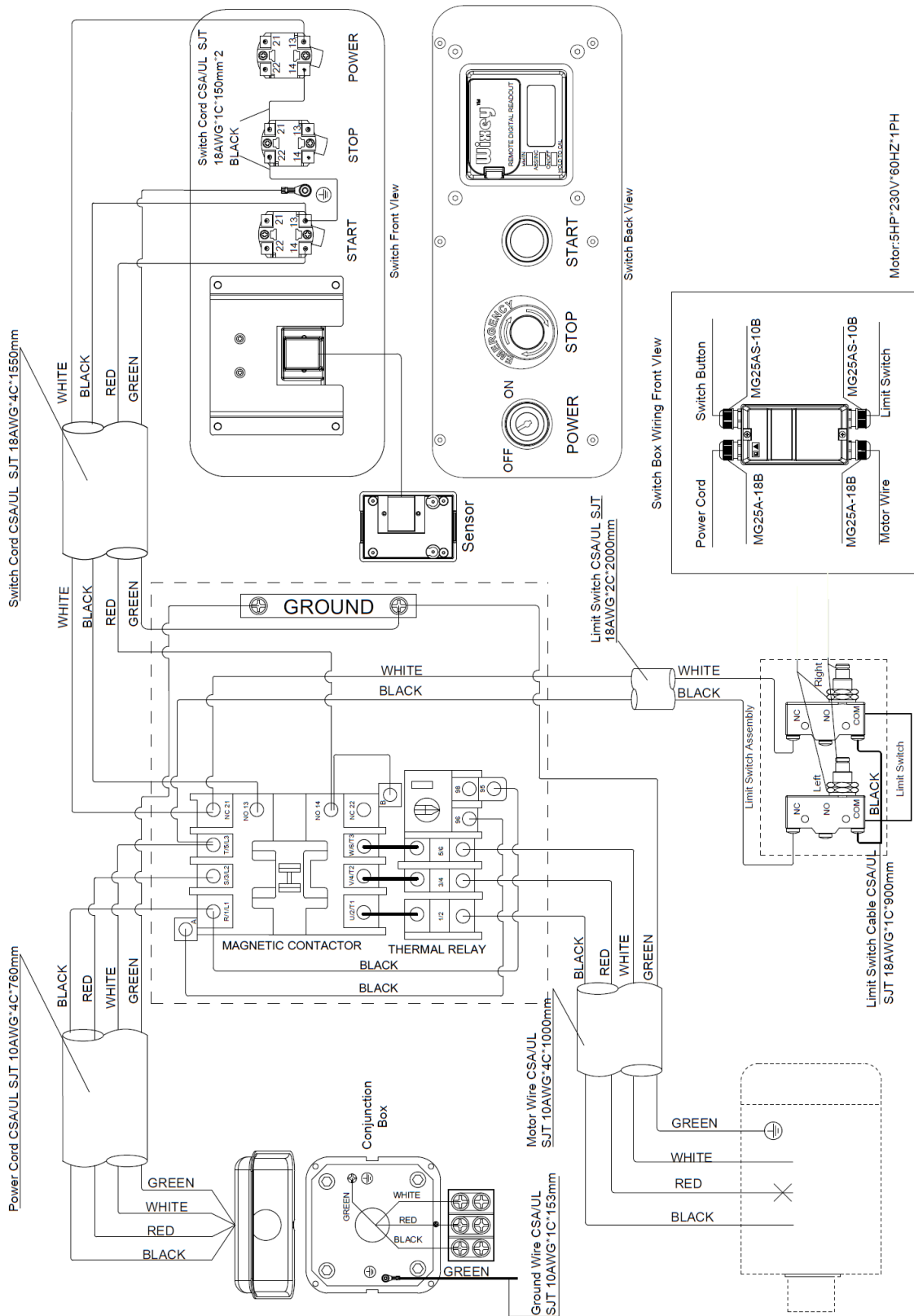

For Stock # 4275C.102.4S (230/460V, 3Ph)

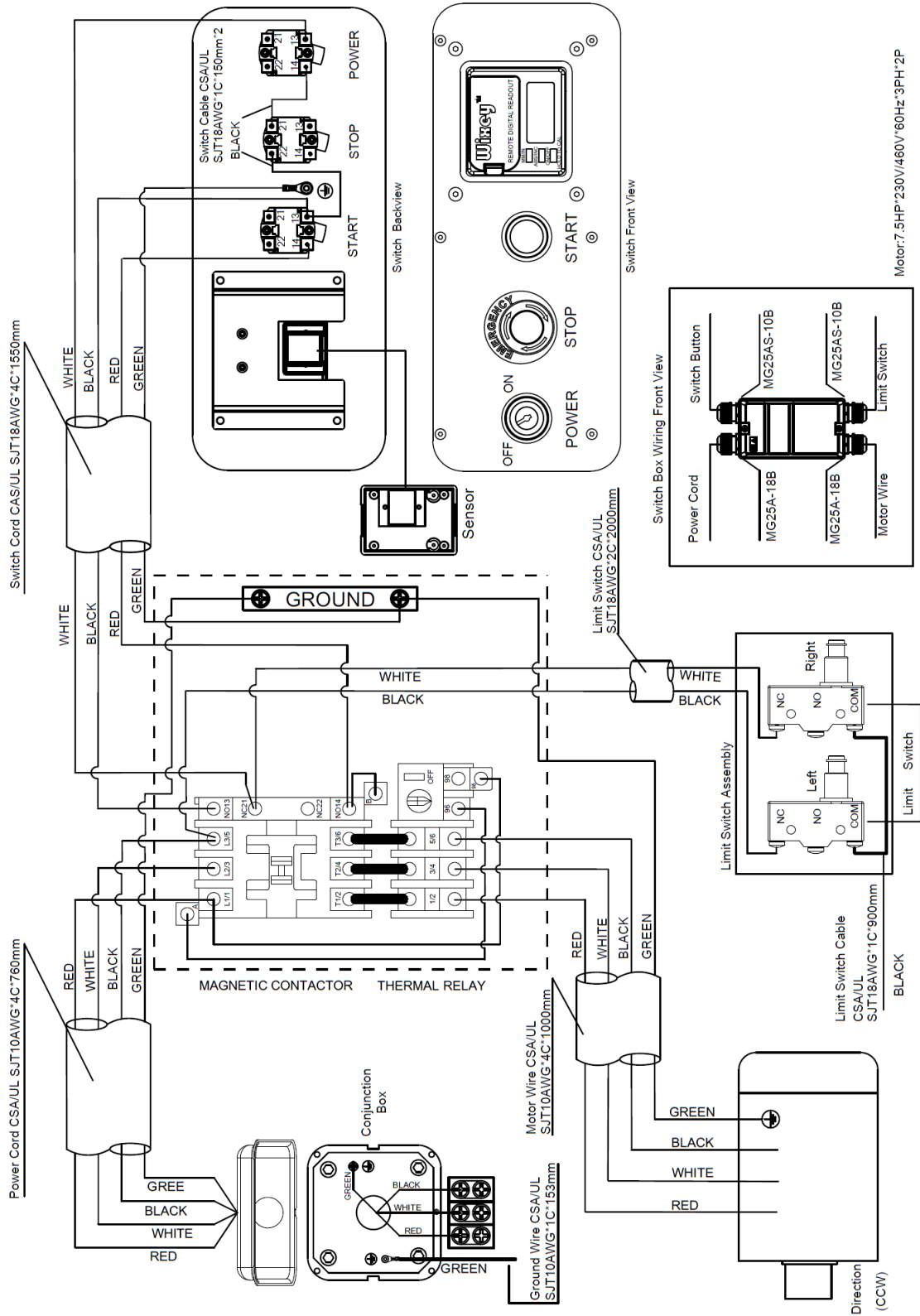

Parts List

Fence Assembly

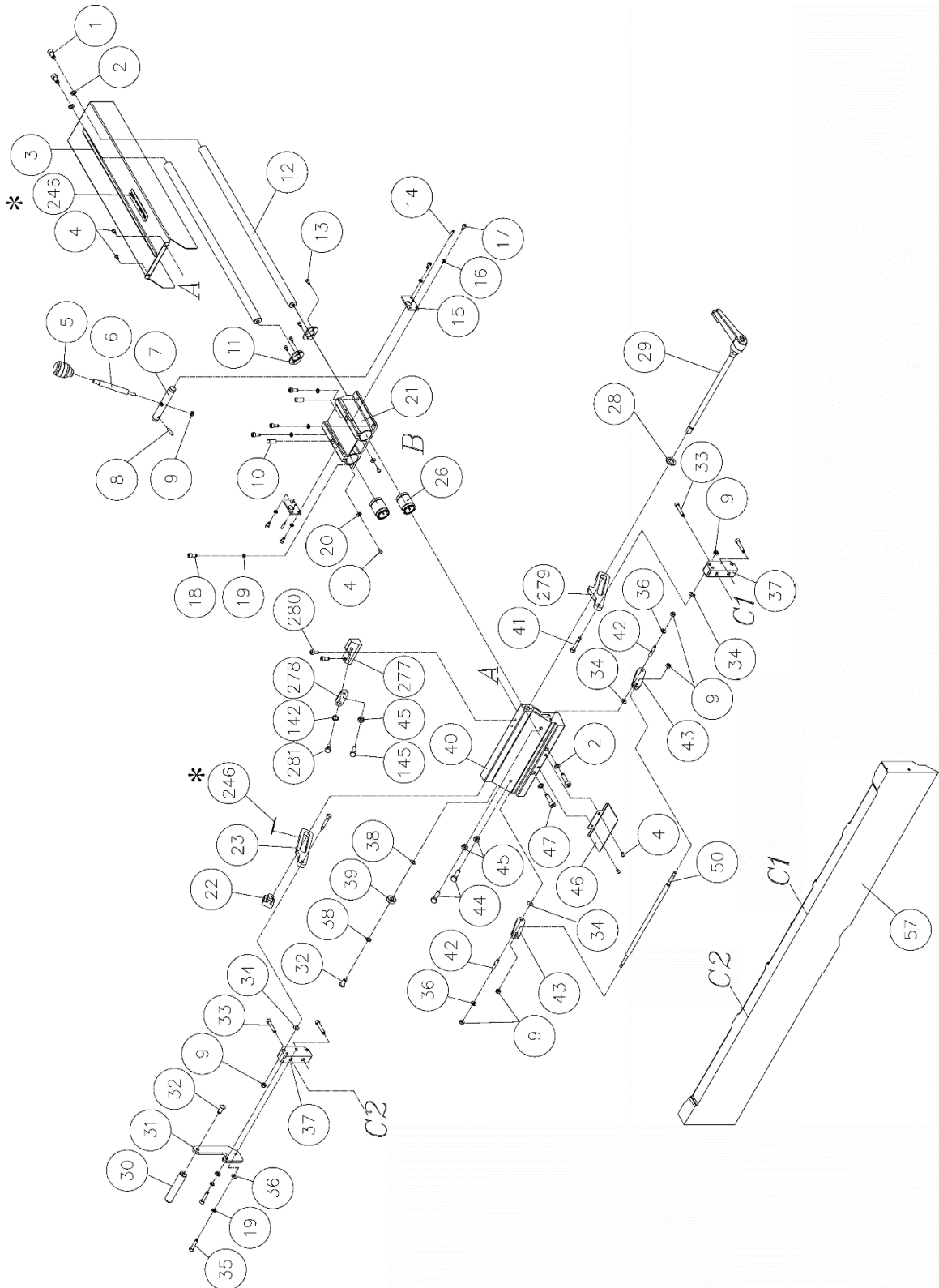
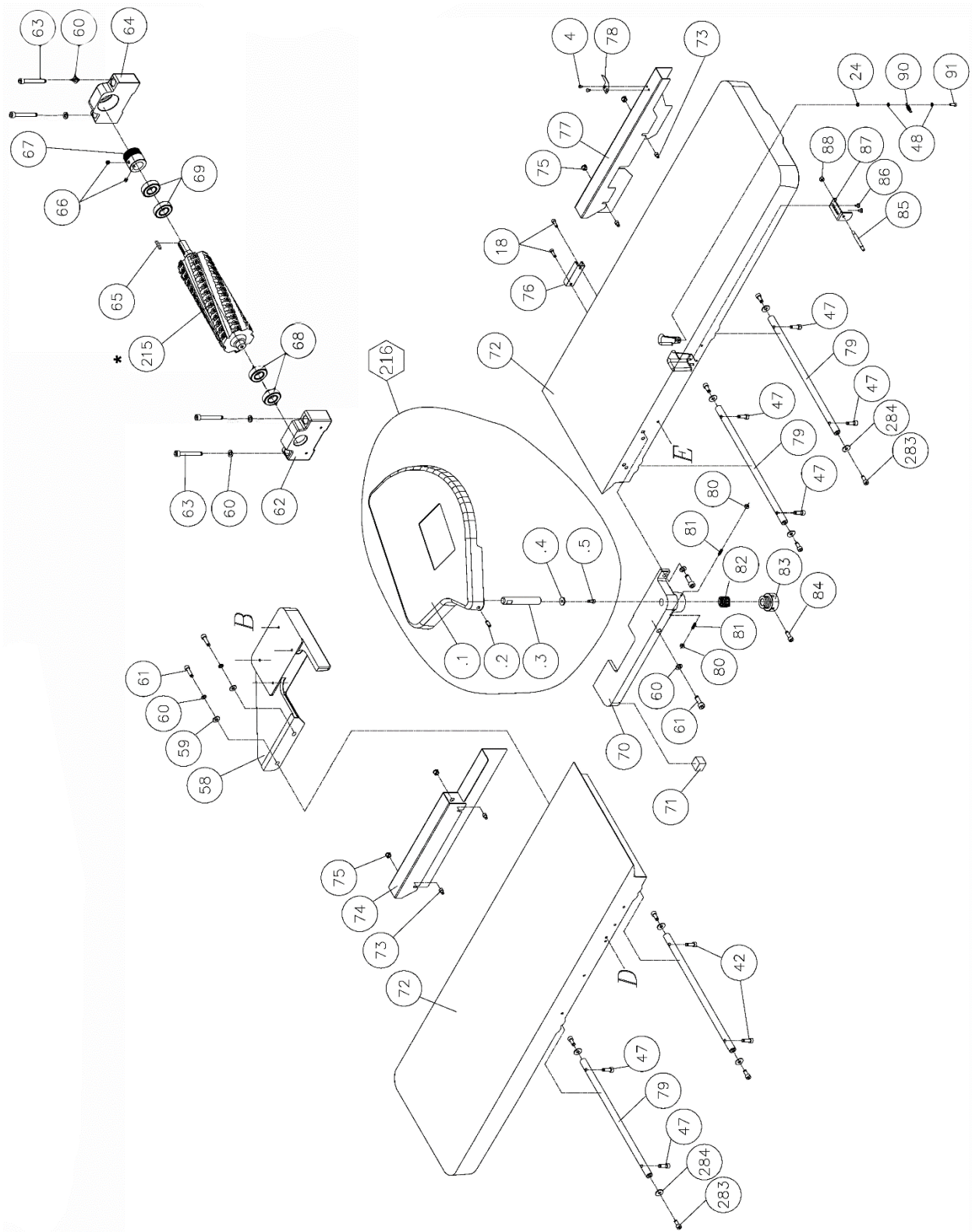
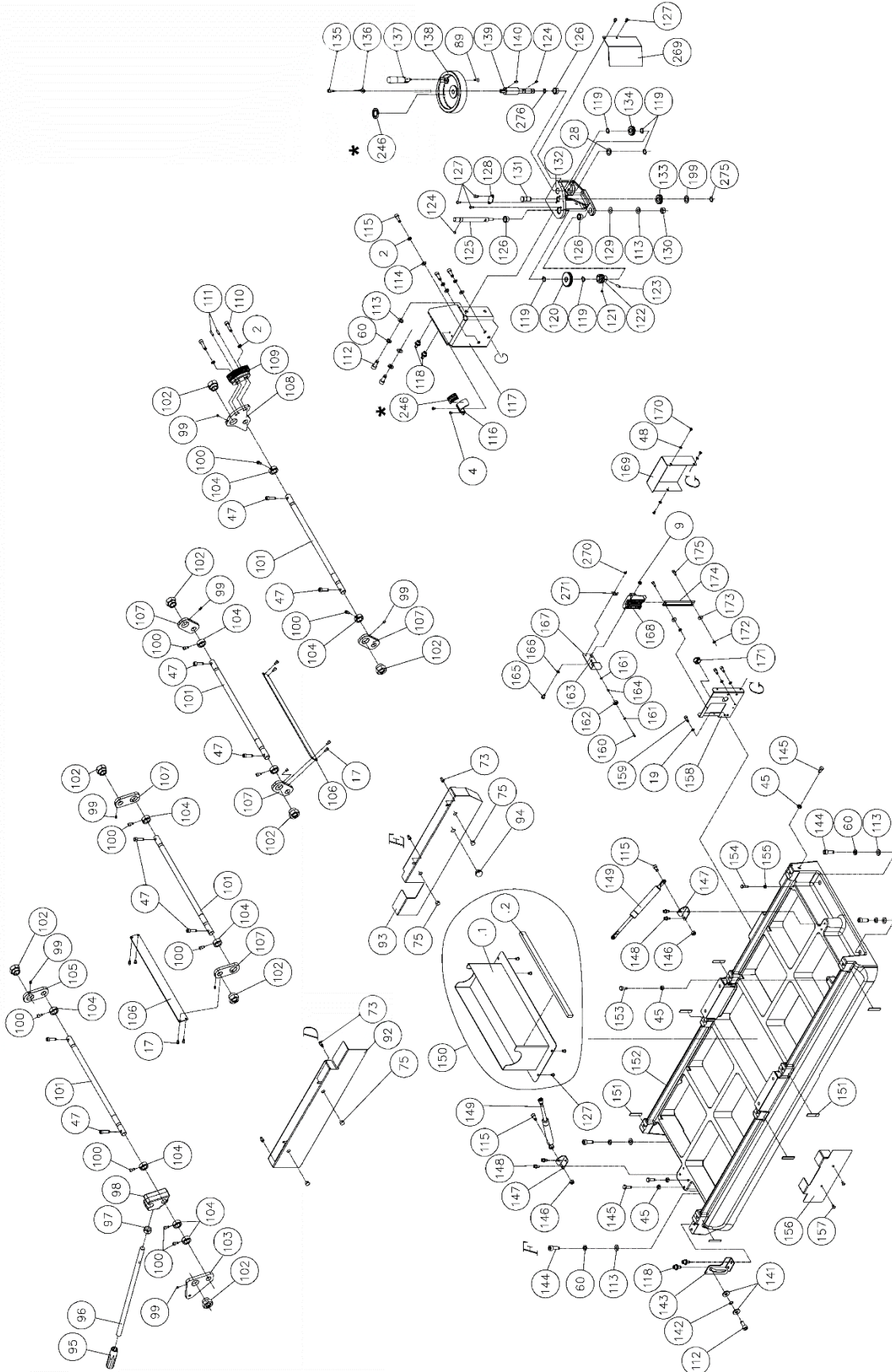
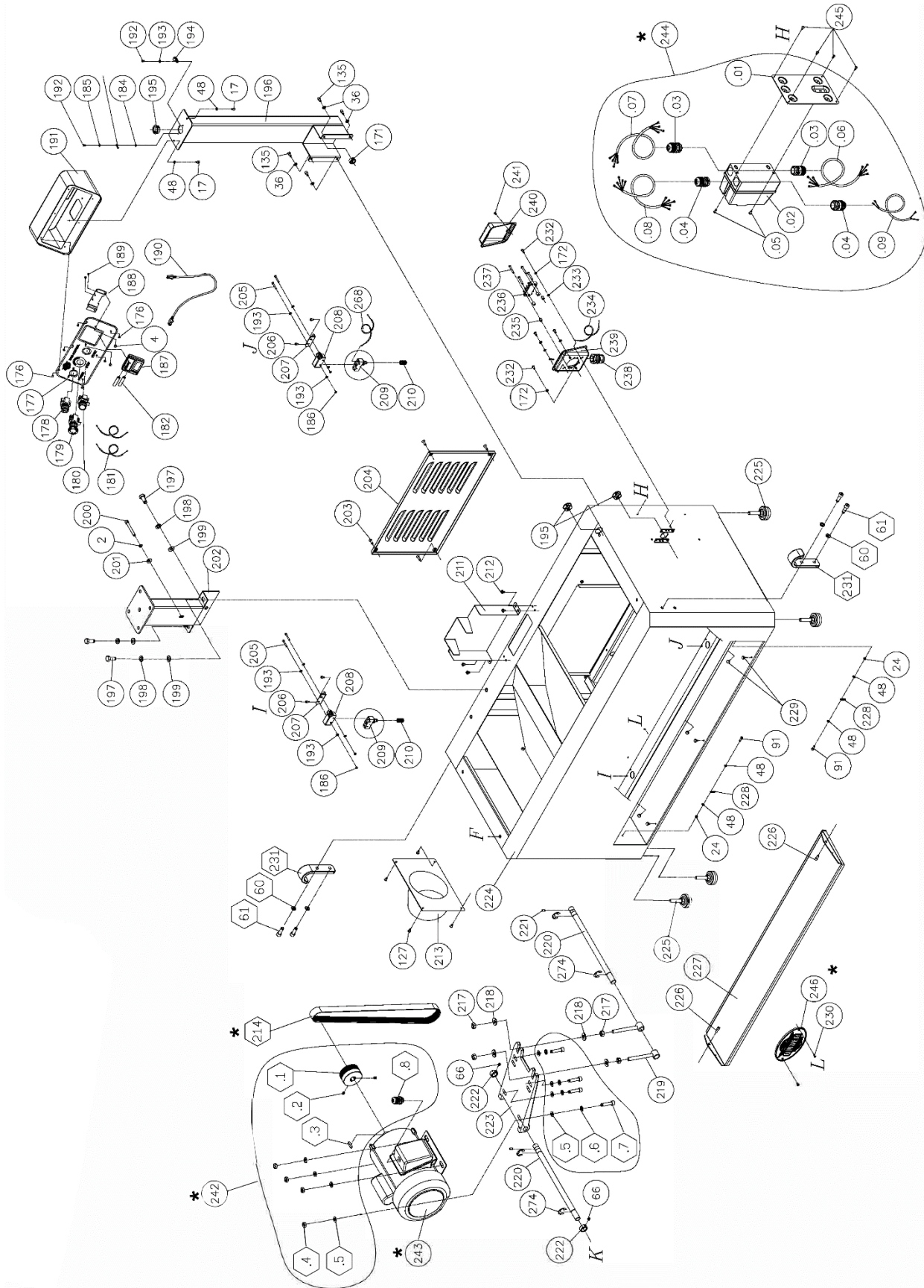

Table and Cutterhead Assembly





Motor and Cabinet



Key	Part Number	Descriptions	Specifications	QTY
1	000104-104	Cap Screw	M8*1.25P*16	2
2	006305-100	Spring Washer	8.2*13.7	10
3	174706-008	Cover		1
4	000804-101	Flat Head Cap Screw	M5*0.8P*8	12
5	250683-615	Knob		1
6	361438-904	Rod		1
7	361439-902	Axis		1
8	011003-104	Spring Pin	5*25	1
9	008304-800	Lock Nut	M6*1.0P(10B*7H)	8
10	330066-000	Bushing		2
11	330069-000	Plate		2
12	361350-000	Rod		2
13	000101-101	Cap Screw	M4*0.7P*8	4
14	011002-110	Spring Pin	4*16	2
15	174615-904	Position Plate		2
16	006302-300	Spring Washer	5.1*9.3	4
17	000102-103	Cap Screw	M5*0.8P*10	14
18	002602-102	Cap Lock Screw	M6*1.0P*20	6
19	006303-100	Spring Washer	6.5*10.5	9
20	006001-010	Flat Washer	5.2*12*1.5t	2
21	310543-909	Fence Linear Guide Bracket		1
22	130383-903	Square Nut		1
23	381411-904	Sliding Arm		2
24	008004-100	Hex. Nut	M5*0.8P(8B*4H)	3
26	034403-001	Linear Bearing	LM20UU	2
28	006001-125	Flat Washer	15.5*25*2.5t	1
29	230432-000	Universal Handle and Shaft		1
30	361333-904	Shaft		1
31	174620-904	Fence Adjust Plate		1
32	000802-102	Flat Head Cap Screw	M8*1.25P*20	2
33	000103-110	Cap Screw	M6*1.0P*35	4
34	006004-205	Flat Washer	6.8*14*0.3t	4
35	000103-108	Cap Screw	M6*1.0P*25	2
36	006011-023	Flat Washer	6.3*13*2.0t	8
37	300119-911	Shaft Block		2
38	006001-044	Flat Washer	8.5*16*0.8t	2
39	030101-001	Ball Bearing	608-ZZ	1
40	310542-911	Fence Position Bracket		1

Key	Part Number	Descriptions	Specifications	QTY
41	381464-901	Bolt		2
42	361359-902	Stud		2
43	174622-904	Link		2
44	000003-108	Hex. Screw	M8*1.25P*40	2
45	008006-100	Hex. Nut	M8*1.25P(13B*6.5H)	7
46	174956-904	Plate		1
47	000104-110	Cap Screw	M8*1.25P*30	18
48	006001-009	Flat Washer	5.2*10*1.0t	11
50	361367-902	Link Bolt		1
57	JK0014	Fence		1
58	051396-000	Fence Base		1
59	006001-068	Flat Washer	10*20*2.0t	2
60	006307-100	Spring Washer	10.2*18.5	13
61	000105-103	Cap Screw	M10*1.5P*30	7
62	051436-902	Bearing Housing (Front)		1
63	000105-109	Cap Screw	M10*1.5P*75	4
64	051435-902	Bearing Housing (Rear)		1
65	012006-001	Key	8*8*40	1
66	001903-105	Set Lock Screw	M8*1.25P*8	4
67	381414-902	Cutterhead Pulley	9-Groove	1
68	030208-002	Ball Bearing	6204-2NS	2
69	030210-002	Ball Bearing	6206-2NS	2
70	051183-000	Rabbeting Table		1
71	200105-615	Sponge	30*30*22(L*W*H)	1
72	051434-000	Table	Infeed or Outfeed	2
73	000103-102	Cap Screw	M6*1.0P*10	8
74	174645-000	Rear Cover (Left)		1
75	042505-000	Plug	HP-13	8
76	300118-909	Position Bracket		1
77	174646-000	Rear Cover (Right)		1
78	174649-156	Scale Pointer		1
79	361348-902	Table Shaft		4
80	009004-100	Hex. Nut	1/4"-20NC(11B*5.5H)	2
81	230275-000	Set Screw	1/4"-20NC*3/4"	2
82	280165-000	Torsion Spring		1
83	380825-901	Knob		1
84	000104-708	Cap Screw	M8*1.25P*25	1
85	361336-902	Round Standoff		1
86	290028-901	Shoulder Screw		2
87	174655-902	Position Plate		1

Key	Part Number	Descriptions	Specifications	QTY
88	009103-100	Lock Nut	1/4"-20NC(11B*8H)	1
89	000702-104	Socket Flat Head Hex Screw	M6*1.0P*16	1
90	280082-000	Torsion Spring		1
91	000102-116	Cap Screw	M5*0.8P*15	3
92	174644-000	Front Cover (Left)		1
93	174643-000	Front Cover (Right)		1
94	230156-615	Knob		1
95	250496-615	Handle		1
96	361300-902	Rod		1
97	008011-100	Hex. Nut	M16*2.0P(24B*13H)	1
98	051401-902	Elevation Bracket		1
99	001902-102	Set Lock Screw	M6*1.0P*8	8
100	002602-101	Cap Lock Screw	M6*1.0P*12	10
101	361349-902	Shaft		4
102	381392-902	Eccentric Bushing		8
103	174513-904	Shaft Plate		1
104	381393-902	Bushing		10
105	174512-904	Shaft Plate		1
106	174705-000	Plate		2
107	174650-902	Shaft Plate		5
108	174515-904	Shaft Plate		1
109	070070-902	Toothed Bracket		1
110	000104-111	Cap Screw	M8*1.25P*35	2
111	011103-103	Pin	5.0*20	2
112	000105-102	Cap Screw	M10*1.5P*25	3
113	006001-075	Flat Washer	10.3*22*2.0t	7
114	006001-038	Flat Washer	8*16*1.6t	3
115	000104-106	Cap Screw	M8*1.25P*20	5
116	174656-904	Scale Seat		1
117	174516-902	Position Bracket		1
118	001501-101	Cap w/Spring Washer/Flat Washer	M8*1.25P*20/8.2*15.4/8.5*19*2t	4
119	010006-000	S Ring	STW-15	5
120	320398-000	Gear	50T	1
121	000203-101	Set Screw	M6*1.0P*6	1
122	361301-902	Worm Gear		1
123	011003-114	Spring Pin	5*20	1
124	012003-001	Key	5*5*8	2
125	361302-902	Position Shaft		1
126	330067-000	Bushing		3
127	000801-101	Flat Head Cap Screw	M6*1.0P*10	13

Key	Part Number	Descriptions	Specifications	QTY
128	174518-902	Plate		1
129	006004-070	Flat Washer	10*22*0.8t	1
130	008308-100	Lock Nut	M10*1.5P(17B*12H)	1
131	381469-902	Position Bolt		1
132	051407-902	Bracket		1
133	320413-000	Gear	30T	1
134	320397-000	Gear	30T	1
135	000103-103	Cap Screw	M6*1.0P*12	5
136	006001-025	Flat Washer	6.4*16*1.0t	1
137	230284-000	Handle		1
138	240092-008	Handwheel		1
139	361395-902	Handwheel Shaft		1
140	012002-006	Key	4*4*16	1
141	006001-071	Flat Washer	10*25*3.0t	2
142	006703-100	Wavy Washer	WW-10	2
143	174514-902	Outfeed Table Lock Plate		1
144	000105-105	Cap Screw	M10*1.5P*40	4
145	000003-105	Hex. Screw	M8*1.25P*25	4
146	008306-100	Lock Nut	M8*1.25P(13B*9H)	2
147	174653-902	Bracket		2
148	001502-102	Cap w/Spring Washer/Flat Washer	M6*1.0P*16/6.5*10.5/6.3*13*1.0t	4
149	660292-000	Hydraulic Cylinder		2
150	924706-000	Dust Cover Assembly		1
150.1	174704-008	Dust Cover		1
150.2	200107-615	Sponge		1
151	200024-615	Vibration Absorbing Pad		7
152	051433-000	Base		1
153	000003-106	Hex. Screw	M8*1.25P*30	1
154	000002-106	Hex. Screw	M6*1.0P*30	1
155	008005-100	Hex. Nut	M6*1.0P(10B*5H)	1
156	174647-000	Cutterhead Front Cover		1
157	000801-104	Flat Head Cap Screw	M6*1.0P*20	2
158	174612-008	Digital Readout Position Plate		1
159	000103-106	Cap Screw	M6*1.0P*16	3
160	000301-204	Phillips Screw	M3*0.5P*15	1
161	006002-139	Flat Washer	3*8*1.0t	2
162	030127-001	Ball Bearing	606-ZZ	1
163	008315-200	Lock Nut	M3*0.5P(5.5B*4H)	1
164	360906-902	Bushing		1

Key	Part Number	Descriptions	Specifications	QTY
165	000002-101	Hex. Screw	M6*1.0P*12	1
166	006001-155	Flat Washer	6*12*1t	1
167	174652-000	Bracket		1
168	491128-000	Sensor	WR5501	1
169	174611-008	Cover		1
170	000102-101	Cap Screw	M5*0.8P*6	3
171	021801-000	Snap Bushing	NB-1722	2
172	006001-131	Flat Washer	5.3*10*2.0t	6
173	006001-181	Flat Washer	5*16*3.0t	2
174	950785-000	Magnetic Strip Assembly	Depth: 3/4"	1
175	002603-702	Cap Lock Screw	M5*0.8P*16	2
176	000805-101	Flat Head Cap Screw	M4*0.7P*6	6
177	574956-000	Switch Panel		1
178	490019-000	Key Switch		1
179	490039-000	Stop Switch		1
180	490040-000	Start Switch		1
181	471037-083	CSA Cable	SJT18AWG*1C*150mm	2
182		Battery (Local Purchase)	AAA	2
184	006501-100	Toothed Washer	4.3*8.5(BW-4)	1
185	006002-200	Flat Washer	4.3*8*0.8t	1
186	008002-200	Hex. Nut	M4*0.7P(7B*3.2H)	4
187	491210-000	Digital Readout	WR5502CT(Wixey)(Backlit)	1
188	174750-000	Position Bracket		1
189	001101-205	Self-Tapping Screw	M3*1.06P*6	2
190	730139-001	Transmission Cable	Cat 5E* RJ-45-CT-A *2000mm	1
191	174770-000	Switch Box		1
192	000302-102	Phillips Screw	M4*0.7P*8	2
193	006001-001	Flat Washer	4.3*10*1.0t	9
194	021103-100	Zip Tie	ACC-3-B	1
195	021802-000	Snap Bushing	NB-2430	3
196	924571-000	Switch Pedestal Assembly		1
197	000005-111	Hex. Screw	M12*1.75P*30	3
198	006308-100	Spring Washer	12.2*21.6	3
199	006001-136	Flat Washer	12.2*23*2.0t	4
200	000104-117	Cap Screw	M8*1.25P*70	1
201	006001-054	Flat Washer	8.5*20*2.0t	1
202	381391-308	Bracket		1
203	000403-104	Pan Phillips Screw	M6*1.0P*20	4
204	170479-000	Rear Access Panel		1
205	000101-110	Cap Screw	M4*0.7*30	4
206	000102-102	Cap Screw	M5*0.8P*8	4

Key	Part Number	Descriptions	Specifications	QTY
207	174651-902	Bracket		2
208	490229-615	Limited Switch Cover	KSSCB-2	2
209	491101-000	Limited Switch	MJ2-1307	2
210	280274-000	Spring		2
211	174642-000	Belt Guard		1
212	001603-102	Phillips Head Screw w/Flat Washer	M6*1.0P*10/6*13.2*1.0t	4
213	174641-008	Dust Port		1
214	014343-000	V-Belt	490J-9	1
215	JP02-12	Cutterhead Assembly		1
	040710-000	Torx Screwdriver	T-25	2
	038201-101	Torx Screw	#10-32NF*1/2"	76
	P-15mm 4S	Inserts Sold in Packs of 10	15*15*2.5t	76
216	924705-000	Cutterhead Guard Assembly		1
216.1	300138-000	Cutterhead Guard		1
216.2	000204-103	Set Screw	M8*1.25P*12	1
216.3	361437-901	Guard Pivot Shaft		1
216.4	006001-021	Flat Washer	6.2*22*3t	1
216.5	000103-105	Cap Screw	M6*1.0P*15	1
217	008009-100	Hex. Nut	M12*1.75P(19B*10H)	4
218	006001-091	Flat Washer	13*28*3.0t	4
219	380249-901	Adjusting Shaft Assembly		2
220	361303-902	Supporting Shaft		2
221	001902-105	Set Lock Screw	M6*1.0P*12	2
222	190074-901	Spacer		2
223	050321-008	Motor Mounting Plate		1
224	174703-000	Stand		1
225	230403-000	Foot		4
226	000103-120	Cap Screw	M6*1.0P*15	2
227	174762-156	Emergency Stop Foot Switch		1
228	280050-000	Spring		2
229	340007-615	Rubber Packing		6
230	000401-104	Pan Phillips Screw	M4*0.7P*10	2
231	170638-156	Lifting Hook		2
232	000303-104	Phillips Screw	M5*0.8P*12	4
233	006502-300	Toothed Washer	5.3*10(BW-5)	2
234	471008-001	CSA Cable	10AWG*1C*153mm	1
235	250573-615	Bushing		4
236	490336-000	Terminal Socket	HD-30-A3(600V/40A)	1
237	000303-109	Phillips Screw	M5*0.8P*35	4
238	023701-015	Strain Relief	MGB25-18B w/nut	1

Key	Part Number	Descriptions	Specifications	QTY
239	491116-008	Junction Box Lower Cover		1
240	490124-008	Junction Box Upper Cover		1
241	003303-102	Phillips Screw	3/16"-24NC*1/4"	1
242.1	381412-902	Motor Pulley	9-Groove	1
242.2	001903-101	Set Lock Screw	M8*1.25P*25	2
242.3	013003-001	Key	1/4"*1/4"*1-1/2"	1
242.4	008007-100	Hex. Nut	M10*1.5P(17B*8H)	4
242.5	006001-068	Flat Washer	10*20*2.0t	8
242.6	006307-100	Spring Washer	10.2*18.5	4
242.7	000105-105	Cap Screw	M10*1.5P*40	4
242.8	023701-015	Strain Relief	MGB25-18B w/nut	1
243	L3608T	Baldor Motor	5HP 1PH 220V	1
	EM3616T	Baldor Motor	7.5HP 3Ph 220/440V	1
244	938014-000	Magnetic Switch Assembly		1
244.1	170977-901	Switch Plate		1
244.2	490270-000	220V Magnetic Contactor	MA-18 (5HP 1Ph or 7.5HP 3Ph)	1
NS	490296-000	220V Overload RA-20	12-18A (5HP 1Ph or 7.5HP 3Ph)	1
244.3	021313-000	Strain Relief	MG25A-18B no nut	2
244.4	021377-000	Strain Relief	MG25AS-10B no nut	2
244.5	000303-104	Phillips Screw	M5*0.8P*12	2
244.6	474005-015	CSA Cable	SJT 10AWG*4C*1000mm	1
244.7	474005-016	CSA Cable	SJT 10AWG*4C*760mm	1
244.8	474001-013	CSA Cable	SJT 18AWG*4C*1550mm	1
244.9	472001-050	CSA Cable	SJT 18AWG*2C*2000mm	1
Note: 440V 3Phase operation requires special components, contact Oliver Machinery				
NS	490716-000	MA-18(440V)	MA-18(440V)	
NS	490234-000	RA-20 (8-10-12)	RA-20 (8-10-12)	
245	000804-103	Flat Head Cap Screw	M5*0.8P*10	4
246		Label	Advise content/location to order	
248	250035-629	Push Blocks		2
249		Hex. Wrench	5mm (Local Purchase)	1
250		Hex. Wrench	6mm (Local Purchase)	1
251		Hex. Wrench	8mm (Local Purchase)	1
252		Double End Open Wrench	17mm x 19mm (Local Purchase)	1
268	471037-095	CSA Cable	SJT 18AWG*1C*900mm	1
269	174949-904	Cover		1
270	000303-201	Phillips Screw	M5*0.8P*6	1
271	174953-000	Stop Block		1
274	010202-000	E-Ring	ETW-17	4
275	010003-000	S-Ring	STW-12	1

Key	Part Number	Descriptions	Specifications	QTY
276	043322-000	O-Ring P Type	P11	1
277	310589-909	Block		1
278	175163-901	Block		1
279	381493-904	Position Bracket		1
280	000103-105	Cap Screw	M6*1.0P*15	2
281	290003-901	Screw		1
283	002601-102	Cap Lock Screw	M8*1.25P*20	8
284	006001-056	Flat Washer	8.5*23*2.0t	8

Spare Parts

Part Number	Descriptions	Specifications	QTY
P-15mm 4S	Insert (Sold in Box Of 10)		10
038201-101	Torx Screw	#10-32UNF*1/2"	10

Warranty and Service

Oliver Machinery makes every effort to assure that its equipment meets the highest possible standards of quality and durability. All products sold by Oliver Machinery are warranted to the original customer to be free from defects for a period of two (2) years on all parts excluding electronics and motors which are warranted for one (1) year from the date of shipment. Oliver Machinery's obligation under this warranty shall be exclusively limited to repairing or replacing products or parts or components, at its sole option, determined by Oliver Machinery to be defective. Oliver Machinery shall not be required to provide other form of indemnity or compensation including but not limited to compensatory damages.

This warranty does not apply to defects due to direct or indirect misuse, abuse, negligence, accidents, unauthorized repairs, alternation outside our facilities, lack of maintenance, acts of nature, or items that would normally be consumed or require replacement due to normal wear and tear.

OTHER TERMS

To obtain and exercise the warranty right, please call 800-559-5065 or fill out warranty request form online at www.olivermachinery.net.

Warranty parts are shipped via Parcel or Ground. Additional charges will occur and charge to customers if express shipping is required.

DISCLAIMER

Under no circumstances shall Oliver Machinery be liable for death, personal or property injury, or damages arising from the use of its products.

Oliver Machinery reserves the right to make changes without prior notice to its products to improve function or performance or design.

FOR MORE INFORMATION

If you need assistance or have questions beyond what is covered in the scope of this warranty information, please call 800-559-5065 or email us at info@olivermachinery.net.

Appendix

US Standard – Metric Conversion Chart

Fractions	Decimal In.	Millimeters
1/64	.0156	.396
1/32	.0312	.793
3/64	.0469	1.190
1/16	.0625	1.587
5/64	.0781	1.984
3/32	.0937	2.381
7/64	.1094	2.778
1/8	.125	3.175
9/64	.1406	3.571
5/32	.1562	3.968
11/64	.1719	4.365
3/16	.1875	4.762
13/64	.2031	5.159
7/32	.2187	5.556
15/64	.2344	5.953
1/4	.25	6.350
17/64	.2656	6.746
9/32	.2812	7.143
19/64	.2969	7.540
5/16	.3125	7.937
21/64	.3281	8.334
11/32	.3437	8.731
23/64	.3594	9.128
3/8	.375	9.525
25/64	.3906	9.921
13/32	.4062	10.318
27/64	.4219	10.715
7/16	.4375	11.112
29/64	.4531	11.509
15/32	.4687	11.906
31/64	.4844	12.303
1/2	.5	12.700

Fractions	Decimals In.	Millimeters
33/64	.5156	13.096
17/32	.5312	13.493
35/64	.5469	13.890
9/16	.5625	14.287
37/64	.5781	14.684
19/32	.5937	15.081
39/64	.6094	15.478
5/8	.625	15.875
41/64	.6406	16.271
21/32	.6562	16.668
43/64	.6719	17.065
11/16	.6875	17.462
45/64	.7031	17.859
23/32	.7187	18.256
47/64	.7344	18.653
3/4	.75	19.050
49/64	.7656	19.446
25/32	.7812	19.843
51/64	.7969	20.240
13/16	.8125	20.637
53/64	.8281	21.034
27/32	.8437	21.431
55/64	.8594	21.828
7/8	.875	22.225
57/64	.8906	22.621
29/32	.9062	23.018
59/64	.9219	23.415
15/16	.9375	23.812
61/64	.9531	24.209
31/32	.9687	24.606
63/64	.9844	25.003
1.0	1.	25.400



Oliver Machinery is always adding new Industrial Woodworking products to the line.

For complete, up-to-date product information, visit us online at:

WWW.OLIVERMACHINERY.NET

or call toll free 1-800-559-5065

**** SAVE THIS MANUAL FOR FUTURE REFERENCES. ****