

Jointer

Model 4235

Owner's Manual

For Models Manufactured Since 05/2019



Oliver Machinery
1-800-559-5065
921 Thomas Ave SW,
Renton, WA 98057

info@olivermachinery.net
WWW.OLIVERMACHINERY.NET

Stock Number: 4235.201
Manual Version: 2.0.1



READ AND UNDERSTAND ALL INSTRUCTIONS IN THIS MANUAL BEFORE ATTEMPTING TO ASSEMBLE OR OPERATE THE MACHINE.

FOLLOW THE INSTRUCTIONS AND THINK SAFETY!

THE OWNER OF THIS MACHINE IS SOLELY RESPONSIBLE FOR THE SAFETY OF ANYONE USING THIS MACHINE. SUCH RESPONSIBILITY INCLUDES BUT NOT LIMITED TO:

- **PROPER ASSEMBLY, OPERATION, INSPECTION, MAINTENANCE, AND RELOCATION OF THE MACHINE.**
- **PROPER TRAINING FOR THE OPERATORS AND ENSURES THIS MANUAL IS AVAILABLE AT ALL TIMES.**
- **USAGE AUTHORIZATION.**
- **USAGE OF SAFETY AND PROTECTION DEVICE.**

OLIVER MACHINERY DISCLAIMS ANY LIABILITY FOR MACHINES THAT HAVE BEEN ALTERED OR ABUSED. OLIVER MACHINERY RESERVES THE RIGHT TO EFFECT AT ANY TIME, WITHOUT PRIOR NOTICE, THOSE ALTERATIONS TO PARTS, FITTINGS, AND ACCESSORY EQUIPMENT WHICH THEY MAY DEEM NECESSARY FOR ANY REASON WHATSOEVER.

**** SAVE THIS MANUAL FOR FUTURE REFERENCES. ****

PROP 65 NOTICE

WARNING: Drilling, sawing, sanding, or machining wood products can expose you to wood dust, and/or other chemicals that are known to the State of California to cause cancer, birth defects, or other reproductive harm.

Some examples of these chemicals are:

- Lead from lead-based paints.
- Crystalline silica from bricks, cement, and other masonry products.
- Arsenic and chromium from chemically treated lumber.

Avoid inhaling wood dust and other harmful chemicals. Use a dust mask and/or other safety devices for personal protection.

For more information go to <http://www.P65Warnings.ca.gov/wood>

Table of Contents

Introduction	5	Surface Planing	29
Specifications	6	Edge Jointing	31
Identification	9	Beveling	31
Safety	11	Rabbet Cutting	32
General Safety Guidelines.....	11	Common Cutting Problems	33
Safety Guidelines Specific to Jointer.....	12	Snipe.....	33
Electricals	14	Chipping	33
Minimum Circuit Size Required for Model		Fuzzy Grain	33
4235 Jointer	14	Accessories	34
Grounding.....	14	Maintenance	35
Electrical Wiring	14	Maintenance Schedule	35
Setup	16	Inspect / Adjust Jointer Tables.....	36
Shop Preparation.....	16	Inspect Outfeed Table Height	36
Space Requirement.....	16	Adjust Outfeed Table Height.....	36
Load Limits	16	Inspect Outfeed Table Parallelism	37
Electricals	16	Inspect Infeed Table.....	37
Lighting.....	16	Adjust Table Parallelism/Coplanarity.....	38
Safety Labels	16	Infeed Table Adjustments	40
Dust Collection	16	Infeed Table Depth Stop Adjustments	41
Receiving.....	17	Rotate / Replace Cutter Inserts	42
Cleaning	19	Adjust Fence Positive Stops	43
Assembly	20	Adjust Belt Tension.....	45
Dust Collection	22	Align Belt Pulleys.....	46
Controls and Components	23	Troubleshooting	47
Powerswitch	23	Mechanical / Electrical Issues.....	47
Infeed Table Adjustment	23	Operation / Quality-Related Issues	48
Infeed Table Depth Stop Knob	23	Wiring Diagram	50
Outfeed Table Height Adjustment.....	24	Parts List	51
Fence	25	Maintenance Record	60
Test Run	26	Notes	61
Operation	27	Warranty and Service	62
Preparation	27	Appendix	63
Inspect Wood Grain.....	28	US Standard – Metric Conversion Chart.....	63
Squaring Stock.....	28		

Introduction

Thank you for choosing Oliver! This manual contains important information on how to safely set up, operate, and maintain this machine. Please take the time to read through this manual, and make sure you understand all instructions.

While this manual may provide tips on optimizing the result of your workpiece, the manual is not intended as a substitute for formal woodworking training. If you need to know how to safely complete a woodworking task, please consult knowledgeable and qualified sources before proceeding further.

We made every effort to keep this manual up-to-date. Instructions, specifications, drawings, and photographs in this manual should match the machine delivered. If you find any differences, or anything that seems confusing in this manual, or some instructions are not available, please check our website for an updated version:

WWW.OLIVERMACHINERY.NET/MANUALS

Alternatively, you can contact our technical support for help:

1-800-559-5065

Before calling, please note down the manufacture date and the serial number of the machine. You can find the information on a nameplate located on the back of the machine. This information is needed to provide proper technical support, and to determine if an updated manual is available for your machine.

Please let us know how well this manual serves you. If you have any suggestions, please call the number above or email us at:

info@olivermachinery.net

We love to hear from our customers and make improvements.

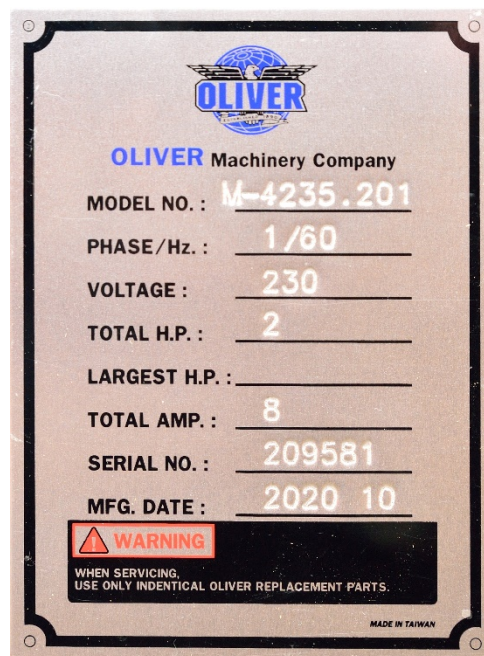

Specifications

Quick View

Model	4235 Jointer
Stock Number	4235.201
Motor	TEFC Induction Motor 2HP, 230V, 1Ph
Jointer Size	8"
Max. Depth of Cut (Jointing)	1/8"
Max. Depth of Cut (Rabbeting)	1/2"
Bevel Joining	45°-135° (With quick stops at 45°, 90°, 135°)
Dimensions	72-1/4"(L) x 25"(W) x 39-1/2"(H)
Footprint	39-1/4"(L) x 14-1/2"(W)
Fully Assembled Weight	352 lbs.
Warranty	1 Year (Motor and electronics) 2 Years (All other parts)

Product Dimensions

Jointer Fully Assembled	72-1/4"(L) x 25"(W) x 39-1/2"(H)
Footprint	39-1/4"(L) x 14-1/2"(W)
Fully Assembled Weight	352 lbs.

Shipment Info

Type	Wood crate with skid
Content	Jointer with included accessories
Dimensions	75-3/4"(L) x 25-1/4"(W) x 42"(H)
Weight	489 lbs.
Approximate Setup Time	45 minutes
Must Ship Upright	YES
Stackable	NO

Electricals

Power Requirement	230V, 1Ph, 60Hz
Full Load Current Rating	8A
Recommended circuit size	15A
Power Switch Type	Magnetic paddle switch
Connection Type	NEMA 6-15 Plug with 7' 14 AWG Cord

Motor

Motor Type	TEFC Induction Motor
Horsepower	2HP
Speed	3450 RPM
Efficiency	82.8%
Power Factor	95.4%
Power Transfer Mechanism	Poly V-belt and pulleys
Bearing type	Permanently sealed ball bearing

Jointer Capacity and Performance

Maximum Stock Width	8"
Maximum Depth of Cut for Jointing	1/8"
Maximum Depth of Cut for Rabbeting	1/2"
Minimum Stock Thickness	3/4"
Minimum Stock Length	10"

Fence

Dimensions	38-1/8" (L) x 4-3/4" (H)
Fence Tilt	45° - 135°
Fence Stops	45°, 90°, 135°
Material	Precision ground cast iron

Cutterhead

Cutterhead Type	Helical
Cutterhead Diameter	3-5/64"
Cutterhead Speed	5500 RPM
Number of Cutter Inserts	36
Number of Rows of Cutter Inserts	4
Cutter Insert Type	Four-sided, indexable carbide
Cutter Insert Diameters	15mm x 15mm x 2.5mm
Cutter Blade Angle	30 degree
Cutter Insert Screw Tensioning Torque	52-60 lb-in

Table

Table Dimensions	72-1/4"(L) x 8"(W)
Table Height Above Ground	31-1/8"
Table Lifting / Adjustment Mechanism	Parallelogram
Material	Precision ground cast iron

Measurements

Measurement Unit	Inch
Measurement Devices	Depth Scale

Safety

Number of Dust Ports	1
Dust Port Size	4"
Minimum CFM Required	500 CFM
Sound Rating @ 2' distance	83 dB

Others

Serial Number Location	On the back of the machine.
Spare Parts Included	Five cutter inserts and compatible Torx screws.
Certification	CSA 175370
Country of Origin	Taiwan

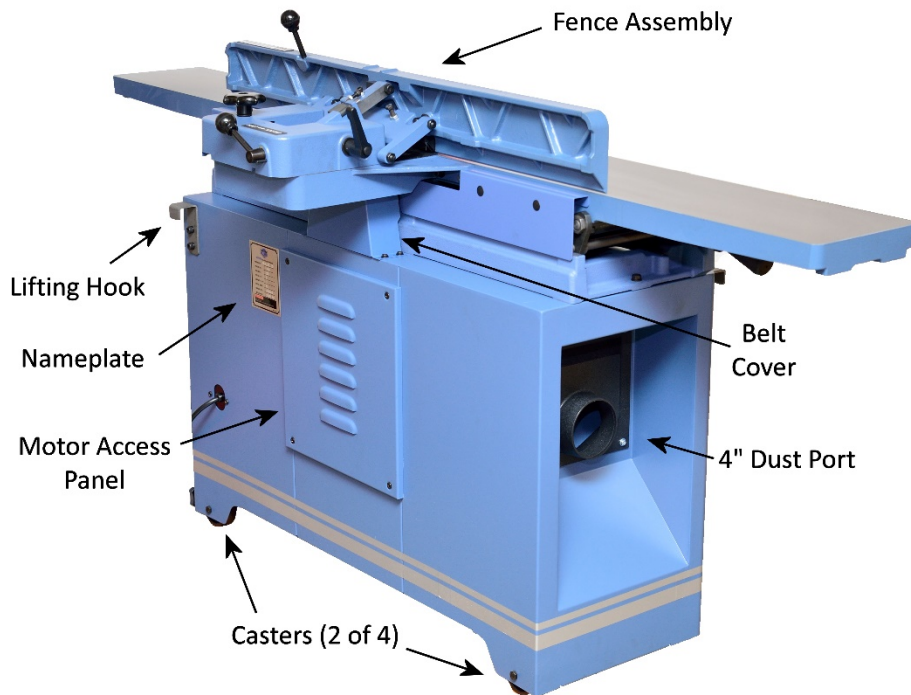
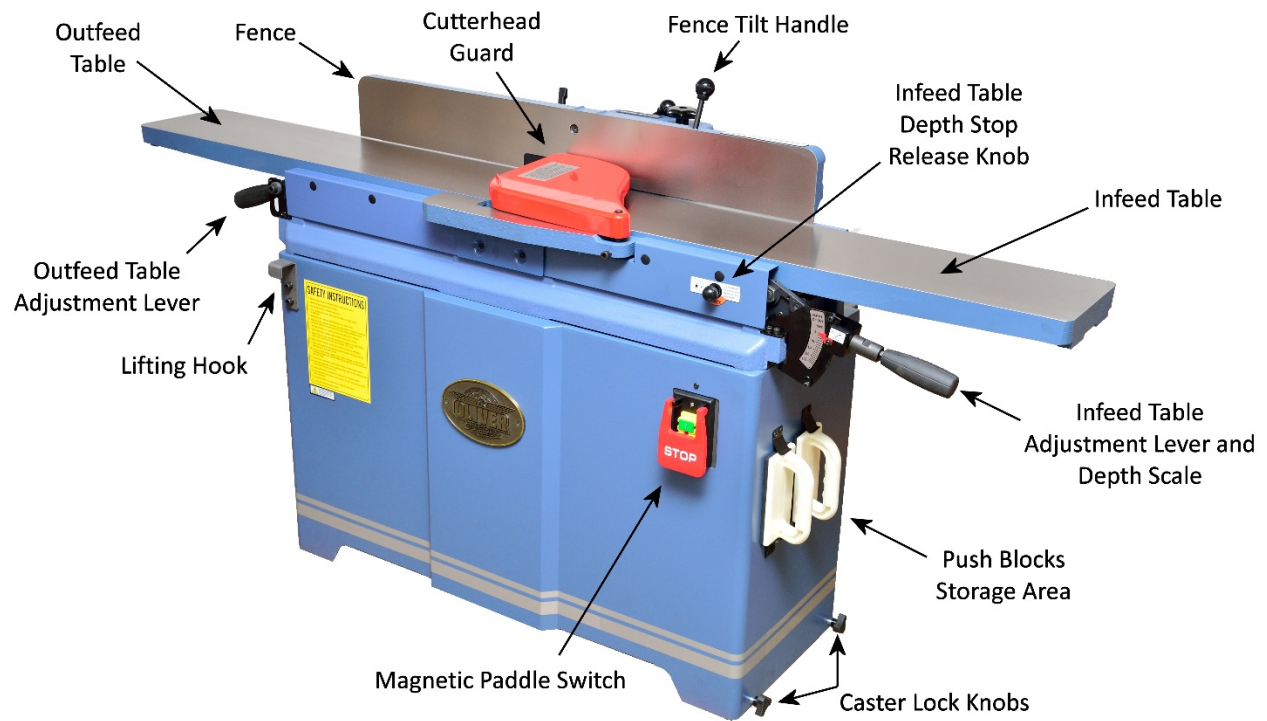

Identification

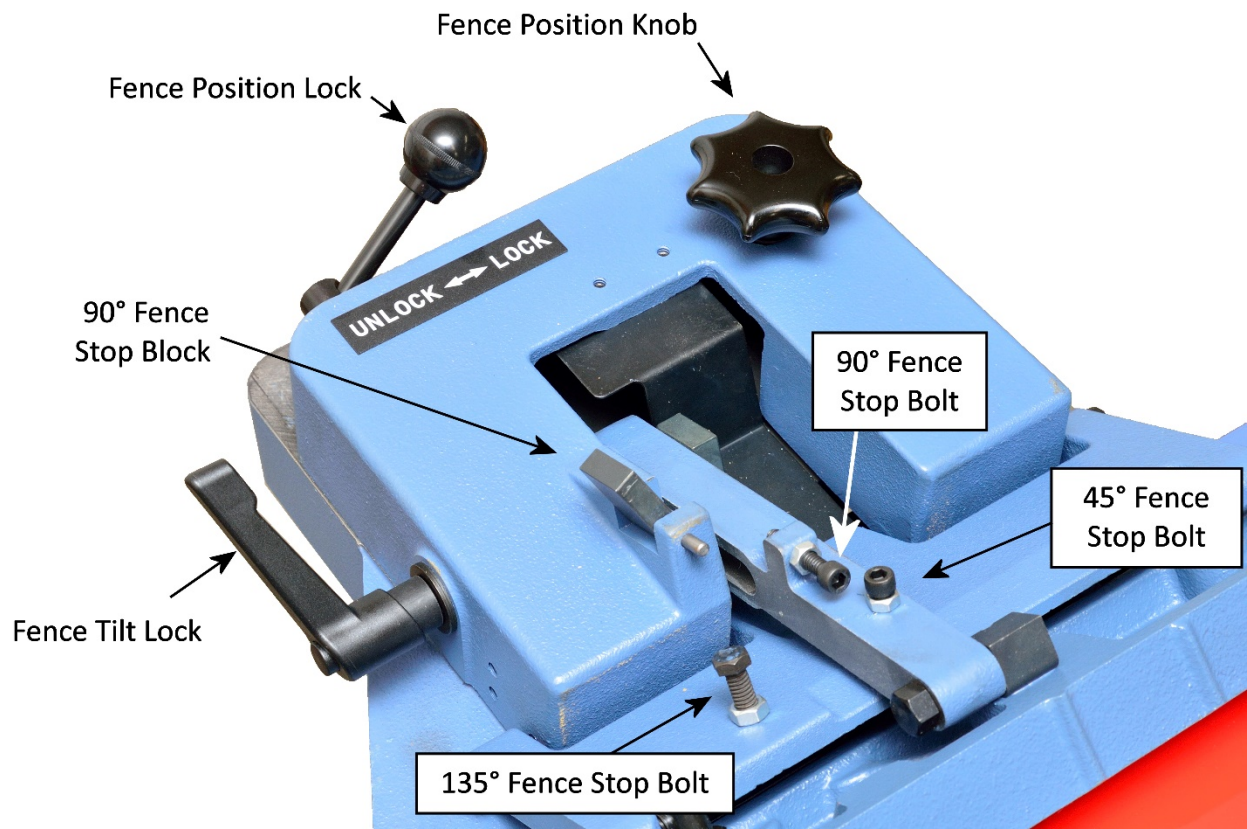



Safety

Oliver Machinery has made every attempt to provide a safe, reliable, easy-to-use piece of machinery. Safety, however, is ultimately depending on the individual machine operator. **Before operating this machine, please become familiar with the following safety labels and guidelines.**

 DANGER	This indicates an imminently hazardous situation which, if not avoided, WILL cause death or serious injury.
 WARNING	This means if the warning is not taken seriously, it CAN cause death or serious injury.
 CAUTION	This means if the precaution is not taken, it MAY cause minor or moderate injury.
IMPORTANT	This is a tip for properly operating the machine to avoid machine damage.

General Safety Guidelines

1. **FAMILIARIZE** yourself with all safety instructions found in this manual. Know the limitations and hazards associated with this machine. Do not operate/service this machine until you are properly trained.
2. **ELECTRICAL GROUNDING**, when done properly, reduce the risk of electrocution, shocks, and fire. Make certain that the machine frame is electrically grounded and that a ground lead is included in the incoming electrical service. In cases where a cord and a plug are used, make certain that the grounding plug connects to a suitable ground. Follow the grounding procedure indicated in the electrical code of your area.
3. **DISCONNECT** the machine from power before performing any service, maintenance, or adjustments. A machine under repair should be RED TAGGED to show it should not be used until the repair is complete.
4. **EYE PROTECTION**: Always wear an approved safety face shield, goggles, or glasses that complies with ANSI Z87.1 and CSA Z94.3 standards. Common eyeglasses are not safety glasses, and may not provide adequate protection.
5. **EAR PROTECTION**: Use hearing protective devices where the noise exceeds the level of exposure allowed in Section 1910.95 of the OSHA Regulations. When in doubt, use it.
6. **OTHER PERSONAL PROTECTION**: Before the operation, remove tie, rings, watch, and other jewelry. Roll up sleeves above elbows. Remove all loose outer clothing and confine long hair. Protective footwear should be used. Do not wear gloves when operating woodworking machinery. However, it is recommended to wear protective gloves when servicing machines.
7. **GUARDS**: Keep machine guards in place for all applicable operations. If any guards are removed for maintenance, DO NOT OPERATE the machine until all guards are reinstalled. Check clearance between the guards and the cutter before starting the machine.
8. **WORKPLACE SAFETY**: Keep the floor around the machine clean. Scrap material, sawdust, oil, and other liquids increase the risk of tripping or slipping. Be sure to clean up the table before starting the machine. Make certain the work area is well lighted and that a proper exhaust system is used to

minimize dust. Use anti-skid floor strips on the floor area where the operator normally stands and mark off the machine work area. Provide adequate workspace around the machine.

9. **ACCESS CONTROL** should be enforced so only trained personnel can access the work area and operate the machine. Use a childproof power switch when applicable.
10. **STAY ALERT** at all times. Do not operate this machine while under the influence of drugs/alcohol, or when not feeling well.
11. **NEVER STAND ON MACHINE.** This prevents injuries from tipping related accidents and accidental contacts with cutters.
12. **REPLACEMENT PARTS:** Use only genuine Oliver Machinery replacement parts and accessories recommended for this machine. Generic parts made by other manufacturers may create a safety hazard and WILL void the factory warranty and other guarantees.
13. **PROPER USE:** Do not use this machine for anything other than its intended use. If used for other purposes, Oliver Machinery disclaims any real or implied warranty and holds itself harmless for any injury or damage which may result from that use.

Safety Guidelines Specific to Jointer

Before Work Begins:

1. **USE ONLY NATURAL, SOLID WOOD.** Do not joint any material such as plywood, MDF, OSB, laminate, or anything that can disintegrate during operation. Do not joint treated lumber or anything that contains harmful chemicals, as this will spread wood dust that contains such harmful chemicals. Do not attempt to joint any workpiece with loose knots or with any other foreign materials.
2. **CHECK CUTTER INSERTS:** Make sure cutter inserts are sharp, clean, and free from damages. Forcing dull/damaged cutter inserts to work invites accidents and impacts finish quality. Use the recommended amount of torque to securely fasten all inserts onto the cutterhead.
3. **SERVICING CUTTER INSERTS:** Wear heavy-duty leather gloves to protect your hands when installing new cutter inserts or rotating the existing ones. Ensure the cutterhead is thoroughly cleaned before installing the insert. Debris between the cutter insert and the platform can create uneven pressure, causing the insert to break, and body injuries may occur.
4. **CHECK CUTTERHEAD GUARD:** Make sure the cutterhead guard is installed and is properly tensioned. The cutterhead guard should spring back and push against the fence after it is rotated away and released.
5. **CHECK OUTFEED TABLE HEIGHT AND ALIGNMENT** to avoid a workpiece getting stuck while feeding. The outfeed table should be flush with or slightly below the cutting arc of the cutterhead.
6. **CHECK DEPTH OF CUT SETTING.** The maximum depth of cut for each pass is 1/8".
7. **SUPPORT LONG WORKPIECE** with auxiliary stock feeding rollers/tables. This helps to avoid injuries and improves the quality of the finish.

When Jointing:

1. **DUST COLLECTION SYSTEM** is required for this jointer. Please make sure the system is on and provide enough suction before starting the jointer.
2. **KICKBACK** happens when a workpiece is ejected at high speed during operation. Kickback projectiles can cause serious injuries or even death. Sudden movements of the workpiece from kickback can also cause hands or other body parts to get pulled into the cutterhead. The operator should be cautious at all times about possible kickback.
3. **PROPER STOCK FEEDING** reduces the chance of kickback. NEVER start the machine with anything engaging the cutterhead. NEVER start feeding until the jointer has reached its full speed. Use the right amount of downward pressure and forward force for feeding.
4. **INSPECT WORKPIECE.** Ensure the workpiece is free from nails, loose knots, and other foreign material. Use a metal detector to scan for metal objects as appropriate.
5. **NEVER** joint material shorter than 10", thinner than 3/4", or narrower than 2". This reduces the risk of accidental contact with the cutterhead.
6. **NEVER** rabbet material with width or thickness less than 3/4", or shorter than 10".
7. **FOLLOW THE 3-INCH RULE.** Always use push blocks when jointing materials less than 3" in thickness or width. Keep your hands at least three inches away from the cutterhead at all times when the machine is running.
8. **CUPPED WORKPIECE** should be jointed with the cupped side facing down. This prevents the workpiece from rocking when feeding through the jointer.
9. **PAY ATTENTION TO THE GRAIN DIRECTION.** Always cut WITH the grain whenever possible. Jointing against or across the grain, or jointing the end grain increases the chance of tear-out and kickback.

After Operation

1. **STOP THE MACHINE** if the operator leaves the machine for any reason.
2. **WAIT** until the machine comes to a complete stop.
3. **CLEAN UP** and **LOCK POWER SWITCH** before departure.

Electricals

 WARNING All electrical work must be done by a qualified electrician and must meet the electrical code in your area.
--

Minimum Circuit Size Required for Model 4235 Jointer

Stock Number	Minimum Circuit Size Required
4235.201	15A8A

Please ensure the electrical circuit for this machine meets the minimum circuit size requirement. The minimum circuit size requirement applies to a dedicated circuit that provides power to one 4235 Jointer. If more machines are sharing the same circuit, consult a qualified electrician to ensure the designated circuit is properly sized for safe operation.

If a circuit is available, but not meeting the minimum circuit size requirement listed above, a new circuit must be installed for this machine.

Grounding

 WARNING Improper grounding can cause electric shock, fire, and equipment damage.
--

Proper grounding reduces the risk to the operator in the event of electrical malfunction or breakdown. This machine must be connected to the grounding conductor when available, and all grounding connections must meet or exceed the electrical code requirements in your area. Furthermore, all grounds must be verified and must meet or exceed the electrical requirement of the machine. If grounding is not available, consider the use of a GFCI protection device as an alternative, if this complies with the electric code in your area.

Electrical Wiring

This machine is pre-wired for 230V with a cord and a NEMA 6-15 plug. Please refer to the section “Wiring Diagram” on page 50 for rewiring this machine for 230V operations. A 230V compatible plug is required.

Use of extension cord is not recommended. If you need to use an extension cord to connect to a power source, select a durable cord type with high-temperature rating (90C° or above). Use the minimum amount of extension cord as needed.

Minimum cord size (AWG) required based on amperage draw and length of the cord:

<i>Amps</i>	Power Cord Length				
	25 feet	50 feet	75 feet	100 feet	> 100 feet
< 5	16	14	14	14	NR
5 to 8	14	14	14	12	
8 to 12	14	14	12	10	
12 to 15	12	12	10	10	
15 to 20	10	10	10	NR	
21 to 30	10	NR	NR	NR	

*NR: Not Recommended

 WARNING	<p>Use properly sized wires that meet or exceed the power requirement of your machine. Using undersized wires may cause overheating and increase the risk of fire and machine damage.</p>
---	--

Setup

Shop Preparation

Space Requirement

The dimensions of this machine are 72-1/4"(L) x 25"(W). You will need additional spaces for manipulating your workpiece, electrical connection, and dust collection.

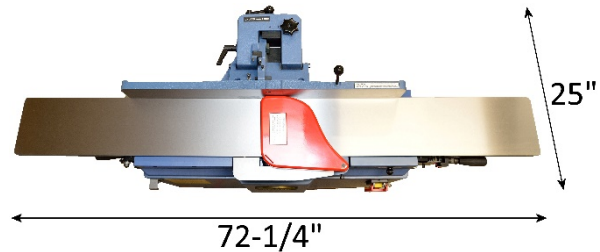

Load Limits

This machine has a shipping weight of 489 lbs., and a net weight of 352 lbs. Please ensure all lifting tools and building structures have adequate load capacity, for transporting and supporting the total weight of this machine, the operator, and related items.

Electricals

Ensure a properly sized circuit and an electrical terminal are available nearby the machine. If the machine is to be hardwired, there must be a readily accessible power disconnect nearby, so that the machine can be disconnected from the power source for servicing and adjustments. If the machine is to be connected with a cord and a plug, please ensure a matching outlet is installed nearby the machine.

Please refer to the previous chapter “Electricals” on page 14 for details regarding electrical requirements.

Lighting

Adequate lighting is needed for operating this machine. Overhead, non-glare lighting should be installed.

Safety Labels

If this machine introduces a new safety hazard to your workplace, display proper warning signs in a highly visible location(s).

Dust Collection

Wood dust created by this jointer is a health hazard. Connect a dust collection system to this machine. Check air suction regularly to ensure the pipes are not jammed.

Dust masks should be available for using the jointer.



CAUTION

Use a dust collection system that is rated above 500 CFM. Doing so improves air quality in the workplace, and prevents the machine from jamming.

Piping of dust collection system introduces additional air resistance and decreases the effective CFM measured at the dust ports. Ensure there is significant suction at the dust port, so dust and debris can be effectively removed from the machine.

Receiving

Your shipment should come with one wood crate. Upon receiving your shipment, check for any significant damages before signing the delivery confirmation.

IMPORTANT

If items are damaged, please call us immediately at **1-800-559-5065**

Moving Machine into the Shop

Your machine will be delivered by freight service, and it will be left outside of your workshop by default. On the day of delivery, please be sure help is available to move the machine to its final location.



4235 Jointer has a gross weight of 489 lbs. and a net weight of 352 lbs.

Safe moving techniques and proper lifting equipment are required, or serious personal injury may occur.



Your shipment may be secured by the straps. Do not lift your shipment by the strap. They are not designed to hold the total weight of your shipment. They may snap without warning and cause serious injury and machine damage.

Always wear safety goggles and gloves when removing straps, as they may spring back violently when released and cause injury.

IMPORTANT

Install the provided lifting hooks and use them for lifting the jointer. Do not lift the machine by the tables as it may alter the alignment of the tables.

Unboxing

The crate contains a jointer that is mostly assembled. It also contains two paper boxes with loose parts and accessories. Everything is covered by a plastic bag.



Inventory

Carefully unwrap the packaging and inventory the items received:



Item	Description	Quantity
1	T-Handle torx drivers (T-25)	2
2	Spare Cutter Inserts Spare Torx Screws	5 10
3	8/10 mm Open End Wrench	1
4	11/13 mm Open End Wrench	1
5	Metric hex wrench set (3mm, 6mm)	1
6	Push blocks	2
7	Cutterhead guard	1
8	Lifting Hooks Cap Screws Spring Washers	2 4 4
9	Caster Lock Knobs	2

NOTICE: If you cannot find an item in the list above, please check if it is still attached to the packaging or inside the cabinet. Occasionally the item may have been pre-installed in the factory. See section “**Parts List**” to check if a component is included or installed.

NOTICE: This machine comes with various standard-sized, non-proprietary parts. If any of these parts are missing, we are happy to deliver them to you. To have the machine up and running as soon as possible, you can also find these parts at your local hardware store.

Additional Items Recommended for Machine Setup

Item	Purpose
Safety Glasses	Protection
Disposable Gloves	Protection
Paper Towel / Rags	Cleaning
Rust Inhibitor	Cast iron rust protection.
Straight edge	Check alignments.
Metric Hex Wrench Set	Assembly and Maintenance
Torque Wrench	Cutter inserts installation and for checking Torx screw tension (52-60 lb-in).
T25 Star Bit Socket	Cutter inserts installation.

Cleaning

To prevent rusting, the unpainted cast iron surfaces of this jointer are covered with machine oil and plastic film.

Loosen the fence tilt lock [1] to and use the handle [2] to lift up the fence. Lock the fence in place, then remove the packaging. Release the fence position lock [3], and use the fence position knob [4] to move the fence all the way back for cleaning. Lock the fence and wipe off machine oil with paper towels or rags.

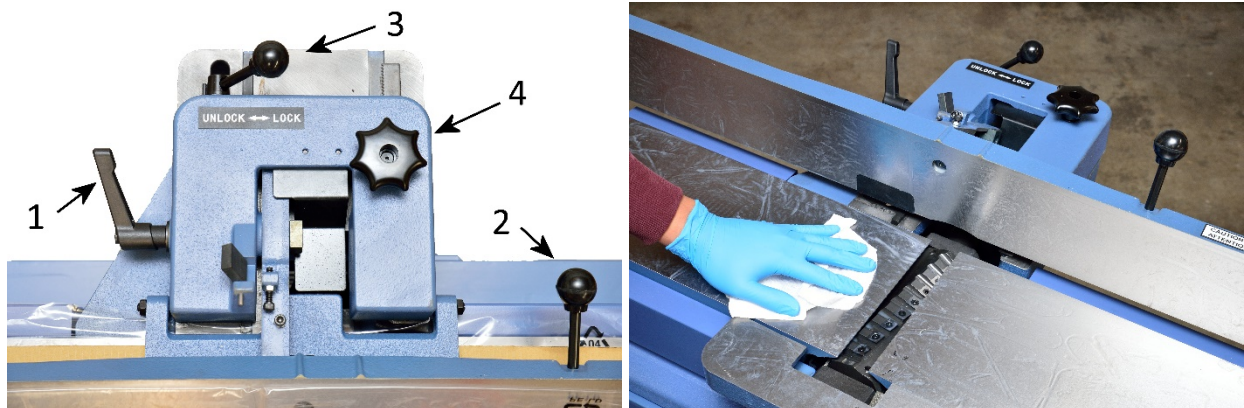

After the initial cleaning, routinely coat the unpainted cast iron surface with rust preventive such as Boeshield® T-9 or paste wax. Do not use rust preventives that contain silicone, which is known to interfere with certain finishes and glues.

Assembly

This jointer is mostly assembled in the factory. There are a few more steps to complete before the machine is ready for a test run:

1. Install lifting hooks.
2. Install caster lock knobs.
3. Inspect / Adjust Jointer Tables (optional).
4. Install cutterhead guard.
5. Connect jointer to a dust collection system.

Cleaning and assembly will take approximately 45 minutes.

Install Lifting Hooks

Before moving the machine to its final location, install the lifting hooks. Use the cap screw and spring washers to secure the lifting hooks on the front and back of the cabinet.



Install Caster Lock Knobs

The caster lock knobs prevent this jointer from moving. Lightly lubricate the threads of the knobs before installation. To lock the casters, install and rotate the knobs until the casters stop moving.

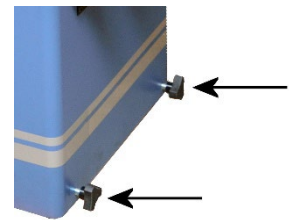

IMPORTANT

Do not overtighten the knob as it will damage the casters.

Inspect / Adjust Jointer Tables

The jointer tables are calibrated in the factory and should not require adjustments initially. Refer to section "Maintenance -> Inspect / Adjust Jointer Tables" on page 36 to perform these steps if needed.

Install Cutterhead Guard

1. Loosen fence tilt lock [1]. Lift up and tilt back the fence using the handle [2]. Lock the fence in the tilted position. Unlock the fence position lock [3] and rotate the fence position knob [4] to move the fence all the way back.
4. Rotate the fence away. Lower the fence and set it to 90 degrees. Make sure the guard is pressing against the fence.

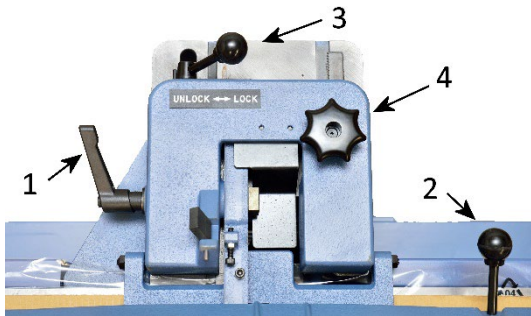

2. Insert the cutterhead guard shaft through the hole that is on the rabbeting table. Move the guard under the elevated fence so it goes beyond the other end of the jointer table. Tighten the cap screw to lock the cutterhead guard shaft in place.

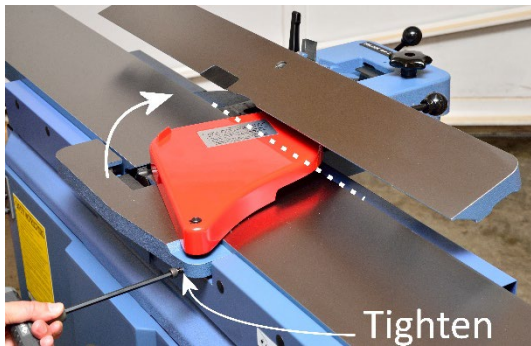

3. The fence should be installed as low as possible, but still be able to rotate freely without scratching the table. Adjust the height of the guard as needed.



WARNING

Always operate this jointer with a cutterhead guard, except for some rabbeting operations, or serious personal injury can occur.

Lifting Machine

Attach the lifting sling to the lifting hooks. Gently lift the machine from the crate and move it to its final location.

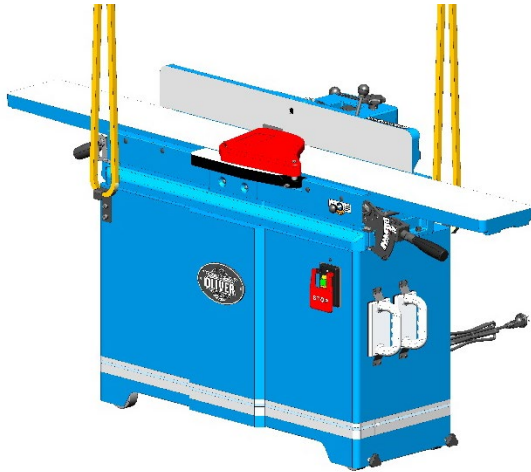

!WARNING

4235 Jointer has a net weight of 352 lbs. Only use lifting devices that are capable of handling the load, or serious personal injury and machine damage can occur.

IMPORTANT

Use the provided lifting hooks to move the jointer. Do not lift the machine by the tables as it may alter the alignment of the tables.

Dust Collection

This jointer can generate a lot of wood shavings and dust. Connect a dust collection system to this machine.

The minimum CFM requirement for this jointer is 500 CFM at the dust port, which means your dust collection system should have a rating greater than 500 CFM, as air friction and leakage reduce effective CFM at the dust port.



IMPORTANT

Running this jointer without a dust collection system, or using an underpowered system, will cause dust and shavings to accumulate inside the jointer. This can damage the machine and cause other hazardous situations. Check your dust collection system regularly to make sure it is not jammed or filled up.

Controls and Components

Powerswitch

This jointer is equipped with a magnetic paddle switch. Make sure the paddle is installed before turning on the machine. The paddle allows the operator to easily turn off the machine in case of an emergency.

If the power goes out while the machine is running, this magnetic power switch will turn off automatically. This prevents the machine from restarting expectedly when power resumes.



This switch also comes with a safety feature to prevent the jointer from turning on by accident. Lock the switch by inserting a pin or padlock (not included) through the "ON" button. Test the locking device to make sure it can disable the switch.

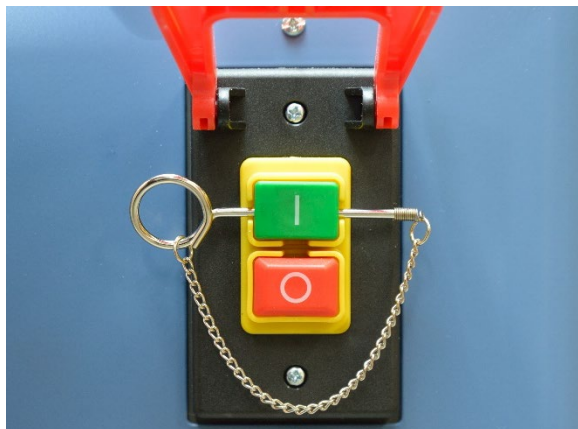

Infeed Table Adjustment

The infeed table adjustment lever and depth scale are located right below the infeed table:

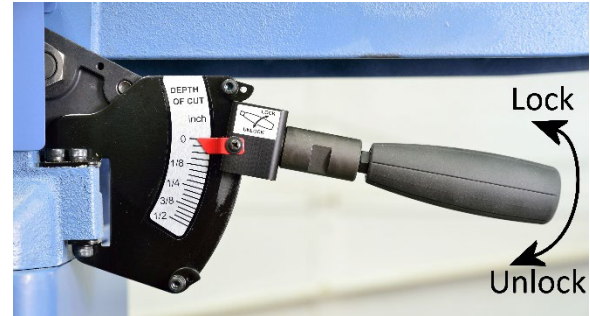

To adjust infeed table height:

1. Rotate the handle counterclockwise to loosen the locking mechanism.
2. Use the depth scale to set the infeed table height.
3. Rotate the handle clockwise to lock the table in place.

Infeed Table Depth Stop Knob

This jointer has a maximum depth-of-cut capacity of 1/8" for jointing operations. The purpose of the depth stop is to prevent making a cut greater than 1/8" deep.

To create a rabbet with more than 1/8" in depth, make several passes to gradually remove the materials. Pull and hold the knob when lowering the infeed table below 1/8".



Outfeed Table Height Adjustment

The outfeed table height adjustment lever is located below the outfeed table and is locked by a cap screw.

The height of the outfeed table was set in the factory and it should not require adjustments initially.

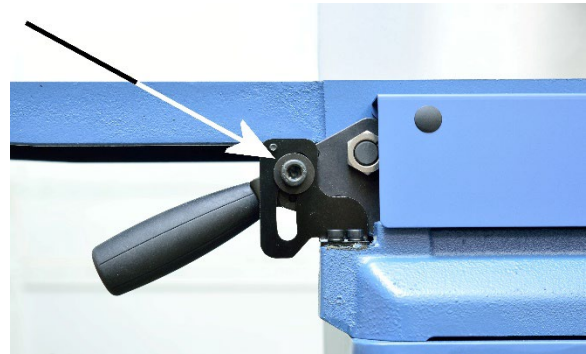

Fence

Fence Tilt

The cast iron fence assembly has three adjustable positive stops at 45°, 90°, and 135°.

To set the fence at 90°, flip the 90° stop block to the right. Make sure the 90° stop bolt is resting on the 90° stop block. To tilt the fence, flip the 90° stop block to the left.

Fence Positioning

Use the fence position knob to set the amount of cutterhead exposed. This jointer can joint boards up to 8" wide when moving the fence all the way back. Moving the fence to other positions while jointing boards of different sizes helps to average the usage of the cutters.

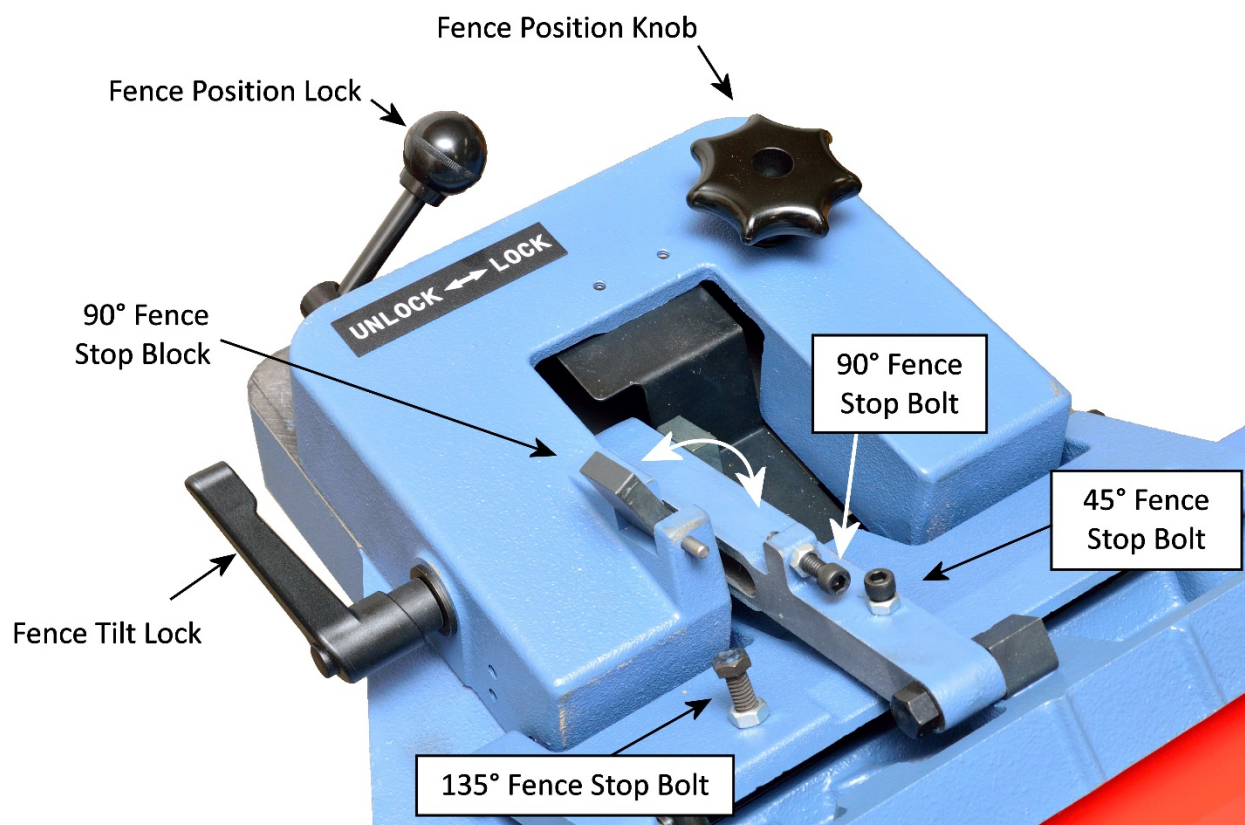

WARNING

Tighten both fence tilt lock and fence position lock before starting the machine. A loose fence can lead to loss of control of the workpiece, which can cause severe injury.

Test Run

Each jointer has been inspected and calibrated before leaving the factory to meet our quality and precision standards. Due to various reasons, this jointer may need to be re-adjusted when it arrives at your workshop. It is recommended to complete this test run before using the jointer for production work.

1. Remove all tools and debris from the machine. Ensure this jointer is disconnected from the power source.
2. Set the fence to 90 degrees. Move it all the way back to expose the entire jointer table. Ensure the cutterhead guard is pushing against the fence.



3. Rotate the guard to expose the entire cutterhead, then gently release the guard. The cutterhead guard should spring back to its original position.



WARNING: If the cutterhead guard fails to push against the fence, **STOP HERE**. Adjust guard tension before resuming the test run.

4. Press the STOP button.
5. Connect this jointer to a power source.
6. Press the green “ON” button. This jointer should be running with no excessive noise and vibration.
7. Disconnect the machine from the power source while it is running. The magnetic power switch should turn off automatically as it is disconnected from power. Reconnect the machine to power and the machine should **NOT** restart.
8. Set infeed table depth of cut to 1/32”.
9. Turn on the dust collection system and the jointer.
10. Surface plane a test workpiece. See section “Surface Planing” on page 29 for detailed instructions. The workpiece should move through the jointer with ease.
11. Inspect the workpiece for unusual tear out and other defects.

Congratulations! You have completed the test run! Now your jointer is ready for production work. If you discover any issues from the tests, please refer to the troubleshooting section and maintenance section to diagnose issues and make adjustments.

Operation

Preparation

For safety and to achieve the best results, please take the following steps before jointing a workpiece.

Inspect Workpiece

Only use this jointer for natural, quality wood materials. Cracked stock, board with loose knots, plywood, and other engineered wood products can break apart and cause severe kickbacks, which can lead to severe injuries and machine damages.

Do not use this jointer to cut treated lumber or anything that contains harmful chemicals. This will spread wood dust that contains such harmful chemicals.

Carefully inspect workpieces for foreign objects. Nails, staples, rock chips, and other objects embedded on the wood surface will damage the jointer. It is advised to clean a workpiece with a stiff brush to remove all dirt and foreign objects ahead of time, especially for rough sawn or reclaimed lumber. Use a metal detector to scan for metal objects as needed.

Check Dimensions

To avoid accidental contact with the cutterhead, NEVER process stock that is:

1. Shorter than 10"
2. Thinner than 3/4" (for surface planing)
3. Less than 2" wide (for surface planing)

Support Long Workpiece

Support long stock with rollers or other devices to avoid injuries. This also helps to create a smooth, consistent finish.

Check Moisture Content

Check the moisture content of workpieces. "Green wood" with moisture content over 20% will not cut properly and may jam the machine. Excessive moisture content will also cause the jointer's unpainted surface to rust. Besides, as the workpiece dries, the once-flattened surface can become fuzzy and warped again. It is recommended to allow a workpiece to dry and stabilize before it is processed.

Warped Stock

Avoid using severely warped boards, as they can be unstable and might cause severe kickback or disintegrate when it is cut.

Glue Deposits

Glue left on the workpiece surface can dull cutters and lower cut quality. Scrape off all glue deposits from the workpiece before jointing a workpiece.

Inspect Wood Grain

To achieve optimal results, cut WITH the grain. Inspect the wood grain from the side of a workpiece to determine the feed direction. Avoid cutting against/across/end grain as severe kickback and chipping may occur.

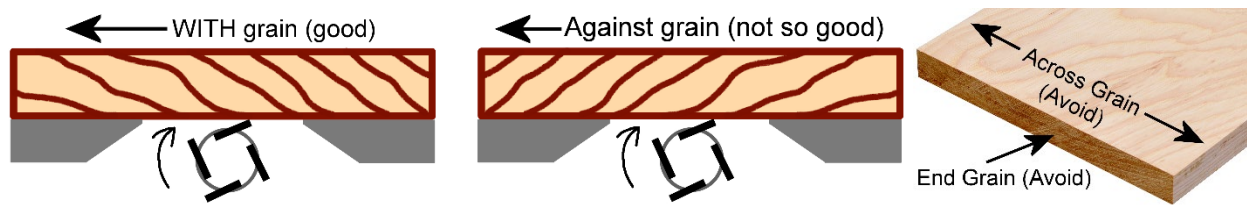

Sometimes it is impossible to cut with the grain for the entire length of a workpiece. In this case, try feeding the workpiece in opposite direction and see what works best. Reducing the depth of cut and feed rate can also help to improve the cut quality.

Squaring Stock

Jointer is commonly used in conjunction with planer and table saw for squaring stock. Rough, warped stock is milled so it becomes flat and square. It takes four steps for squaring stock:

1. Surface Planing - The bottom face of the stock is flattened by a jointer. The concaved face should be chosen for this step.
2. Thickness Planing - The top face of the stock is flattened by a thickness planer. In this step, the workpiece can be planed down to the desired thickness.
3. Edge Jointing - The concaved edge is straightened and squared on a jointer.
4. The last edge is straightened with a rip cut on a table saw, with the jointed edge placed against the table saw fence. In this step, the workpiece can be cut to the desired width.

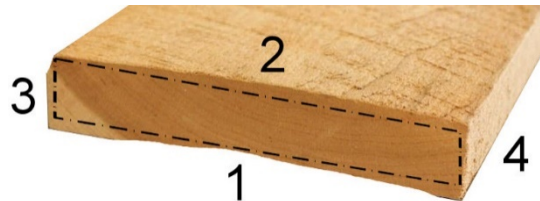

Serious injury or death can result from machine kickback or accidental contact to the cutterhead. Follow these safety rules to reduce your risks for all jointing operations:



- Begin operation with the concave, or the most stable surface for jointing.
- Feed stock with a stable stance and at a steady rate.
- Use eye and ear protection devices.
- Cutterhead guard must be installed for all jointing operations.
- Keep hands at least 3" away from the cutterhead.
- Use push blocks whenever possible.



Ensure the dust collection system is functional and use a dust mask. Inhaling harmful airborne particles can cause serious, long-term health issues.

Surface Planing

1. Inspect stock for quality issues and grain orientation before the operation. Begin surface planing with the concave face when present (see examples on the right).
2. Adjust the depth of cut by setting the elevation of the infeed table. Woodworkers typically set the depth of cut to 1/16" or less to allow better control over the workpiece, and to reduce wastage.

If needed, this jointer is capable of removing 1/8" of materials per pass.

3. Set the fence to 90°.
4. Start the jointer and the dust collection system.
5. To initiate a cut, stand near the infeed table and slightly behind the cutterhead. Place the workpiece on the infeed table. Use the push block in the left hand to feed stock against the fence and the infeed table, and use the push block in the right hand to feed the stock from the back.

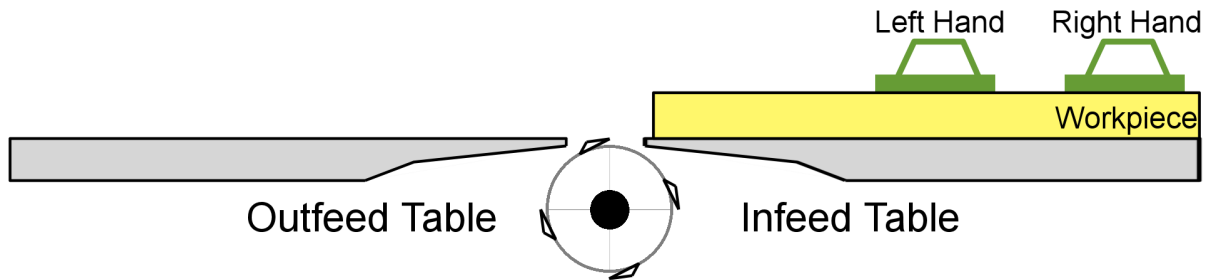
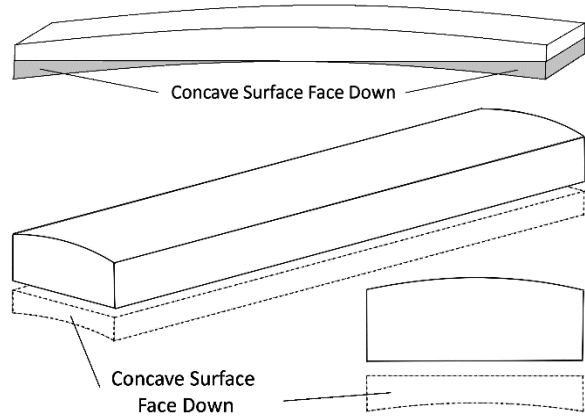

6. Feed a small section of the workpiece across the cutterhead. Keep it under control but do not apply excessive pressure to bend it flat on the table.

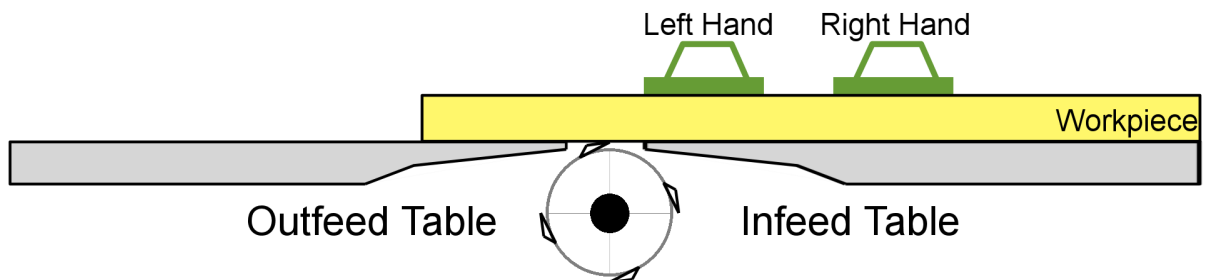

7. As the left feeding hand approaching the cutterhead, stop feeding. Carefully lift the left-hand push block and use it to feed the portion of the workpiece that is on the outfeed table. Maintain control of the workpiece with the right hand while repositioning the left hand.

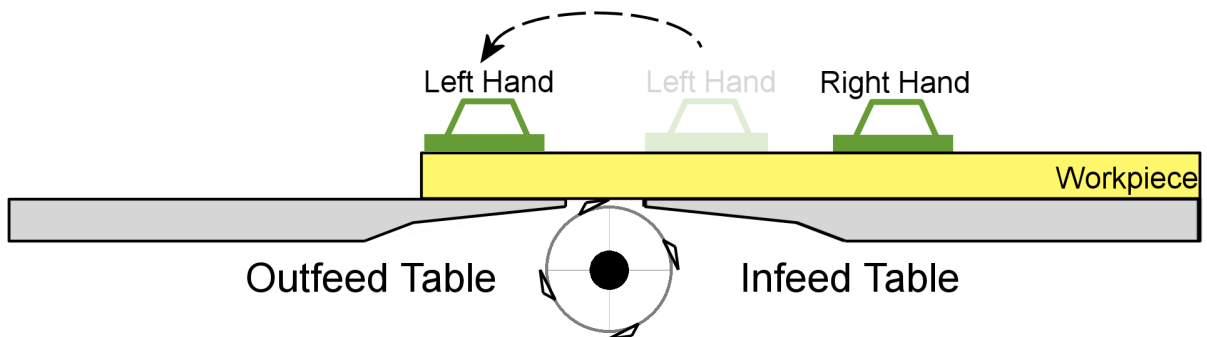

- As the right feeding hand approaches the cutterhead, stop feeding. Carefully lift the right-hand push block and move the entire body towards the outfeed table. Place right-hand push block on the stock that sits on the outfeed table. Use the left hand to maintain control of the stock while repositioning the right hand.

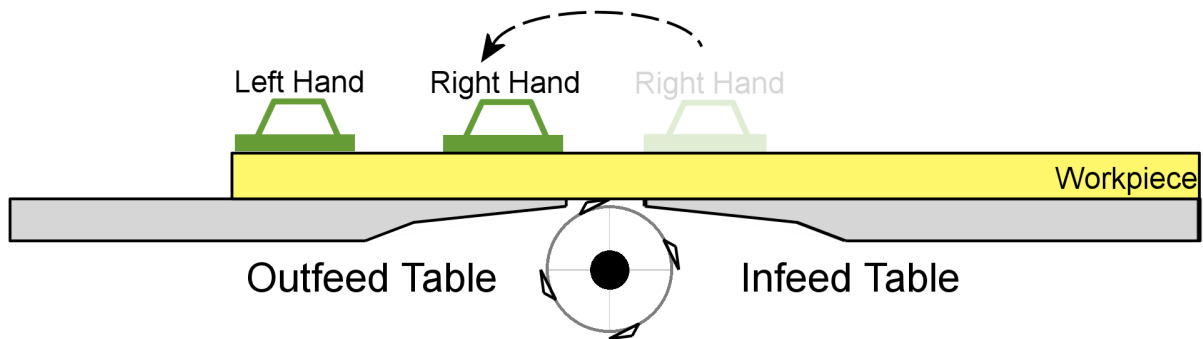

- From this point on, continue to feed stock only on the outfeed table until the entire length of the stock is planed. Feed stock at a steady rate to produce a smooth surface with no burn marks.
- If the stock cannot be flattened in a single pass, repeat steps 5-9 until the entire surface is cut flat.

TIP: For new jointer users, practice stock feeding with the depth of cut set to 0". This helps to perfect the feeding technique before actual operations.

TIP: To ensure the entire surface is cut, some woodworkers leave pencil marks on the entire length of stock before the final passes, then verify all marks are removed after a pass.

TIP: Do not feed thin stock with excessive downward pressure. This will flatten any cup or warp workpiece as it passes through the cutterhead, but it will spring back to its original shape when pressure is released. Only apply adequate pressure to maintain control of the stock when feeding.

Edge Jointing

1. Set the fence to 90°.
2. Inspect stock for quality issues and grain orientation. Make sure the stock has a flat surface to feed against the fence. For crooked stock, begin edge jointing with the concaved edge.

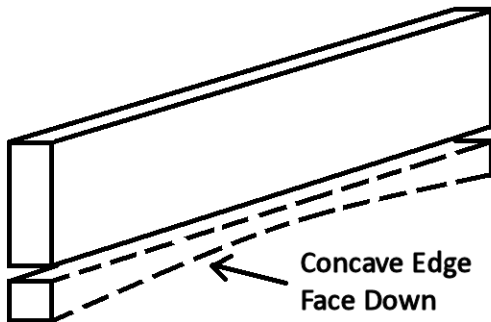

3. Set the depth of cut. If an edge is almost flat and squared, set the depth of cut to only remove as much material as needed to obtain a jointed edge. This jointer can remove at most 1/8" of materials per pass.

Stock that has a rough edge may take multiple passes to joint it straight and squared. For some extreme cases, consider using a saw and a special jig to create a roughly straight edge before jointing.

4. Start the dust collection system and the jointer.
5. Place the workpiece on the infeed table, then use push blocks to hold it against the fence and the table to initiate a cut.



Be very careful when jointing narrow boards. Use push blocks to keep hands away from the cutterhead. Position both hands and the push blocks above the cutterhead guard when feeding.

When edge jointing a board that is much taller than the fence, using the right hand to hold the board will provide better control. Continue to use a push block on the left hand to keep it away from the cutterhead.

Be sure the right hand is securely resting on top of stock and it is away from the cutterhead at all times.

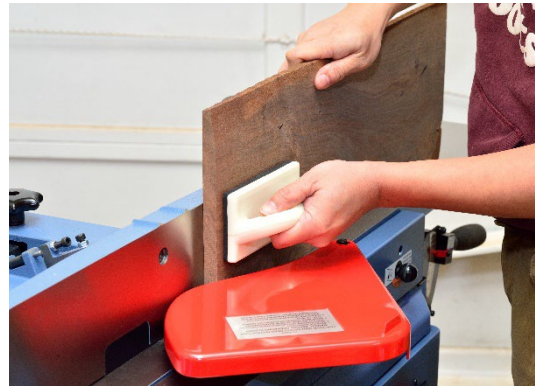

6. Feed the entire length of the stock through the cutterhead. Maintain a stable, balanced stance for the entire process.
7. For long stock, feed a section past the cutterhead, then continue to feed the remaining length while standing next to the outfeed table.
8. Repeat the process until the entire edge is jointed flat and square.

TIP: Occasionally adjust fence position to make use of the outboard edge of the cutterhead. This helps to average the use of the cutters.

Beveling

Instructions and precautions for edge jointing apply to beveling. Besides:

- When cutting a bevel that is not 90°, lift up the 90° fence stop block, then set the fence tilt to the desired angle of cut using a protractor.
- Reduce the maximum depth of cut from 1/8" to 1/16" or less based on the width of the bevel and hardness of the workpiece.

Rabbet Cutting

A rabbet is a groove cut along the edge of a workpiece. This jointer is capable of making rabbet cuts as deep as 1/2". Depends on the requirements and constraints of your project, a jointer, or other tools such as a table saw, router, or other hand tools, can be the best tool for your rabbeting needs. Always consider safety when choosing a tool for rabbeting.

Performing a rabbet cut with this jointer may require the cutterhead guard removed. Promptly re-install the guard after the rabbeting operation completes.

1. **Inspect stock for quality issues before the operation. The surfaces for rabbeting must be flat and squared.**

2. Set fence to 90°

3. Reposition the fence to set the width of a cut. The amount of exposed cutterhead is the width of the rabbet.

Please beware that the cutters are installed in staggered formation, and the outermost edge of the cutter is located near the edge of the table. Make test cuts to confirm the width of the cut as needed.

4. Remove the cutterhead guard as needed.

5. Start the jointer and dust collection system.

6. Place workpiece against the fence and infeed-rabbeting table. Use push blocks whenever permissible.



7. Follow steps [5-9] in "Surface Planing" for feeding stock through the jointer. Repeat the process until reaching the desired depth of the rabbet cut.

CAUTION: Beware that the rabbeting table is short and narrow. Take extra caution and support of the entire workpiece throughout the operation.

8. Lower the infeed table gradually to remove a portion of the material in each pass until reaching the desired depth of cut. As much as 1/8" of materials can be removed per pass.

CAUTION: For safety, never cut more than 1/8" per pass.

9. Disengage the infeed table depth stop when the infeed table needs to go below 1/8". This jointer can produce a rabbet that is 1/2" deep.



10. Reinstall cutterhead guard after the rabbeting operation.



WARNING

If the cutterhead guard is removed for rabbeting operation, use extreme caution when performing cuts. Reinstall the guard immediately when the operation completes.

Common Cutting Problems

Snipe

Occurs when too much pressure is applied as a workpiece enters or leaves the cutterhead. Improper table settings can also introduce snipes.

To mitigate this problem, apply even feed pressure throughout the entire workpiece. Once the workpiece went past the cutterhead, downward pressure should be focused on the outfeed table only. Ensure the outfeed table is not positioned way below the cutter head.



Chipping

Happens when cutting against the grain direction. For highly figured lumber, and areas near a knot, some amount of chipping is normal. In this case, reduce the depth of cut and feeding speed. Moistening the problematic area before jointing can sometimes mitigate the issue.

Chipping can also be caused by dirty or dull cutters. If chipping happens while jointing straight grain stocks, inspect the cutter inserts and remove all resin buildups. Rotate/replace dull cutter inserts.



Fuzzy Grain

Can happen when planing wood with high moisture content or if the cutter is dull. Sometimes it is impossible to avoid fuzzy grain due to the nature of certain wood types. To mitigate this issue, avoid using wood with high moisture content and use sharp cutters.

Accessories

Oliver Machinery has a collection of accessories and add-ons to enhance the productivity of your jointer. Please visit our website OLIVERMACHINERY.NET to purchase these items.

You may also call **1-800-559-5065** or email PARTS@OLIVERMACHINERY.NET to place an order. We are available Monday through Friday, 9 AM - 5 PM Pacific Time.

Cutter Inserts



Genuine four-sided indexable carbide cutter insert that will fit the cutterhead of Oliver **4235 Jointer**.

Parts number: **P-15mm 4S**

Touchup Paint



Keeping all painted surfaces in good condition keeps your machine looks nice and prevents rusting. We have pre-mixed spray paint available in Oliver-Blue for purchase.



WARNING

Using unapproved accessories may cause this machine to malfunction and resulting in serious injury and/or machine damage. Only use accessories recommended for this machine.

Maintenance

Routine maintenance keeps your jointer in top shape. Please follow the maintenance schedule below, and use the maintenance record worksheet attached in the back of the manual to document all tasks completed. **NOTICE:** Maintenance schedule may vary for individual users due to different situations and safety requirements.

 WARNING	Disconnect the machine from the power source before any maintenance work is performed. After servicing the jointer, remove all wrenches and tools before restarting the machine. Failure to comply can cause serious injury!
---	---

Maintenance Schedule

Interval	Task
Every day	Inspect the power cord for signs of aging and damages before starting the machine. Replace worn parts as needed.
	Remove dust buildups from the jointer table and dust collection system after use.
Every week	Inspect and clean the cutterhead. Remove any dust and resin accumulation.
Every Month	Remove dust under the table and inside the cabinet.
	Inspect/rotate/replace worn cutter inserts.
	Apply rust protectant on unpainted cast iron surfaces.
	Lightly grease the rack and pinion and the joints of the fence assembly.
Every 6 month	Check V-belt tension and replace if the belt shows signs of cracking or glazing.
	Verify infeed/outfeed tables are coplanar.

Notice: Motor bearings are permanently sealed and lubricated and do not require lubrication.

Inspect / Adjust Jointer Tables

Each jointer has been inspected and calibrated in the factory and should not require adjustments initially. When a jointer consistently makes problematic cuts, perform these checks, and make adjustments as needed.

Inspect Outfeed Table Height

1. **Disconnect the jointer from the power source!!**
2. Put on leather gloves.
3. Remove cutterhead guard.
4. Move fence assembly all the way back to expose the entire table.



5. Place a straight edge over the centerline of the outfeed table so it hangs over the cutterhead.

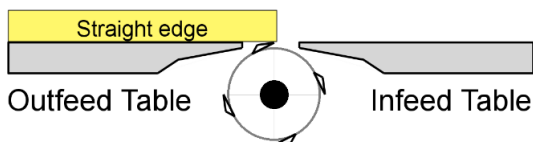
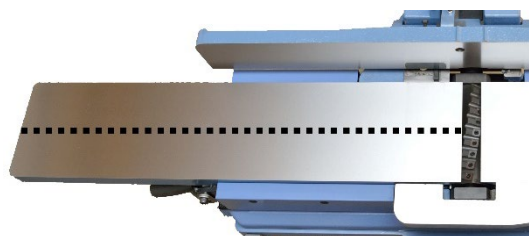

6. When the outfeed table height is properly set, cutters should be barely scraping the straight edge when the cutterhead rotates. Follow the next section to make adjustments as needed.

If the outfeed table height is set properly, jump to section **“Inspect Outfeed Table Parallelism”**.

Adjust Outfeed Table Height

1. **Disconnect the jointer from the power source!!**
2. Loosen the cap screw that locks the outfeed table.

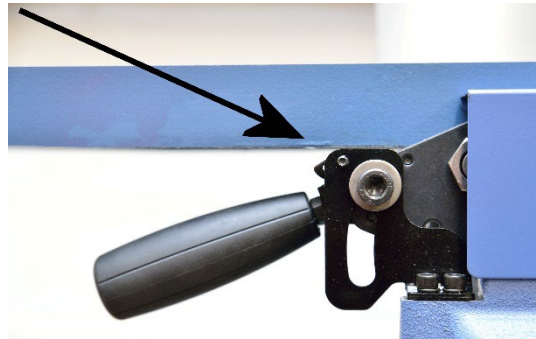

3. Adjust outfeed table height with the lever. Place a straight edge sitting on the outfeed table. When the outfeed table height is set correctly, the cutters should be barely touching the straight edge when the cutterhead rotates.
4. After the outfeed table is adjusted, tighten the locking cap screw to lock it in place.

Inspect Outfeed Table Parallelism

1. **Disconnect the jointer from the power source!!**
2. Place a straight edge on the outfeed table in positions as shown below:

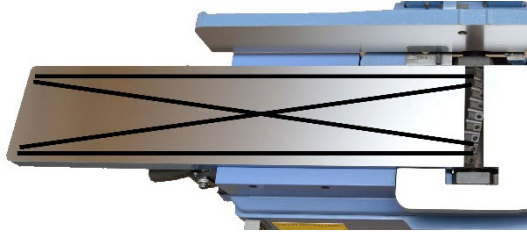

3. Make sure the straight edge is hanging above the cutterhead:

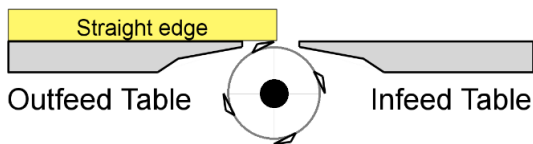

4. In each position, carefully rotate the cutterhead. When the outfeed table is in parallel with the cutterhead, cutters should be barely scraping the straight edge when the cutterhead rotates.
5. If the outfeed table and cutterhead are out of alignment, move to section “**Adjust Table Parallelism/Coplanarity**”.

If the outfeed table is in parallel with the cutterhead, proceed to the next section “**Inspect Infeed Table**”

Inspect Infeed Table

1. **Disconnect the jointer from the power source!!**
2. **NOTICE:** Make sure the outfeed table is properly adjusted before continue.
3. Place a straight edge that splits evenly on both the infeed and the outfeed table.
4. Raise the infeed table so that it is at the same height as the outfeed table. When proper height is set, the straight edge will sit flat and flush on the infeed and the outfeed table. Rotate carbide cutter away if it contacts the straight edge.
5. Move the straight edge across the tables in positions as shown in the picture below. Rotate carbide cutter away if it gets in the way.

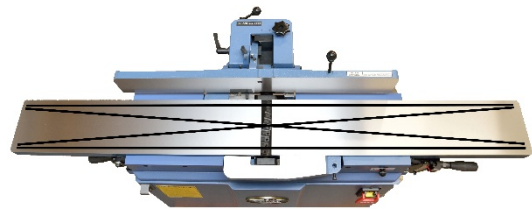

6. In each position, the straight edge should sit flat and fit flush on both infeed and outfeed tables.
7. If infeed/outfeed tables are out of alignment, move to section “**Adjust Table Parallelism/Coplanarity**”.
8. Otherwise, congratulations! The jointer tables are well calibrated for your next project!

Adjust Table Parallelism/Coplanarity

Adjusting table parallelism and coplanarity take time, precision, and patient. The entire process can take over an hour or more. Check the amount of misalignment against tolerance before making adjustments. For best results, use a long and precise straight edge for adjustments.

Measurement	Tolerance
Outfeed Table / Cutterhead Parallelism	$\leq 0.004''$
Infeed / Outfeed Table Parallelism	$\leq 0.01''$

1. **Disconnect the jointer from the power source!!**
2. Remove the depth stop knob.



3. Remove all four metal panels that conceal the parallelogram mechanism.

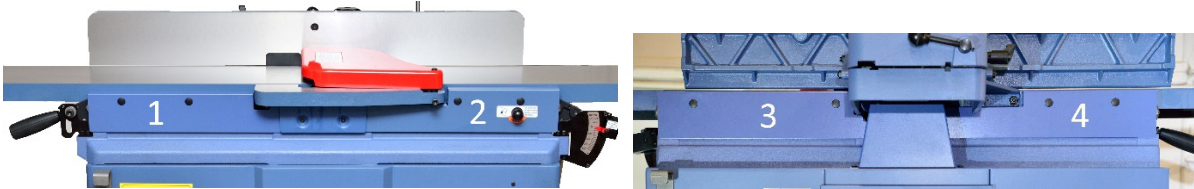

4. Each panel is secured by two cap screws, which are covered by plastic caps. Use a straight head screwdriver to remove the plastic covers on the panels. For panels 1,3, and 4, loosen the hex cap screw with a 5mm hex wrench, and the panels can be lifted.

To remove panel #2, the cap screws must be removed. Use a magnetized hex wrench for this step so the screws won't fall into places that are difficult to reach.

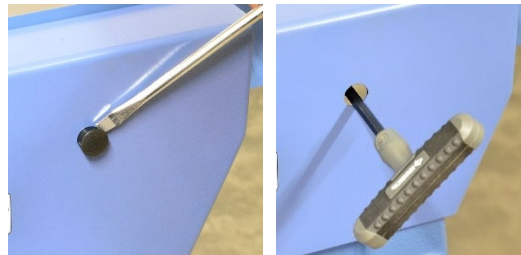

- The following pictures show the jointer with the parallelogram mechanism exposed. Table parallelism /coplanarity can be adjusted by rotating the eccentric nuts. Each infeed/outfeed table has four eccentric nuts for coplanarity adjustments.

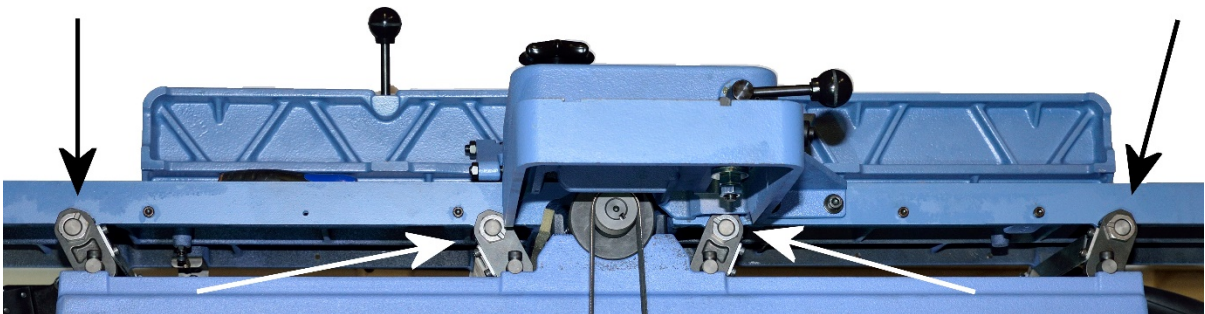
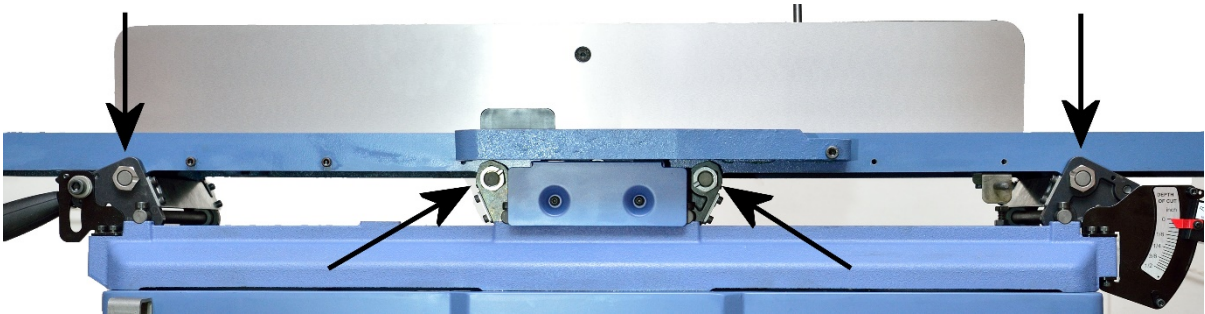

- Begin the table alignment process with the outfeed table. Locate and loosen the set screws for locking the eccentric nuts as shown in the pictures:

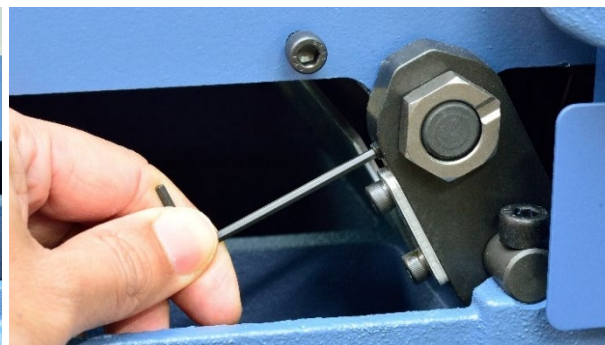
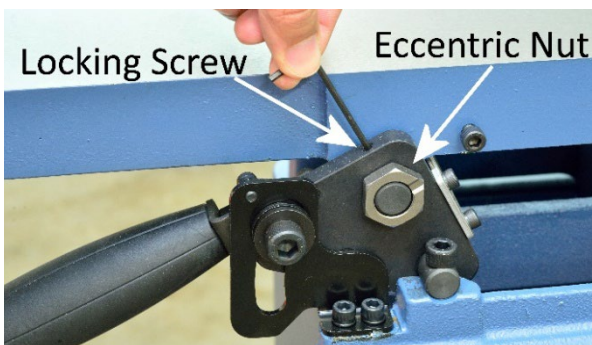

- An eccentric nut should be fairly easy to rotate once the locking set screw is loosened. Rotate the eccentric nuts to align the outfeed table and cutterhead.

IMPORTANT: When adjusting the eccentric nuts, make sure they are fully inserted into the holding bracket. Leaving any gaps in between may cause the table to shift sideways.

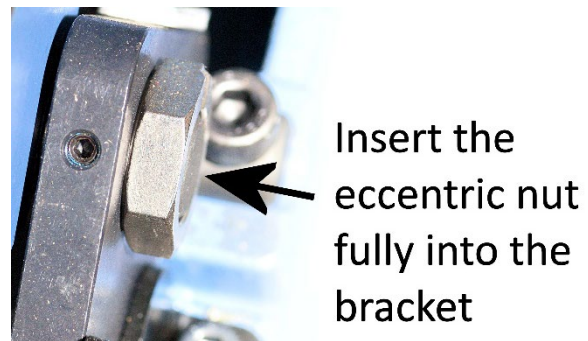

- Repeat the steps in "Inspect Outfeed Table Parallelism" to verify adjustments.

9. When the outfeed table is adjusted, tighten the set screws to lock all outfeed table eccentric nuts.
10. With the outfeed table height set and locked, gently rock the fence to ensure the outfeed table is stable. If the outfeed table is rocking, eliminate all gaps between the table, eccentric nuts, and bracket.
11. Adjust the infeed table using the infeed table eccentric nuts so it is coplanar with the outfeed table. Repeat the steps in “**Inspect Infeed Table**” when making adjustments. Again, make sure the eccentric nut is fully inserted into the bracket.
12. Lock all eccentric nuts when adjustments complete.
13. With the infeed table realigned, it may need additional adjustments. See section “**Infeed Table Adjustments**” for details.
14. Reinstall all panels and cutterhead guard when all adjustments complete.

Infeed Table Adjustments

After a full table realignment, the infeed table height should be re-zeroed, and a few components of the infeed table will need to be adjusted.

1. **Disconnect the jointer from the power source!!**
2. To re-zero infeed table height, raise the infeed table so it is approximately at the same height as the cutting arc of the cutterhead.
3. Place a straight edge over the infeed table so it hangs over the cutterhead.

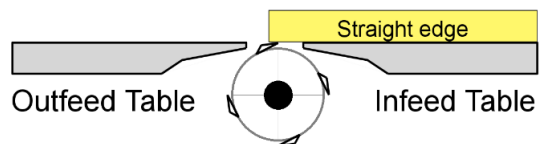

4. Fine-tune the table height to set the depth of cut to zero. When properly set, cutters should be barely scraping the straight edge when the cutterhead rotates.
5. Check if the depth scale is still pointing at zero. If not, loosen the screw on the pointer and adjust its position. Also, check and adjust the quick stop plates to make sure they stop the lever at 0" and 1/2".

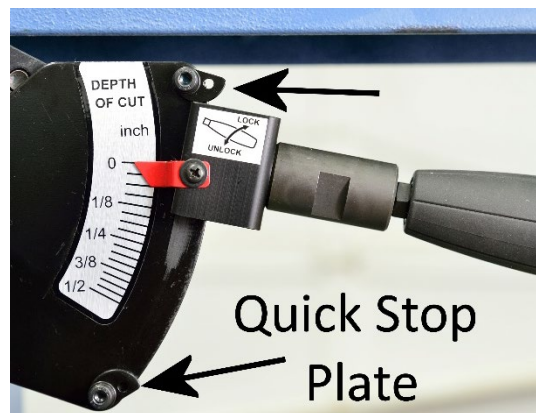

Infeed Table Depth Stop Adjustments

1. **Disconnect the jointer from the power source!!**
2. With the depth stop knob left in place, attempt to lower the infeed table beyond 1/8". If this positive stop is set correctly, it will stop the table at 1/8".
3. If adjustment is needed, the stop nut is located behind the depth stop knob, which can be accessed when panel #2 is removed.



4. Loosen the jam nut to adjust the stop bolt.

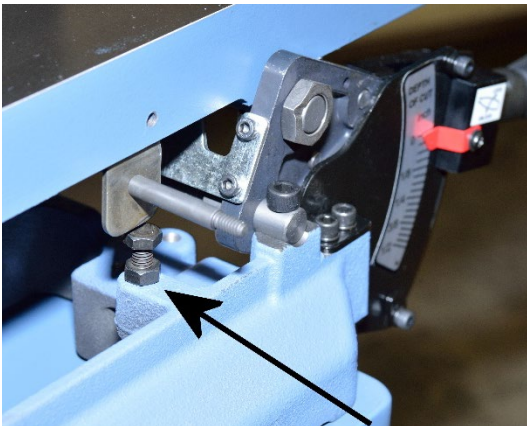

5. Retighten the jam nut when adjustment is done.

Rotate / Replace Cutter Inserts



Cutter inserts are extremely sharp. Wear thick leather gloves to avoid hand injuries.

1. **Disconnect the jointer from the power source!!**
2. Put on leather gloves.
3. Remove cutterhead guard.
4. Move the fence all the way back and raise it above the table to expose the cutterhead.
5. Remove dust and resin accumulations on cutterhead and areas nearby.
6. Inspect the cutter inserts. Rotate the cutter inserts 90° clockwise when they get dulled or nicked. Use a permanent marker to mark the new edge to be used.
7. To rotate/replace a cutter insert, remove the Torx screw with a T-25 Torx bit. Turn **COUNTERCLOCKWISE** to loosen the screw.

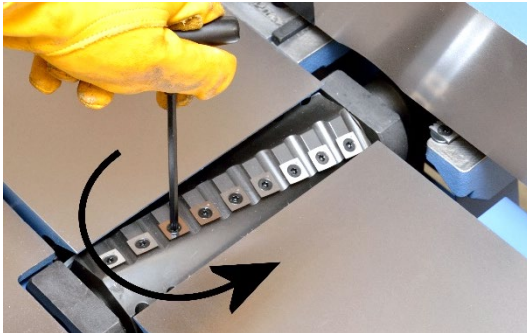

8. With the cutter insert removed from its platform, thoroughly clean the cutter insert platform with a vacuum or compressed air.



IMPORTANT: Obstacles between the insert and cutterhead platform will create uneven pressure against the insert. This will lower cut quality and may cause the insert to crack.

9. Reinstall cutter insert with the marked cutting edge facing out.
10. Inspect the Torx screw. Replace any damaged screws. Lubricate screw thread with a thin coat of lightweight machine oil.

IMPORTANT: Do not use an excessive amount of lubrication, or the Torx screw and the cutter insert will not sit properly.

11. Using a torque wrench, re-tighten the Torx screw with 52-60 lb-inch of torque.

IMPORTANT: Do not overtighten the screw or the inserts may break. Do not use power tools to tighten the Torx screws. Excessive torque can strip the screws or damage the cutter inserts.

12. Reinstall the cutterhead guard and remove all tools from the table when servicing is done.

Adjust Fence Positive Stops

The fence assembly has three positive stops at 45°, 90°, and 135°. They were calibrated in the factory and should not require initial adjustments.

Adjust 90° Positive Stop

1. **Disconnect the jointer from the power source!!**
2. Loosen the fence tilt lock.
3. Locate the 90° stop bolt and the 90° fence stop block.

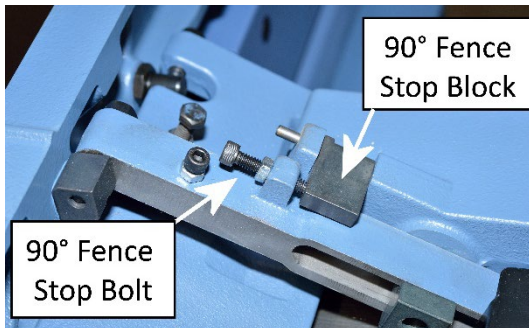

4. Lower the 90° fence stop block and make sure the stop bolt rests on the 90° fence stop block.
5. Place a square or a protractor against the fence to check if it is stopped at 90 degrees. Make adjustments as needed.

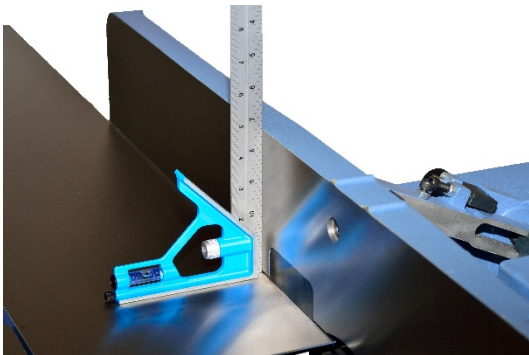

6. To make adjustments, loosen the jam nut and adjust the stop bolt so that it stops the fence at exactly 90 degrees, then hold the stop bolt in place and re-tighten the jam nut.
7. Lock the fence before starting the jointer.

Adjust 45° Positive Stop

1. **Disconnect the jointer from the power source!!**
2. Loosen the fence tilt lock.
3. Tilt the fence forward towards the table, until it is stopped by the 45° stop.

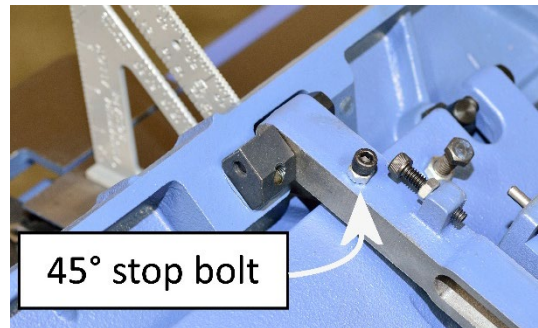

4. Place a speed square or a protractor against the fence to see if it is stopped at 45 degrees.

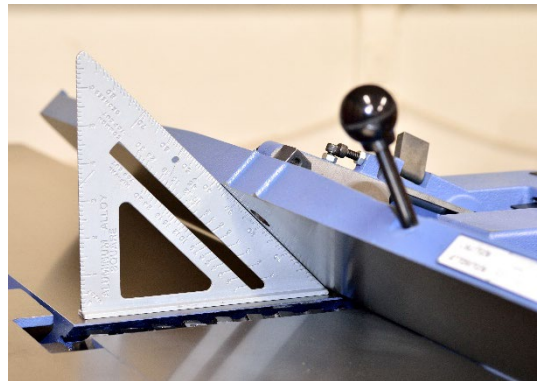

5. If adjustment is needed, loosen the jam nut of the 45° stop bolt, adjust the stop bolt so that it stops the fence at exactly 45 degrees, then hold the stop bolt in place and re-tighten the jam nut.
6. Lock the fence before starting the jointer.

Adjust 135° Positive Stop

1. **Disconnect the jointer from the power source!!**
2. Loosen the fence tilt lock.
3. Lift up the 90° fence stop block, so the fence can be tilted beyond 90°.
6. If adjustment is needed, loosen the jam nut of the 135° stop bolt, adjust the stop bolt so that it stops the fence at exactly 135 degrees, then hold the stop bolt in place and re-tighten the jam nut.
7. Lock the fence before starting the jointer.

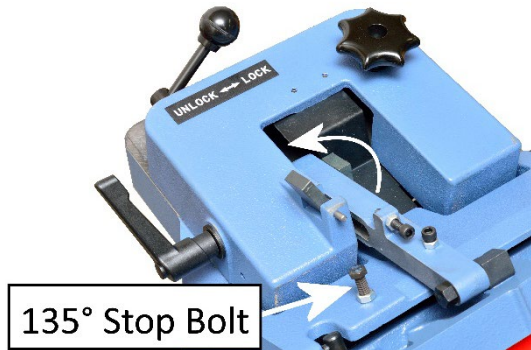

4. Tilt the fence backward and away from the table, until it is stopped by the 135° stop bolt.

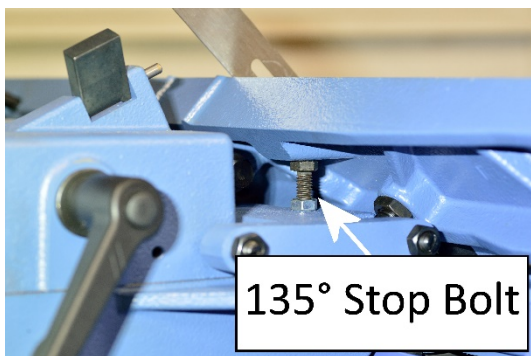

5. Place a protractor against the fence to see if it is stopped at 135 degrees.

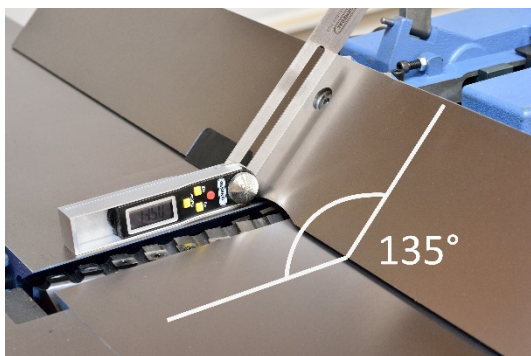

Adjust Belt Tension



CAUTION Belt and pulleys may be hot after operations. Allow components to cool before servicing.

1. Disconnect the jointer from the power source!!
2. Remove the motor access panel and the belt cover.

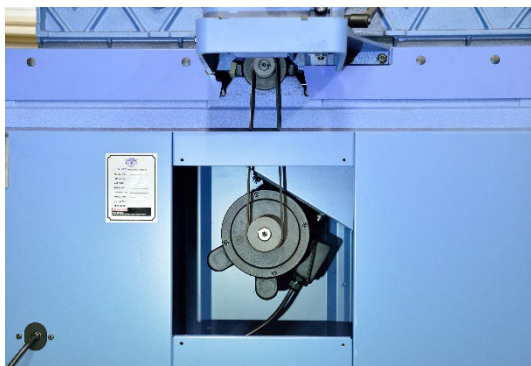
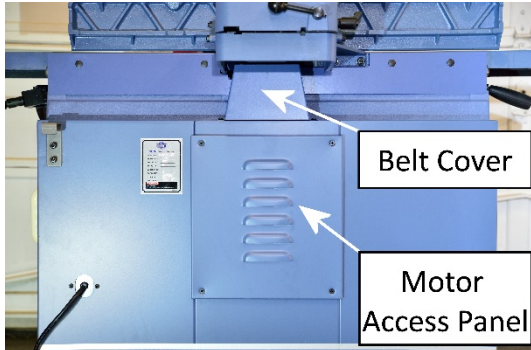

3. Apply moderate pressure on the V-belt midway between the two pulleys. Properly tensioned V-belt should deflect by about 1/4" - 1/2".

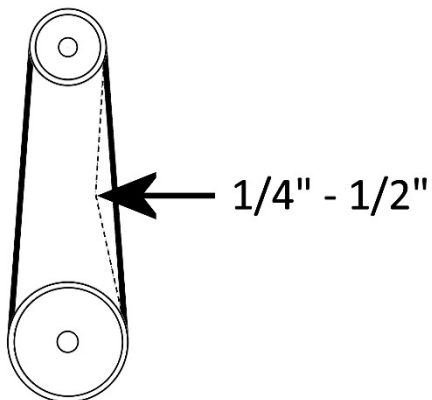

4. If V-belt tension needs to be adjusted, loosen the four motor mounting nuts. Adjust the motor height until proper belt tension is reached, then re-tighten the mounting nuts.

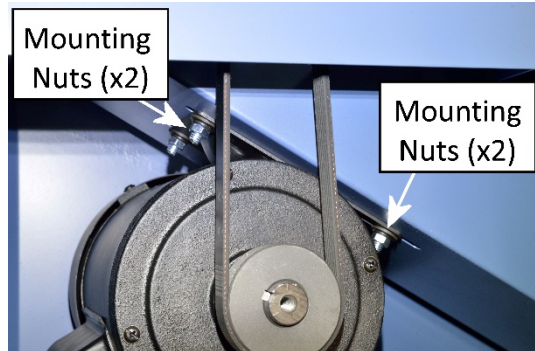

5. If the V-belt needs to be replaced, gradually walk the belt away from the motor and eventually remove it from the pulley.

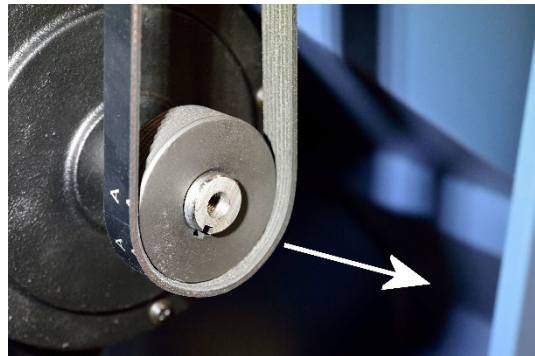

6. Install a new belt and make sure the belts sit into the grooves of pulleys. If the belt is too tight to install, adjust the motor position.
7. Adjust belt tension and re-secure the motor as needed.
8. Reinstall belt cover and motor access panel when maintenance completes.

Align Belt Pulleys

The belt pulleys were aligned in the factory and should not require further adjustments. Check pulley alignment if the motor is repositioned. Also check the pulley alignment if the belt is slipping off the pulleys, or if the belt wears prematurely.

1. **Disconnect the jointer from the power source!!**
2. Remove the motor access panel and the belt cover.

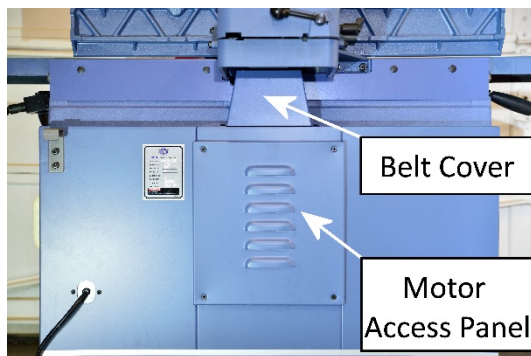

3. Use a straight edge to check the coplanarity of the belt pulleys.
4. Adjustments can be made by shifting the motor pulley. Loosen the set screw with a hex wrench, and the motor pulley can move along the motor shaft by a small amount.

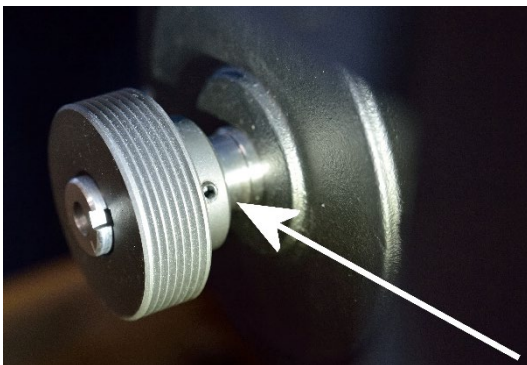

5. Realign the motor pulley and the cutterhead pulley. Retighten the motor pulley locking screws when adjustment is done.
6. If the pulleys are still not coplanar, adjust the motor mount.
7. Reinstall the belt cover and motor access panel when adjustments complete.

Troubleshooting

Mechanical / Electrical Issues

Problem	Possible Cause	Possible Solution
Machine does not start.	Machine is not connected to a power source.	<ol style="list-style-type: none"> 1. Make sure the machine is plugged in, or the power disconnect is at the ON position. 2. Check the electrical panel for a tripped circuit breaker or a blown fuse. 3. Ensure all electrical connections have good contacts.
	Low voltage / current.	Have an electrician repair the power circuit.
	Faulty switch/motor/capacitor.	Contact customer service for further assistance.
Machine stopped during an operation.	Machine trips circuit breaker or blows fuse.	Reconnect the circuit and see the troubleshooting steps "Machine trips circuit breaker, or blow fuses."
Machine trips circuit breaker or blows fuse.	Machine is undersized for the operation.	Reduce the depth of cut and/or feed rate.
	Workpiece moisture level is too high.	Only joint wood with a moisture level below 20%.
	Machine is jammed.	Make sure the cutterhead is not jammed by woodchips. Check dust chute and clear blockages.
	Too much load on a circuit.	Make sure the power circuit is sized for this machine. If the circuit is shared, ensure it is sized to supply power for all items in the circuit.
	Motor/capacitor issue.	Contact customer service for further assistance.
Machine stalls during operation.	Machine is undersized for the operation.	Reduce the depth of cut. Lower feed rate.
	Dull cutters.	Rotate/replace cutter inserts.
	Belt slipping.	Clean belt and pulleys. Adjust belt tension.
	Motor/capacitor issue.	Contact customer service for further assistance.
Outfeed table is stuck/difficult to adjust.	Outfeed table is locked.	Loosen the locking cap screw before adjusting the outfeed table.
Unable to lower infeed table below 1/8"	Depth stop is engaged.	Pull infeed table depth stop knob while lowering the infeed table. NOTICE: Only set depth of cut greater than 1/8" for rabbeting operations.

Problem	Possible Cause	Possible Solution
Table is loose.	There is play in the parallelogram mechanism.	Check the parallelogram mechanism and eliminate any gaps between the eccentric nut, bracket, and shafts. Ensure all eccentric nuts are locked by the set screws, and each set screw is locked by blue Loctite.
Workpiece is caught on the edge of the outfeed table.	Outfeed table is set too high.	Adjust the outfeed table to ensure it is flush with the cutting arc of the cutterhead.
Uneven wear on cutter inserts	One section of cutterhead is used more than another.	Occasionally adjust fence position so the entire cutterhead is utilized.
Machine vibrates excessively or makes unexpected noise.	Damaged cutter inserts.	Replace cutter inserts.
	Machine stands on an uneven floor.	Reposition machine on a flat, level surface.
	V-belt worn, slipping, or hitting belt cover.	Clean belt and pulleys. Adjust belt tension. Replace V-belt if it shows signs of aging.
	Improper motor mounting.	Check and adjust motor mounting.
	Loose components.	Tighten fasteners of the component.
	Worn bearings.	Contact customer service for assistance.

Operation / Quality-Related Issues

Problem	Possible Cause	Possible Solution
Workpiece came out twisted.	Improper feeding.	Use the outfeed table as the reference point for feeding. Apply even pressure and feed rate on the entire workpiece.
	Outfeed table is not in parallel with the cutterhead.	Ensure the outfeed table is in parallel with the cutterhead, and the outfeed/infeed tables are coplanar.
	More passes are needed.	Significantly twisted boards take multiple passes to flatten.
Excessive snipe	Outfeed table too low.	Adjust the outfeed table to ensure it is flush with the cutting arc of the cutterhead.
	Too much downward pressure when feeding the end of the workpiece.	Once the workpiece reaches the outfeed table, use the outfeed table as the reference. Reduce feeding pressure apply to the workpiece that is still on the infeed table.

Problem	Possible Cause	Possible Solution
Chipping	Too much material was removed in one pass.	Reduce the feed rate or the depth of cut.
	Planing across/end grain.	Do not use a jointer to cut across/end grain.
	Damaged cutter.	Rotate/replace cutter insert.
	Cutting against grain; or knots.	Avoid processing workpieces with knots. Cut WITH grain whenever possible. When jointing a workpiece with complicated grain pattern, reduce the depth of cut. Sometimes moistening problematic areas can reduce chipping.
Fuzzy looking finish.	Wood moisture content is too high.	Only process wood with less than 20% moisture content.
	Dull cutter.	Rotate/replace cutter insert.
	Some wood types tend to have fuzzy grain.	Adjust feed rate or the depth of cut. Use sharp cutters.
Glossy looking finish.	Dull cutter.	Rotate/replace cutter insert.
	Cutting depth too shallow.	Increase depth of cut.
Long lines or ridges running along the length of the board.	Chipped cutter.	Rotate/replace cutter insert.
Finished stock has uneven front-to-back thickness.	Cutterhead is not flush with the outfeed table.	Adjust the outfeed table to ensure it is flush with the cutting arc of the cutterhead.
	Inconsistent feeding pressure applied to the workpiece.	Apply even feeding pressure on the workpiece. Keep feed rate consistent.
Finished stock is concave/convex in the middle.	Infeed/outfeed tables are not coplanar.	Ensure the outfeed table is parallel with the cutterhead, and the outfeed/infeed tables are coplanar.

Wiring Diagram

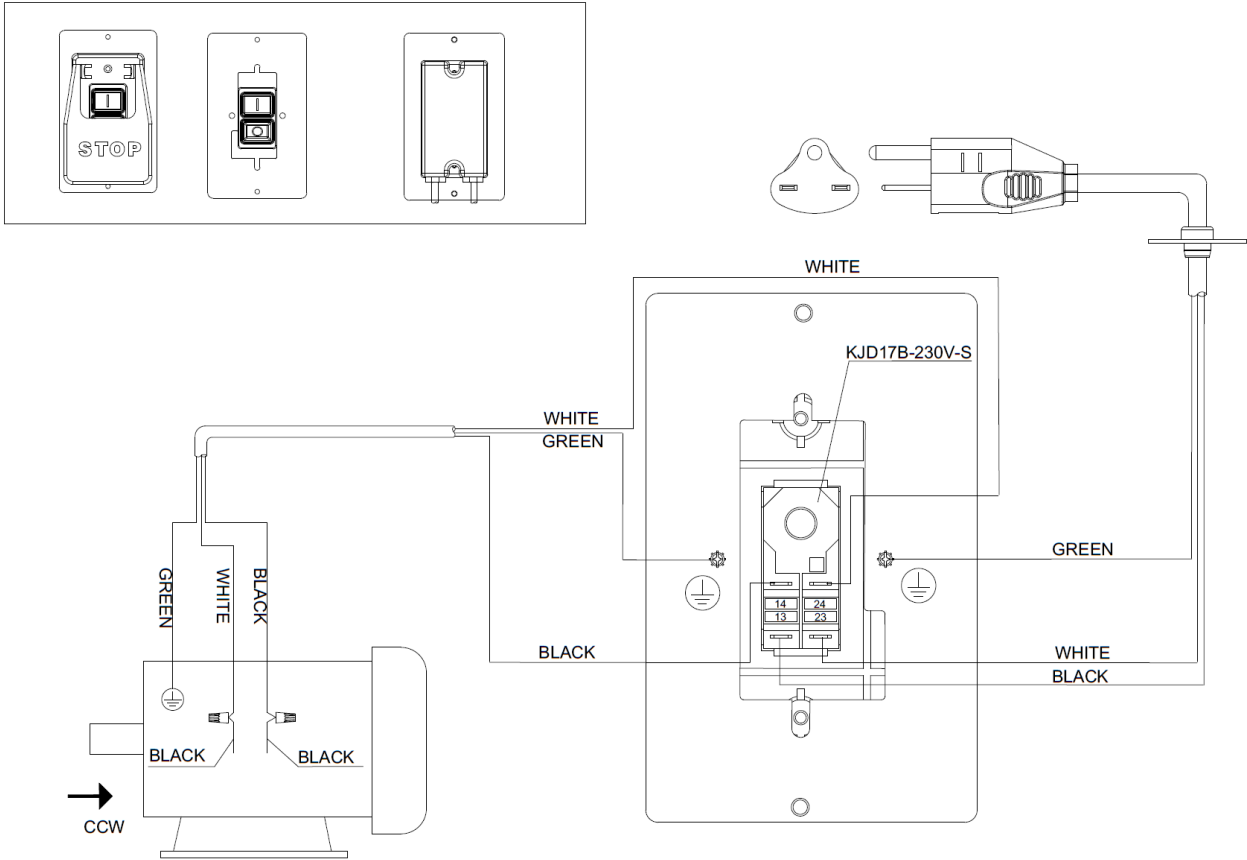

Parts List

Fence Assembly

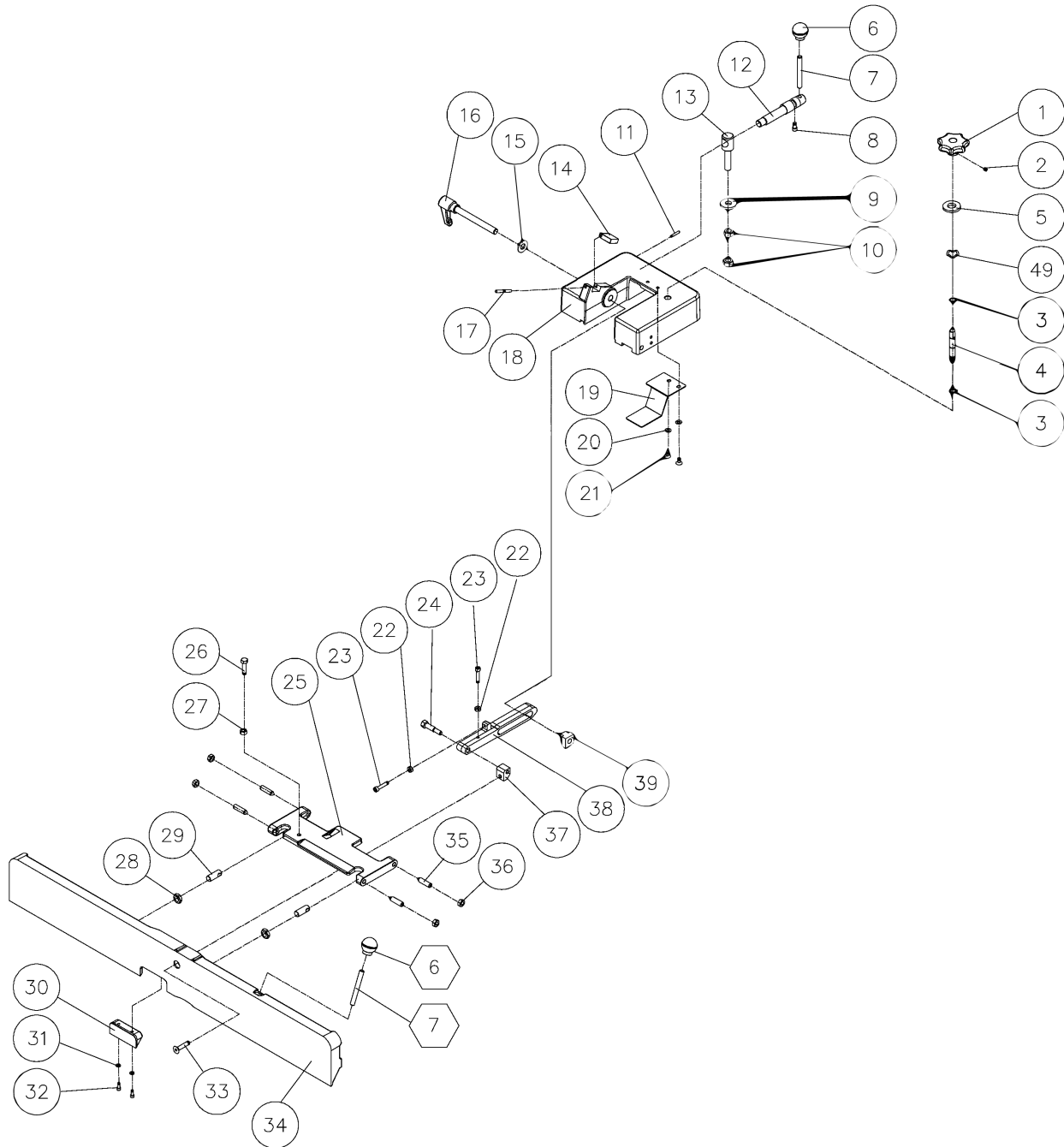
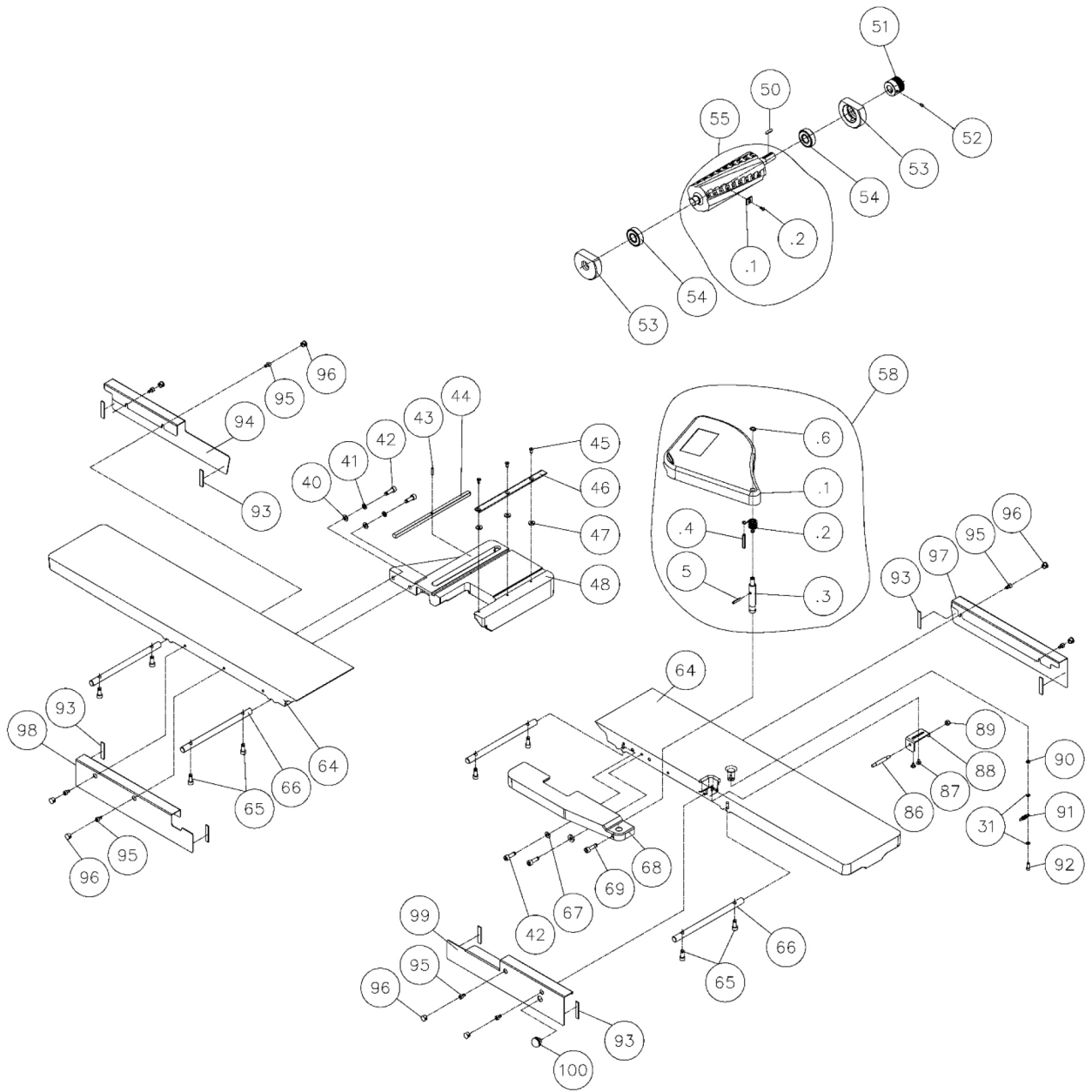
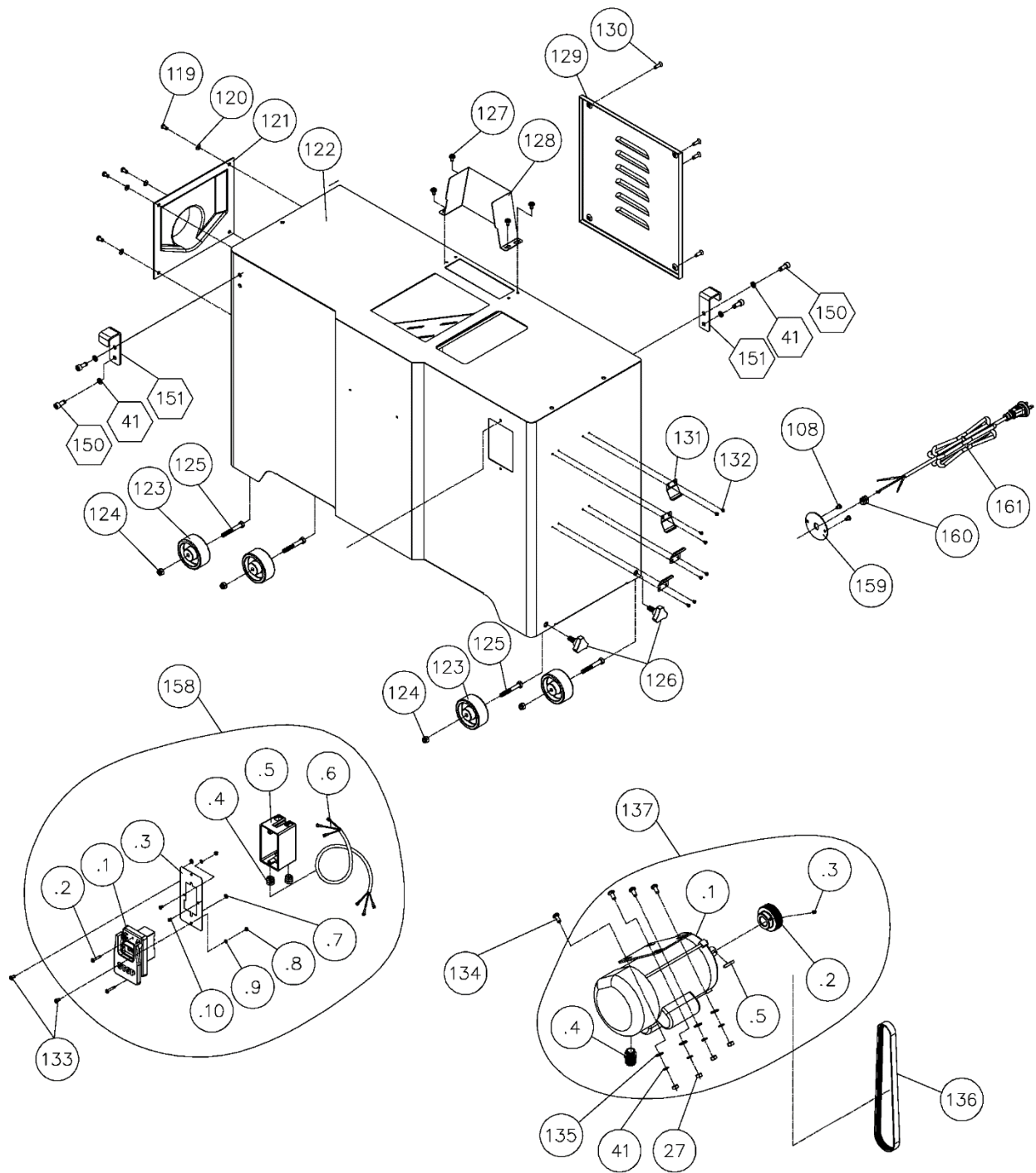

Table and Cutterhead Assembly



Motor and Cabinet



Base Assembly

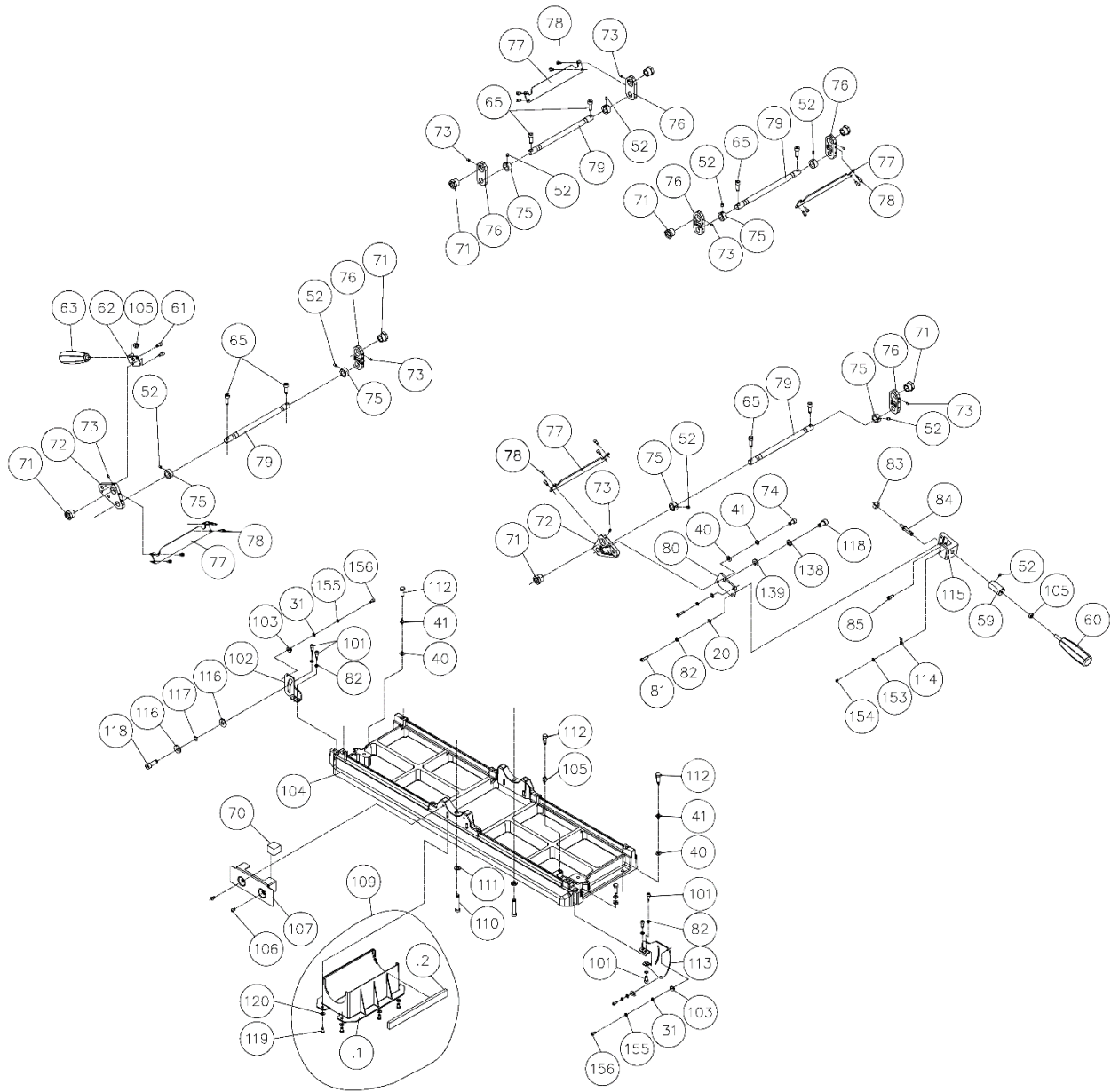

Key	Part Number	Descriptions	Specifications	QTY
1	240080-904	Knob		1
2	001902-109	Set Lock Screw	M6*1.0P*6	1
3	010003-000	S Ring	STW-12	2
4	381336-901	Gear Shaft		1
5	006001-087	Flat Washer		1
6	250372-615	Knob		2
7	360038-901	Shaft for Knob		2
8	003103-102	Cap Screw	1/4"-20NC*1/2"	1
9	172285-905	Flat Washer	13*35*5.0t	1
10	009011-100	Hex. Nut	1/2"-12NC	2
11	011002-106	Spring Pin	4*25	1
12	360074-901	Eccentric Shaft		1
13	360075-901	Cam Lock Stud		1
14	130019-903	Stop Block		1
15	006001-091	Flat Washer	13*28*3.0t	1
16	230035-000	Lock Handle		1
17	360078-000	Pin		1
18	051332-000	Fence Bracket		1
19	170127-901	Safety Plate		1
20	006001-032	Flat Washer	6.6*13*1.0t	4
21	003403-102	Flat Head Screw	1/4"-20NC*1/2"	2
22	009004-200	Hex. Nut	1/4"-20NC	2
23	003103-104	Cap Screw	1/4"-20NC*1-1/4"	2
24	290007-901	Screw		1
25	051313-000	Fence Link		1
26	003003-106	Hex. Screw	5/16"-18NC*1-1/4"	1
27	009005-200	Hex. Nut	5/16"-18NC	5
28	009010-100	Hex. Nut	1/2"-20NF	2
29	360676-901	Pivot Stud		2
30	250462-615	Fence Insert		1
31	006001-009	Flat Washer	5.2*10*1.0t	7
32	003102-102	Cap Screw	3/16"-24NC*1/2"	2
33	003602-101	Flat Head Hex. Screw	5/16"-18NC*1-1/2"	1
34	051331-000	Fence		1
35	230015-901	Set Screw		4
36	009022-100	Hex. Nut	3/8"-16NC	4
37	130008-903	Fence Block		1
38	051334-000	Fence Link		1
39	130383-903	T-Nut (RH Thread)	1/2"-12NC	1
40	006001-049	Flat Washer	8.5*16*2.0t	6
41	006305-100	Spring Washer	8.2*13.7	14
42	000104-108	Cap Screw	M8*1.25P*25	4
43	011002-105	Spring Pin	4*20	1
44	380082-902	Key		1
45	000701-103	Flat Head Hex. Screw	M5*0.8P*12	3

Key	Part Number	Descriptions	Specifications	QTY
46	171841-902	Fence Guide		1
47	006001-034	Flat Washer	6.7*16*2.0t	3
48	051355-000	Fence Slide Bracket		1
49	006722-100	Wavy Washer	WW-19 (19.05*26)	1
50	012003-008	Key	5*5*22	1
51	381409-902	Cutterhead Pulley		1
52	001902-102	Set Lock Screw	M6*1.0P*8	11
53	050095-901	Bearing Housing		2
54	030208-002	Ball Bearing	6204-2NSE	2
55	JG34-12	Cutterhead Assembly		1
55.1	P-15mm 4S	Inserts Sold in Packs of 10	15*15*2.5t	36
55.2	038201-101	Torx Screws	#10-32NF*1/2"	36
55.3	040710-000	Torx Screwdriver	T-25	2
57	250035-629	Push Blocks		2
58	924821-000	Cutterhead Guard Assembly		1
58.1	090020-000	Cutterhead Guard		1
58.2	280281-901	Torsion Spring		1
58.3	361375-901	Pivot Shaft		1
58.4	011004-106	Pin	6*28	1
58.5	011003-105	Pin	5*26	1
58.6	010002-000	S Ring	STW-11	1
59	381428-902	Bushing		1
60	230191-000	Knob		1
61	000102-104	Cap Screw	M5*0.8P*12	2
62	174786-904	Knob Bracket		1
63	230141-615	Knob		1
64	051429-000	Table (infeed or outfeed)		2
65	002601-107	Cap Lock Screw	M8*1.25P*25	16
66	361239-902	Table Shaft		4
67	006001-163	Flat Washer	8.5*19*3t	2
68	051358-000	Rabbeting Table		1
69	003104-104	Cap Screw	5/16"-18NC*1"	1
70	200105-615	Sponge	30*30*22(L*W*H)	1
71	130350-903	Adjusting Bushing		8
72	130351-903	Bushing Plate (3 Holes)		2
73	001901-102	Set Lock Screw	M5*0.8P*8	8
74	000104-104	Cap Screw	M8*1.25P*16	1
75	361241-902	Bushing		8
76	130352-903	Bushing Plate (2 Holes)		6
77	174604-000	Plate		4
78	002603-101	Cap Lock Screw	M5*0.8P*10	16
79	361326-902	Shaft for Knob		4
80	174784-904	Positioning Plate		1

Key	Part Number	Descriptions	Specifications	QTY
81	000103-108	Cap Screw	M6*1.0P*25	2
82	006303-100	Spring Washer	6.5*10.5	7
83	130393-903	Wedged Block		1
84	361370-902	Shaft		1
85	002602-101	Cap Lock Screw	M6*1.0P*12	1
86	361327-902	Shaft		1
87	290028-901	Shoulder Screw		2
88	174603-902	Positioning Plate		1
89	009103-100	Lock Nut	1/4"-20NC	1
90	008004-100	Hex. Nut	M5*0.8P	1
91	280082-000	Tension Spring		1
92	000102-116	Cap Screw	M5*0.8P*15	1
93	200024-615	Foam Pad		8
94	174600-000	Left Rear Cover		1
95	000103-102	Cap Screw	M6*1.0P*10	8
96	042505-000	Plug	HP-13	8
97	174601-000	Right Rear Cover		1
98	174599-000	Left Front Cover		1
99	174781-000	Right Front Cover		1
100	230156-615	Ball Knob	22mm dia*1/4"-20NC	1
101	000103-105	Cap Screw	M6*1.0P*15	5
102	174787-904	Outfeed Table Lock Plate		1
103	174785-904	Positioning Plate		3
104	051441-000	Table Base		1
105	008006-100	Hex. Nut	M8*1.25P	3
106	000801-101	Flat Head Cap Screw	M6*1.0P*10	2
107	174597-000	Cutterhead Front Cover		1
108	000304-101	Philips Screw	M6*1.0P*8	2
109	924665-000	Dust Cover Assembly		1
109.1	251321-615	Dust Cover		1
109.2	200104-615	Dust Cover Sponge	212*10*20mm(L*W*H)	1
110	003111-301	Cap Screw	3/8-24NF*2"	2
111	006306-100	Spring Washer	9.8*17.8	2
112	000003-105	Hex. Bolt	M8*1.25P*25	4
113	174783-904	Infeed Table Lock Plate		1
114	174782-156	Scale Pointer		1
115	310548-911	Bracket		1
116	006003-080	Flat Washer	10.5*23*3.0t	2
117	006703-100	Wavy Washer	WW-10	1
118	000105-101	Cap Screw	M10*1.5P*20	2
119	000304-203	Pan Head Philips Screw	M6*1.0P*12	8
120	006002-032	Flat Washer	6.6*13*1.0t	8
121	250052-615	Dust Port		1
122	174596-000	Cabinet		1
123	250399-615	Wheel		4
124	008306-100	Lock Nut	M8*1.25P	4
125	000003-313	Hex. Screw	M8*1.25P*60	4

Key	Part Number	Descriptions	Specifications	QTY
126	230388-000	Knob Bolt	3-Lobe	2
127	001603-102	Phillip Head Screw w/Flat Washer	M6*1.0P*10/6*13.2*1.0t	4
128	174595-000	Belt Guard		1
129	170445-000	Rear Access Panel		1
130	000403-104	Pan Head Phillips Screw	M6*1.0P*20	4
131	270003-901	Push Block Bracket		4
132	001102-102	Self-Tapping Screw	M4*1.59P*8	8
133	000303-103	Pan Head Philips Screw	M5*0.8P*10	2
134	003801-202	Carriage Bolt	5/16"-18NC*3/4"	4
135	006001-053	Flat Washer	8.5*19*2.0t	4
136	014361-000	V-Belt	300J-7	1
137	JG34-01	4235 Motor Assembly		1
137.1	603168-000	Motor	2HP*220-240V*60HZ*1PH*2P*8A	1
	496272-000	Starting Capacitor	400MFD/125VAC(LAI)(40*90)	1
	496291-000	Running Capacitor	60UF/250VAC(LAI)(40*85)	1
137.2	381410-902	Motor Pulley		1
137.3	001902-102	Set Screw	M6*1.0P*8	1
137.4	021316-000	Strain Relief	MG16A-10B-ST	1
137.5	012202-002	Key	5*5*30	1
138	006307-100	Spring Washer	10.2*18.5	1
139	006001-069	Flat Washer	10*20*3.0t	1
150	000104-106	Cap Screw	M8*1.25P*20	4
151	174695-902	Lifting Hook		2
153	006001-001	Flat Washer	4.3*10*1.0t	1
154	000302-101	Pan Head Philips Screw	M4*0.7P*6	1
155	006302-100	Spring Washer	5.1*9.3	3
156	000102-103	Cap Screw	M5*0.8P*10	3
158.1	821028-002	Switch Assembly	KJD17B-230V-S	1
158.2	000302-209	Pan Head Philips Screw	M4*0.7P*25	2
158.3	174365-902	Switch Backing Plate		1
158.4	020003-000	Strain Relief R type	SB7R-3	2
158.5	250480-615	Switch Box		1
158.6	473003-005	CSA Cable	SJT 14AWG*3C*850mm	1
158.7	570695-000	Ground Sticker		2
158.8	008002-200	Hex. Nut	M4*0.7P(7B*3.2H)	2
158.9	006501-100	Toothed Washer	4.3*8.5(BW-4)	2
158.10	000302-101	Pan Head Philips Screw	M4*0.7P*6	2
159	174239-904	Backing Plate		1
160	020003-000	Pan Head Philips Screw	M4*0.7P*6	2
161	453012-013	CSA/UL Molded Plug	SJT 14AWG*3C*2600mm	1

Spare Parts

Part Number	Descriptions	Specifications	QTY
P-15mm 4S	Insert	15*15*2.5t	5
038201-101	Torx Screw	#10-32UNF*1/2"	10

Tools for Assembly

Part Number	Descriptions	Specifications	QTY
040710-000	Torx Screwdriver	T-25	2
Local Purchase	Hex Wrench	3mm	1
Local Purchase	Hex Wrench	6mm	1
Local Purchase	Open End Wrench	8mm/10mm	1
Local Purchase	Open End Wrench	11mm/13mm	1

Warranty and Service

Oliver Machinery makes every effort to assure that its equipment meets the highest possible standards of quality and durability. All products sold by Oliver Machinery are warranted to the original customer to be free from defects for a period of two (2) years on all parts excluding electronics and motors which are warranted for one (1) year from the date of shipment. Oliver Machinery's obligation under this warranty shall be exclusively limited to repairing or replacing products or parts or components, at its sole option, determined by Oliver Machinery to be defective. Oliver Machinery shall not be required to provide other form of indemnity or compensation including but not limited to compensatory damages.

This warranty does not apply to defects due to direct or indirect misuse, abuse, negligence, accidents, unauthorized repairs, alternation outside our facilities, lack of maintenance, acts of nature, or items that would normally be consumed or require replacement due to normal wear and tear.

OTHER TERMS

To obtain and exercise the warranty right, please call 800-559-5065 or fill out warranty request form online at www.olivermachinery.net.

Warranty parts are shipped via Parcel or Ground. Additional charges will occur and charge to customers if express shipping is required.

DISCLAIMER

Under no circumstances shall Oliver Machinery be liable for death, personal or property injury, or damages arising from the use of its products.

Oliver Machinery reserves the right to make changes without prior notice to its products to improve function or performance or design.

FOR MORE INFORMATION

If you need assistance or have questions beyond what is covered in the scope of this warranty information, please call 800-559-5065 or email us at info@olivermachinery.net.

Appendix

US Standard – Metric Conversion Chart

Fractions	Decimal In.	Millimeters
1/64	.0156	.396
1/32	.0312	.793
3/64	.0469	1.190
1/16	.0625	1.587
5/64	.0781	1.984
3/32	.0937	2.381
7/64	.1094	2.778
1/8	.125	3.175
9/64	.1406	3.571
5/32	.1562	3.968
11/64	.1719	4.365
3/16	.1875	4.762
13/64	.2031	5.159
7/32	.2187	5.556
15/64	.2344	5.953
1/4	.25	6.350
17/64	.2656	6.746
9/32	.2812	7.143
19/64	.2969	7.540
5/16	.3125	7.937
21/64	.3281	8.334
11/32	.3437	8.731
23/64	.3594	9.128
3/8	.375	9.525
25/64	.3906	9.921
13/32	.4062	10.318
27/64	.4219	10.715
7/16	.4375	11.112
29/64	.4531	11.509
15/32	.4687	11.906
31/64	.4844	12.303
1/2	.5	12.700

Fractions	Decimals In.	Millimeters
33/64	.5156	13.096
17/32	.5312	13.493
35/64	.5469	13.890
9/16	.5625	14.287
37/64	.5781	14.684
19/32	.5937	15.081
39/64	.6094	15.478
5/8	.625	15.875
41/64	.6406	16.271
21/32	.6562	16.668
43/64	.6719	17.065
11/16	.6875	17.462
45/64	.7031	17.859
23/32	.7187	18.256
47/64	.7344	18.653
3/4	.75	19.050
49/64	.7656	19.446
25/32	.7812	19.843
51/64	.7969	20.240
13/16	.8125	20.637
53/64	.8281	21.034
27/32	.8437	21.431
55/64	.8594	21.828
7/8	.875	22.225
57/64	.8906	22.621
29/32	.9062	23.018
59/64	.9219	23.415
15/16	.9375	23.812
61/64	.9531	24.209
31/32	.9687	24.606
63/64	.9844	25.003
1.0	1.	25.400



Oliver Machinery is always adding new Industrial Woodworking products to the line.

For complete, up-to-date product information, visit us online at:

WWW.OLIVERMACHINERY.NET

or call toll free 1-800-559-5065

**** SAVE THIS MANUAL FOR FUTURE REFERENCES. ****