

Planer

Model 10014

Owner's Manual

For Models Manufactured Since 09/2023



Oliver Machinery
1-800-559-5065
921 Thomas Ave SW, Renton WA 98057

info@olivermachinery.net
WWW.OLIVERMACHINERY.NET

Stock Number:
10014.201 Manual
Version: 1.2.0



READ AND UNDERSTAND ALL INSTRUCTIONS IN THIS MANUAL BEFORE ATTEMPTING TO ASSEMBLE OR OPERATE THE MACHINE.

FOLLOW THE INSTRUCTIONS AND THINK SAFETY!

THE OWNER OF THIS MACHINE IS SOLELY RESPONSIBLE FOR THE SAFETY OF ANYONE USING THIS MACHINE. SUCH RESPONSIBILITY INCLUDES BUT NOT LIMITED TO:

- **PROPER ASSEMBLY, OPERATION, INSPECTION, MAINTENANCE, AND RELOCATION OF THE MACHINE.**
- **PROPER TRAINING FOR THE OPERATORS AND ENSURES THIS MANUAL IS AVAILABLE AT ALL TIMES.**
- **USAGE AUTHORIZATION.**
- **USAGE OF SAFETY AND PROTECTION DEVICE.**

OLIVER MACHINERY DISCLAIMS ANY LIABILITY FOR MACHINES THAT HAVE BEEN ALTERED OR ABUSED. OLIVER MACHINERY RESERVES THE RIGHT TO EFFECT AT ANY TIME, WITHOUT PRIOR NOTICE, THOSE ALTERATIONS TO PARTS, FITTINGS, AND ACCESSORY EQUIPMENT WHICH THEY MAY DEEM NECESSARY FOR ANY REASON WHATSOEVER.

**** SAVE THIS MANUAL FOR FUTURE REFERENCES. ****

PROP65 NOTICE

WARNING: Drilling, sawing, sanding or machining wood products can expose you to wood dust, and/or other chemicals known to the State of California to cause cancer, birth defects or other reproductive harm.

Some examples of these chemicals are:

- Lead from lead-based paints.
- Crystalline silica from bricks, cement and other masonry products.
- Arsenic and chromium from chemically-treated lumber.

Avoid inhaling wood dust and other harmful chemicals. Use a dust mask and/or other safety devices for personal protection.

For more information go to <http://www.P65Warnings.ca.gov/wood>

Table of Contents

Introduction	6	Assembly	22
Specifications	7	Installing Height Adjustment Handwheel	23
Quick View	7	Installing Dust Hood	23
Product Dimensions	7	Installing Extension Tables	24
Shipment Info	7	Dust Collection	26
Electricals	7	Wiring and Grounding	26
Motor	8	Wiring Instructions	26
Planer Capacity and Performance	8	Break-in Period	26
Cutterhead and Headstock	8	Controls and Components	27
Measurements	8	ON / OFF Switches	27
Table	9	Cutterhead Height Adjustment	27
Safety	9	Cutterhead Height Scale	27
Others	9	Digital Readout (DRO)	Error! Bookmark not defined.
Identification	10	Feed Rate Control	Error! Bookmark not defined.
Safety	13	Components for Planing Wood	Error! Bookmark not defined.
General Safety Guidelines	13	Test Run	30
Safety Guidelines Specific to Planer	14	Operation	31
Electricals	16	Step 1: Preparation	31
Minimum Circuit Size Required for Model 10014 Planer	16	Step 2: Setting Depth of Cut and Feed Rate	32
Grounding	16	Step 3: Select Feed Direction	33
Electrical Wiring	16	Step 4: Planing Wood to Desired Thickness	33
Setup	18	Common Cutting Problems	35
Shop Preparation	18	Snipe	35
Space Requirement	18	Chipping	35
Load Limits	18	Indentation	35
Electricals	18	Fuzzy Grain	35
Lighting	18	Accessories	36
Safety Labels	18	Cutter Inserts	36
Dust Collection	18	Touchup Paint	36
Receiving	19	Maintenance	37
Unboxing	19	Maintenance Schedule	37
Inventory	20	Lubrication Schedule	37
Removing Machine from Crate	21	Instructions for Maintenance and Adjustments	39
Cleaning	22		

Remove Planer Top Cover	39
Adjust Chip Deflector Clearance	39
Service Cutterhead and Rotate Cutter Inserts	40
Adjust Belt Tension	41
Adjust Table Chain Tension	42
Adjust Table Roller Height	42
Adjust Cutterhead/Feed Roller Height Offset	43
Adjust Feed Roller Tension	46
Adjust Cutterhead Height Scale	47
Anti-Kickback Fingers Inspection	47
Troubleshooting	48
Wiring Diagram	51
Parts List	52

Table Assembly	52
Cabinet Assembly	53
Motor Mount Assembly	54
Headstock Assembly	55
Gearbox Assembly	56
Cover and Dust Port Assembly	Error!
Bookmark not defined.	
Maintenance Record	62
Notes	63
Warranty and Service	64

Introduction

Thank you for choosing Oliver! This manual contains important information on how to safely set up, operate, and maintain this machine. Please take the time to read through this manual, and make sure you understand all the instructions.

While this manual may provide tips on optimizing the result of your workpiece, the manual is not intended as a substitute for formal woodworking training. If you need to know how to safely perform an operation, please consult knowledgeable and qualified sources before proceeding further.

We made every effort to keep this manual up-to-date. Instructions, specifications, drawings, and photographs in this manual should match the machine delivered. If you find any differences, or anything that seems confusing in this manual, or some instructions are not available, please check our website for an updated version:

WWW.OLIVERMACHINERY.NET/MANUALS

Alternatively, you can contact our Technical Support for help:

1-800-559-5065

Before calling, please note down the manufacture date and serial number of the machine. You can find the information on a nameplate located on machine cabinet below the power switch. This information is needed to provide proper technical support, and to determine if an updated manual is available for your machine.

Please let us know how well this manual serves you. If you have any suggestions, please call the number above or email us at:

info@olivermachinery.net

We love to hear from our customers and make improvements.

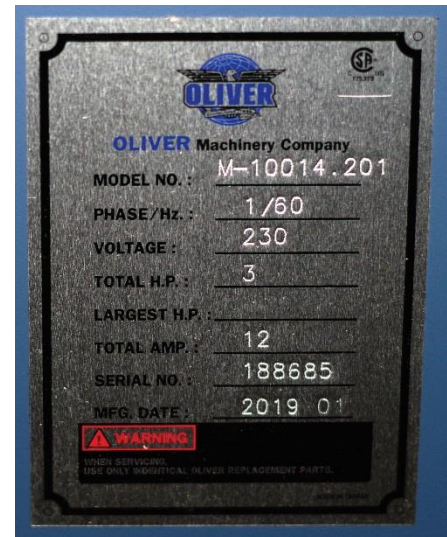

Specifications

Quick View

Model	10014 Planer
Stock Number	10014.201
Motor	TEFC Induction Motor 3HP, 230V, 1Ph
Max. Stock Width	15"
Max Depth of Cut	1/8" (Full width) 3/16" (Stock less than 8" wide)
Dimensions	47-1/2"(L) x 29"(W) x 47"(H)
Footprint	21"(L) x 22"(W)
Fully Assembled Weight	401 lbs.
Warranty	1 Year (Motor and electronics) 2 Years (All other parts)

Product Dimensions

Width x Depth x Height (Fully Assembled)	47-1/2"(L) x 29"(W) x 47"(H)
Footprint	21" (L) x 22"(W)
Fully Assembled Weight	401 lbs.

Shipment Info

Type	Wood Crate with Pallet Base
Content	Planer with Included Accessories
Dimensions	32 (L) x 30"(W) x 49-1/2"(H)
Weight	470 lbs.
Approximate Setup Time	60 minutes
Must Ship Upright	YES
Stackable	NO

Electricals

Power Requirement	230V, 1Ph, 60Hz
Full Load Current Rating	12A
Recommended circuit size	20A
Power Switch Type	Magnetic switch with overload protection.
Connection Type	7' 14 AWG Cord included. Electrical hookups required.
Overload Protection	Equipped

Motor

Motor Type	TEFC Induction Motor
Horsepower	3HP
Speed	3450 RPM
Efficiency / Power Factor	75% / 98%
Power Transfer Mechanism	Poly V-belt and pulleys
Bearing type	Permanently sealed ball bearing

Planer Capacity and Performance

Maximum Stock Width	15"
Maximum Depth of Cut	3/16" (Stock less than 6" wide) 1/8" (Full Width)
Maximum Stock Thickness	6"
Minimum Stock Thickness	3/16"
Minimum Stock Length	6"
Feed Rate	16/20 FPM

Cutterhead and Headstock

Cutterhead Type	Helical
Cutterhead Diameter	2-5/8"
Cutterhead Speed	5000 RPM
Number of Cutter Inserts	52
Number of Rows of Cutter Inserts	4
Cutter Insert Type	Four-sided, indexable German made carbide
Cutter Insert Diameters	15mm x 15mm x 2.5mm
Cutter Blade Angle	30 degree
Cutter Insert Screw Tensioning Torque	50-55 lbs.-inch
Infeed Roller Type	Steel
Outfeed Roller Type	Rubber
Headstock Height Change Per Each Turn of Handwheel	Approx. 0.6" / 1.5mm

Measurements

Measurement Units	Inch/mm
Measurement Devices	Wixey Digital Readout
Resolution	1/32"/0.002"/0.05mm
Accuracy	+/- 1/250"/0.004"/0.1mm
Backup Measurement Device	Standard headstock height scale installed.

Table

Table Dimensions	47-1/2" x 15" (With infeed/outfeed table) 19-1/2" x 15" (Without infeed/outfeed table)
Table Height Above Ground	30-1/4"
Material	Precision ground cast iron
<i>Bed Roller</i>	Two
<i>Extension Table Weight</i>	21 lbs.

Safety

Number of Dust Ports	1
Dust Port Size	4"
Minimum CFM Required	600 CFM
Sound Rating @ 2' distance	85 dB

Others

Serial Number Location	On machine cabinet below the safety label.
<i>Spare Parts Included</i>	10 Cutter inserts and compatible torx screws.
Certification	CSA 175370
Country of Origin	Taiwan

Identification

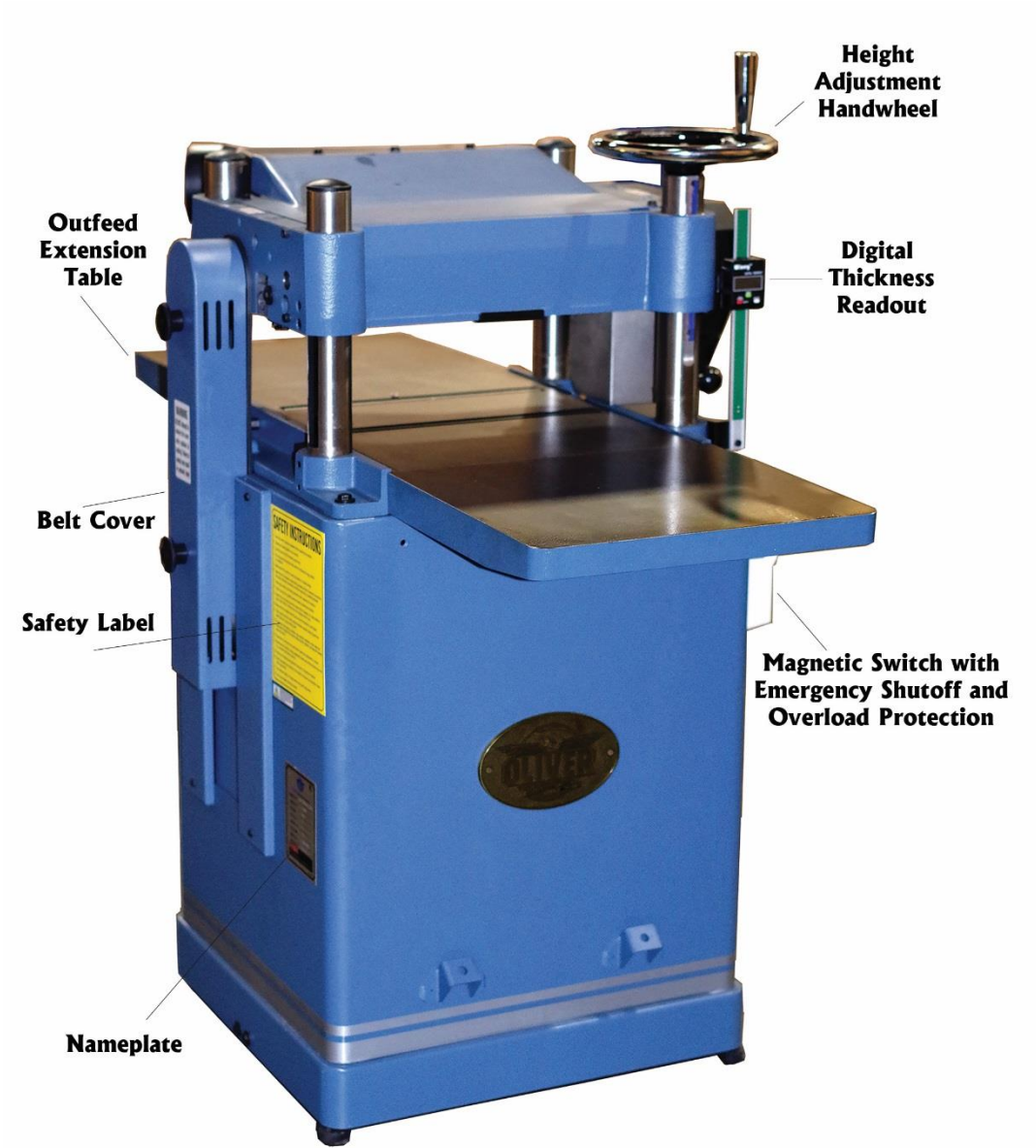

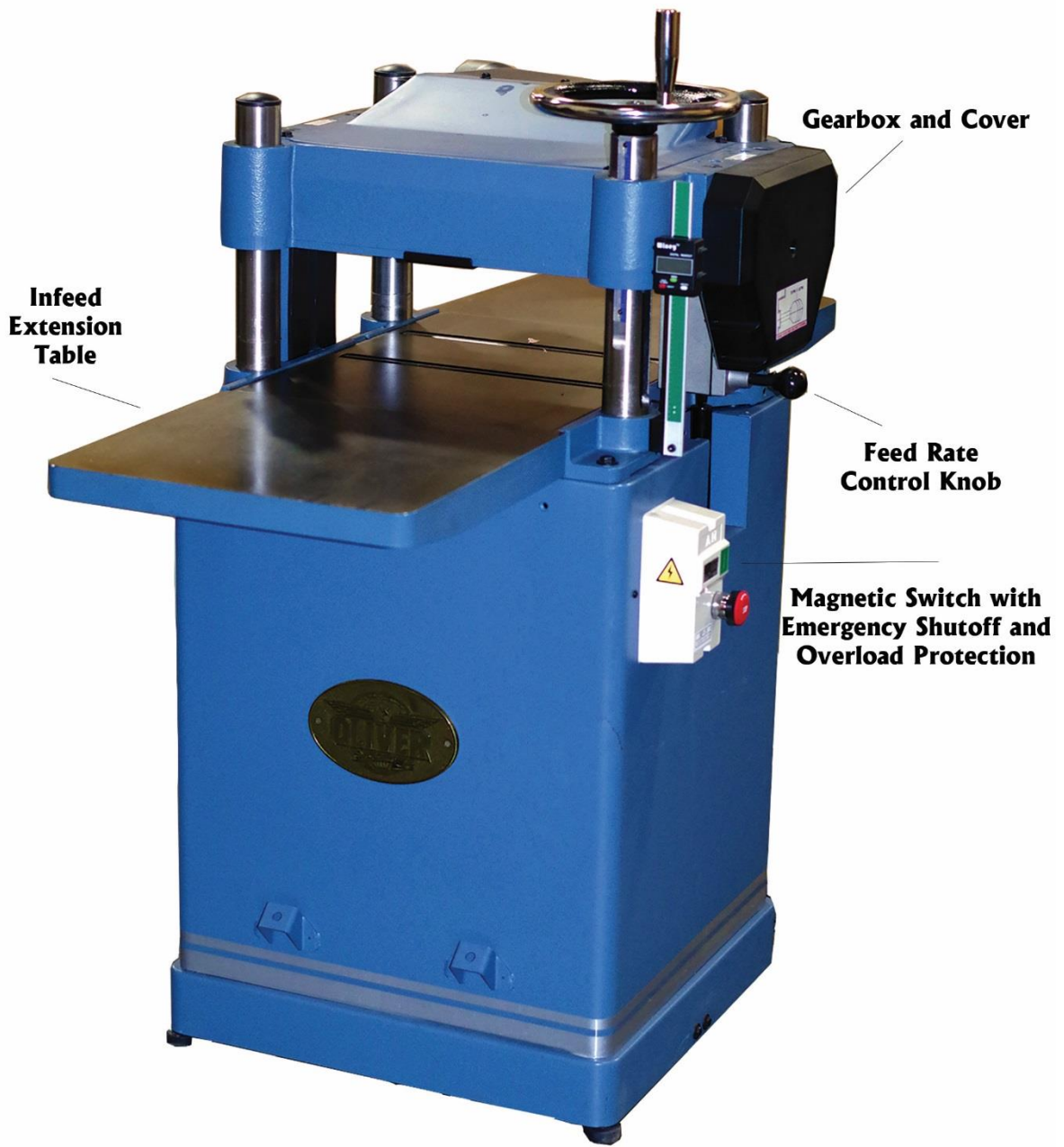





Dust Port

**Motor Access
Panel**

**Mobile Base Caster
Locking Knobs**

Safety

Oliver Machinery has made every attempt to provide a safe, reliable, easy-to-use piece of machinery. Safety, however, is ultimately depending on the individual machine operator. **Before operating this machine, please become familiar with the following safety labels and guidelines.**

 DANGER	This indicate an imminent hazardous situation which, if not avoided, WILL cause death or serious injury.
 WARNING	This means if the warning is not taken seriously, it CAN cause death or serious injury.
 CAUTION	This mean if the precaution is not taken, it MAY cause minor or moderate injury.
IMPORTANT	This is a tip about proper operation of the machine to avoid machine damage.

General Safety Guidelines

1. **FAMILIARIZE** yourself with all safety instructions found in this manual. Know the limitations and hazards associated with this machine. Do not operate / service this machine until you are properly trained.
2. **ELECTRICAL GROUNDING**, when done properly, reduce the risk of electrocution, shocks and fire. Make certain that the machine frame is electrically grounded and that a ground lead is included in the incoming electrical service. In cases where a cord and a plug are used, make certain that the grounding plug connects to a suitable ground. Follow the grounding procedure indicated in the electrical code of your area.
3. **DISCONNECT** the machine from power before performing any service, maintenance, or adjustments. A machine under repair should be RED TAGGED to show it should not be used until the repair is complete.
4. **EYE PROTECTION**: Always wear an approved safety face shield, goggles, or glasses that complies with ANSI Z87.1 and CSA Z94.3 standards. Common eyeglasses are not safety glasses, and may not provide adequate protection.
5. **EAR PROTECTION**: Use hearing protective devices where the noise exceeds the level of exposure allowed in Section 1910.95 of the OSHA Regulations. When in doubt, use it.
6. **OTHER PERSONAL PROTECTION**: Before operating the machine, remove tie, rings, watch and other jewelry. Roll up sleeves above the elbows. Remove all loose outer clothing and confine long hair. Protective type footwear should be used. Do not wear gloves unless it is instructed to perform particular step(s) in the manual.
7. **GUARDS**: Keep the machine guards in place for all applicable operations. If any guards are removed for maintenance, DO NOT OPERATE the machine until the guards are reinstalled. Check clearance between the guards and the cutter before starting the machine.
8. **WORKPLACE SAFETY**: Keep the floor around the machine clean. Scrap material, saw dust, oil and other liquids increase the risk of tripping or slipping. Be sure to clean up the table before starting the machine. Make certain the work area is well lighted and that a proper exhaust system is used to

minimize dust. Use anti-skid floor strips on the floor area where the operator normally stands and mark off machine work area. Provide adequate work space around the machine.

9. **ACCESS CONTROL** should be enforced so only trained personnel can access the work area and operate the machine. Use childproof power switch when applicable.
10. **STAY ALERT** at all times. Do not operate this machine while under the influence of drugs/alcohol, or when not feeling well.
11. **REPLACEMENT PARTS:** Use only genuine Oliver Machinery replacement parts and accessories recommended for this machine. Generic parts made by other manufacturers may create a safety hazard, and WILL void the factory warranty and other guarantees.
12. **PROPER USE:** Do not use this machine for other than its intended use. If used for other purposes, Oliver disclaims any real or implied warranty and holds itself harmless for any injury or damage which may result from that use.

Safety Guidelines Specific to Planer

Before Work Begin:

1. **USE ONLY NATURAL, SOLID WOOD.** Do not plane any material such as plywood, MDF, OSB, laminate or anything that can disintegrate during operation. Do not plane treated lumber or anything that contains harmful chemicals, as this will spread wood dusts that contain such harmful chemicals. Do not attempt to plane workpiece with loose knots or with any other foreign materials.
2. **CHECK CUTTER INSERTS:** Make sure cutter inserts are sharp, clean, and free from damages. Forcing dull/damaged cutter inserts to work invites accidents, and lowers the quality of the finish. Use recommended amount of torque to securely fasten all inserts onto the cutterhead.
3. **SERVICING CUTTER INSERTS:** Wear heavy duty leather clothes to protect your hands when installing new cutter inserts or rotating the existing ones. Ensure the cutterhead is thoroughly clean before installing the insert. Debris between the cutter insert and the platform can create uneven pressure, causing the insert to break, and body injuries may occur.
4. **SUPPORT LONG WORKPIECE** with auxiliary stock feeding rollers/tables. This will help avoiding injuries and improve the quality of finish.

When Planning:

1. **DUST COLLECTION SYSTEM** is required for this planer. Please make sure the system is on and provide enough suction before operation begins.
2. **KICKBACK** happens when a workpiece is ejected, usually towards the infeed side of the planer, during the operation. **This can cause serious injuries or even death.** This planer is equipped with metal anti-kickback fingers to reduce the risk of kickback. Make sure they are clean and moving freely before operation. Even with this safety device installed, kickback can still happen due to workpiece quality, grain orientation and many factors. Operator should be cautious about possible kickback.
 - **ALWAYS** wear proper protection device and stay away from the line-of-fire to avoid kickback related accidents.
 - **NEVER** look inside the planer during operation.
 - **NEVER** plane boards that are shorter than 6" as mentioned in the specifications.
3. **PROPER WORKPIECE FEEDING** avoids kickback. Never start the machine with the workpiece engaging the cutterhead. Never start feeding until the planer has reached its full speed. Ensure there is proper gripping force from the feeding rollers when passing through a workpiece.
 - **NEVER** force a workpiece through the planer. Make adjustments as needed.
 - **ONLY** plane one board at a time.
 - For twisted workpieces, use a jointer to face joint the bottom side of the workpiece before planning.
4. **STUCK WORKPIECE** should be removed only after the planer is powered off, and the cutterhead comes to a complete stop. Do not use hands or push sticks to force feed a workpiece through the planer, as it can result in severe injuries and/or machine damage.
5. **DEPTH OF CUT SETTINGS:** Never exceed the designed maximum depth of cut capacity found in the specification. Failing to comply can cause machine damage and injuries. Consider the hardness of the workpiece when setting the depth of cut, as harder wood types increase the workload of the planer.

After Operation

1. **STOP THE MACHINE** if the operator leaves the machine for any reason.
2. **WAIT** until the machine comes to a complete stop.
3. **CLEAN UP** the work area before departure.

Electricals



WARNING

All electrical work must be done by a qualified electrician, and must meet the electrical code in your area.

Minimum Circuit Size Required for Model 10014 Planer

Stock Number	Minimum Circuit Size Required
10014.201	20A

Please ensure the electrical circuit for this machine meets the minimum circuit size requirement. Minimum circuit size requirement applies to a dedicated circuit which provides power to one 10014 Planer. If more machines are sharing the same circuit, consult a qualified electrician to ensure the designated circuit is properly sized for safe operation.

If a circuit is available, but not meeting the minimum circuit size requirement listed above, a new circuit must be installed for this machine.

Grounding



WARNING

Improper grounding can cause electric shock, fire, and equipment damage.

Proper grounding reduces the risk to the operator in the event of electrical malfunction or breakdown. This machine must be connected to the grounding conductor when available, and all grounding connections must meet or exceed the electrical code requirements in your area. Furthermore, all grounds must be verified and must meet or exceed the electrical requirement of the machine. If grounding is not available. Consider the use of a GFCI protection device as an alternative, if this complies with the electric code in your area.

Electrical Wiring

This machine is not pre-wired with a plug. A 7-foot long 14 AWG cord is provided for connecting this machine to a power source. If you plan to connect the machine directly to the electrical panel (“Hardwiring”). Please ensure there is a readily accessible electrical disconnect near the machine. Refer to section “Wiring Diagram” for wiring your machine to a power source.





If you choose to connect this machine with a plug and a cord, please use a UL/CSA listed plug. If you need an extension cord to connect to the power outlet, select a durable cord type with high temperature rating (90C° or above). Both plug and power cord must be sized to meet the amperage requirement of your machine.

Minimum cord size (AWG) required based on amperage draw and length of the cord:

<i>Amps</i>	Power Cord Length				
	25 feet	50 feet	75 feet	100 feet	> 100 feet
< 5	16	14	14	14	NR
5 to 8	14	14	14	12	
8 to 12	14	14	12	10	
12 to 15	12	12	10	10	
15 to 20	10	10	10	NR	
21 to 30	10	NR	NR	NR	

*NR: Not Recommended

 WARNING	<p>Use properly sized wires that meet or exceed the power requirement of your machine. Using undersized wires may cause overheating and increase the risk of fire and machine damage.</p>
---	--

 WARNING	<p>Improper copper-aluminum wire connection is a fire hazard. If the power circuit available uses aluminum wires, use certified CU/AL wire connectors.</p>
---	---

Setup

Shop Preparation

Space Requirement

The dimensions of this machine are 47-1/2" (L) x 29" (W). You will need additional spaces for manipulating your workpiece, electrical connection and dust collection.

Load Limits

This machine has a shipping weight of 470 lbs., and a net weight of 401 lbs. Please ensure all lifting tools and building structures have adequate load capacity, for transporting and supporting the total weight of this machine, the operator, and related items.

Electricals

Ensure a properly sized circuit and an electrical terminal are available nearby the machine. If the machine is to be hardwired, there must be a readily accessible power disconnect nearby, so that the machine can be disconnected from power source for servicing and adjustments. If the machine is to be connected with a cord and a plug, please ensure a matching outlet is installed nearby the machine.

Please refer to the "Electricals" section in this manual for details regarding electrical requirements and safety instructions.

Lighting

Adequate lighting is needed for operating this machine. Overhead, non-glare lighting should be installed near the work area.

Safety Labels

If this machine introduces a new safety hazard to your work place. Please display proper warning signs in highly visible location(s).

Dust Collection

Wood dusts created by this planer is a health hazard. Connect a dust collection system to this machine. Check the air suction regularly to ensure the pipes are not jammed.

Dust masks should be available for using the planer.

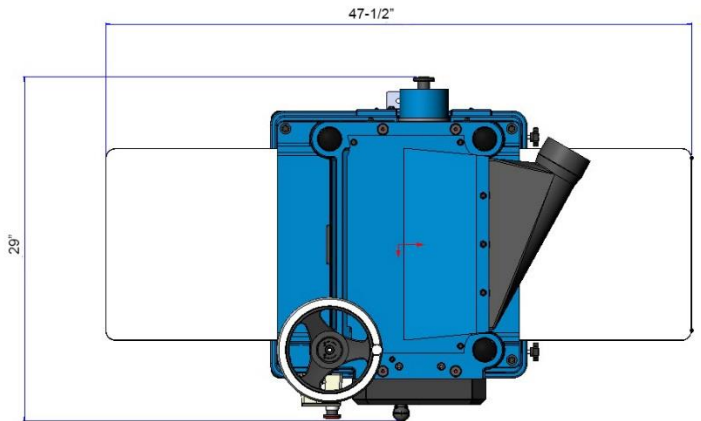

CAUTION

Use a dust collection system that is rated above 600 CFM. Doing so improves air quality in the workplace, and protects the machine from jamming.

Piping of dust collection system introduces additional air resistance, and decreases the effective CFM measured at the dust ports. Ensure there is significant suction at the dust port, so dust and debris can be effectively removed from the machine.

Receiving

Your shipment should come with one wood crate. Upon receiving your shipment, check for any significant damages before signing the delivery confirmation.

IMPORTANT

If items are damaged, please call us immediately at **1-800-559-5065**



CAUTION

You may need to remove strapping that is used for securing your package. Strapping may spring back violently when released and cause injury. Always wear safety goggles and gloves for this task.

Moving Machine into the Shop

Your machine will be delivered by freight service, and it will be left outside of your workshop by default. On the day of delivery, please be sure help is available to move the machine to its final location.



WARNING

10014 Planer has a gross weight of 470 lbs. and a net weight of 401 lbs.

Safe moving techniques and proper lifting equipment required, or serious personal injury may occur.



WARNING

Your shipment may be secured by the straps. Do not lift your shipment by the strap. They are not designed to hold the total weight of your shipment. They may snap without warning and cause serious injury and machine damage.

Unboxing

Upon removing the crate cover, you should find a planer that is mostly assembled, and three paper boxes that contain all the accessories. Everything is covered by a plastic bag.



Inventory

Carefully unwrap the packaging and make sure all components are included in the shipment. Lay out all the items received and inventory them.

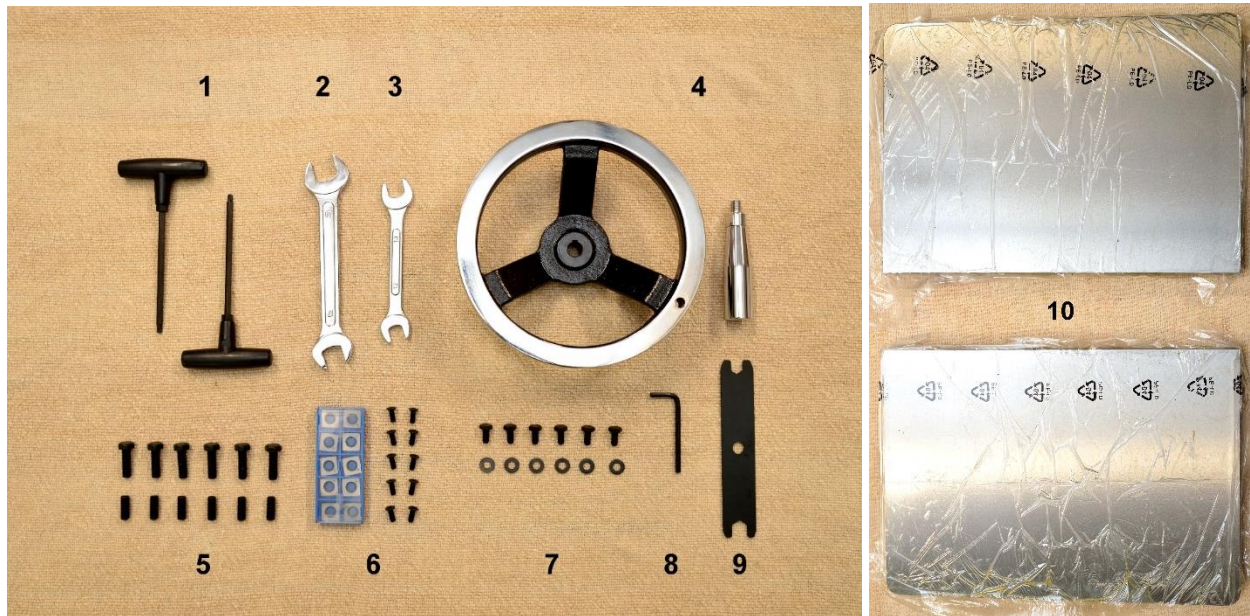

Item	Description	Quantity
1	T-Handle Torx Drivers (T-25)	2
2	17/19mm Wrench	1
3	12/14mm Wrench	1
4	Height Adjustment Handwheel and Handle (Nut and label not shown)	1
5	Fasteners for Extension Table: Hex Bolt (M8*1.25P*25) Set Screw (M8*1.25P*20)	6 each
6	Spare Cutter Inserts and Torx Screws	10 each
7	Fasteners for Dust Port: Socket Head Cap Screw (M6*1.0P*12) Washer	6 each
8	4mm Hex Wrench	1
9	10/13mm Wrench	1
10	Cast Iron Extension Tables	2
11	4" Dust Hood (Not shown in the picture)	1

NOTICE: If you cannot find the item in the list above. Please check if they are still attached to the packaging or inside the cabinet. Occasionally the item may have been pre-installed at the factory. Please refer to the parts list section this manual to ensure you have all the components to set up this machine.

NOTICE: This machine comes with various standard sized, non-proprietary parts. If any of these parts are missing, we be happy to deliver them to you. To have the machine up and running as soon as possible, you can also find these parts at your local hardware store.

Additional Items Recommended for Machine Assembly

<i>Item</i>	Purpose
Safety Glasses	Protection
Disposable Gloves	Protection
Paper Towel / Rags	Cleaning
Rust Inhibitor	Cast iron table top rust protection.
Straight edge	Check alignments.
Metric Combination Wrench Set	Assembly and Maintenance
Metric Hex Wrench Set	Assembly and Maintenance
Torque Wrench	Cutter inserts installation and for checking torx screw tension (50-55 lbs.-inch).
T25 Star Bit Socket	Cutter inserts installation.

Removing Machine from Crate

When all items are ready for setting up the machine, gently remove the machine from the pallet. The planer is equipped with casters so it can be push off the pallet with the help of a ramp.

The base of the planer is bolted onto the pallet to prevent shifting during transport. Remove these screws and brackets if you see them. You may reuse the hardware if the machine is to be bolted onto the floor.



WARNING

10014 Planer has a net weight of 401 lbs. All lifting devices must be capable to handle the load, or serious personal injury and machine damage may occur.

Cleaning

To prevent rusting, the cast iron bed and extension tables of this planer are covered with machine oil and a plastic film. Remove the plastic film, then wipe off the machine oil with paper towels or rags.

Once all the machine oil is removed, routinely coat the unpainted cast iron surface with rust preventive such as Boeshield® T-9 or paste wax. Do not use rust preventives that contains silicon, which is known to interfere with certain finishes and glues.

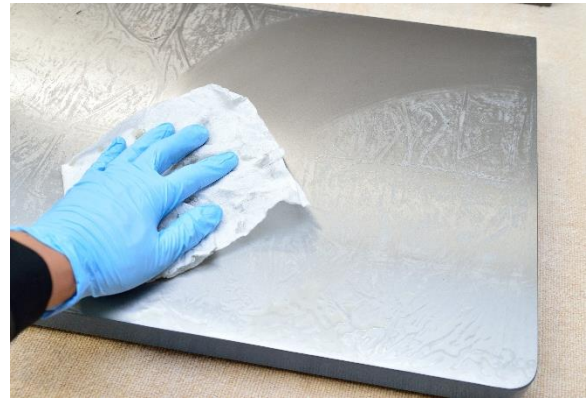

Assembly

This planer is mostly assembled in the factory. There are a few more items to set up before the machine is ready for a test run:

1. Install height adjustment handwheel.
2. Install dust hood.
3. Install extension tables.
4. Connect planer to a dust collection system.
5. Connect planer to power source.

The approximate time for cleaning and assembly is approximately 60 minutes.

Installing Height Adjustment Hand wheel - See page 63 for updated locking handle information.

1. To install the height adjustment handwheel, you will need the key, nut and the washer. They are taped onto the handwheel shaft. Carefully remove the tape to retrieve these parts.
3. Insert the key into the keyway on handwheel shaft.
4. Insert the handwheel and make sure the keyway on the handwheel is aligned with the key.

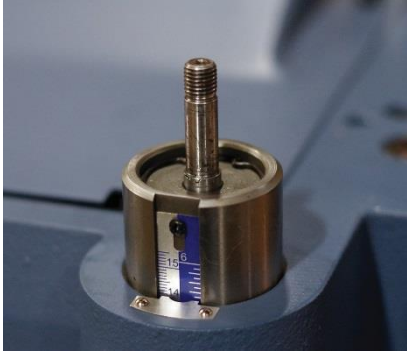

2. Install the handle of the handwheel and tighten with a 14mm wrench.



5. Install the washer and nut, then tighten the nut with a 17mm wrench.



Installing Dust Hood

Use the provided cap screws and washer (#7 in "Inventory"), to mount the dust port on top of the cutterhead cover:

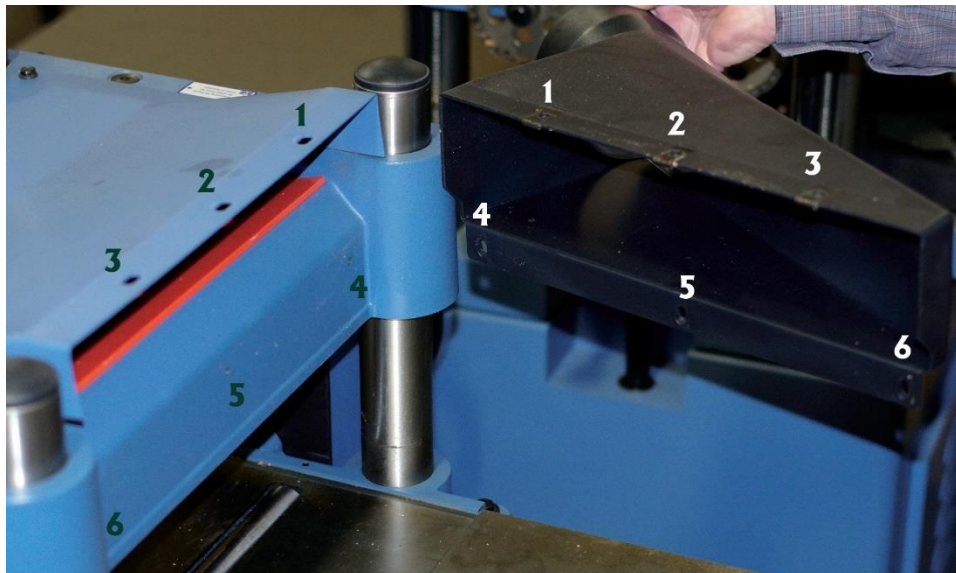

Installing Extension Tables



Each extension table weighs 21 lbs. and it can be difficult to install by one person. Get assistance to install the extension tables when needed.

1. Attach the extension table to the planer with the provided mounting bolts (#5 in "Inventory"). Do not fully tighten the bolts yet. Just make sure it is tight enough to hold the extension table in place. Then hand thread the set screws into the extension table.

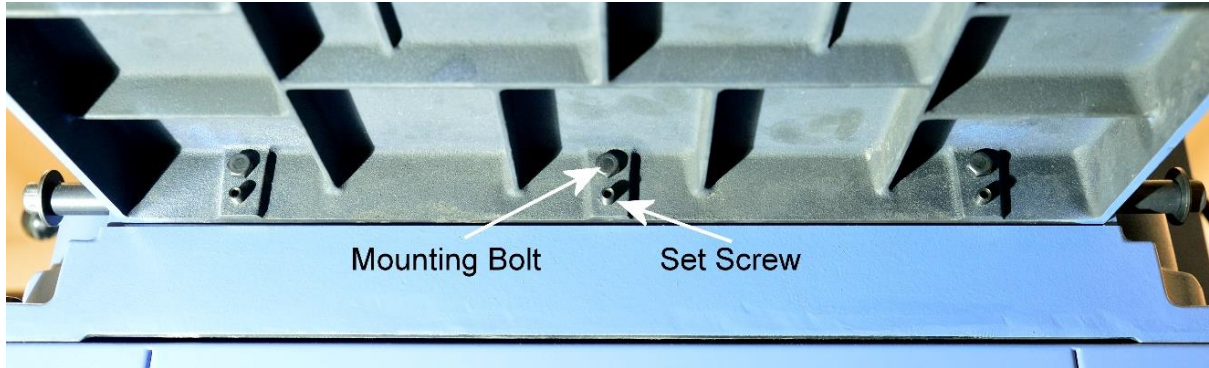

2. Align the edge of extension tables with the edge of the planer bed. Make sure the edges are flush with each other.

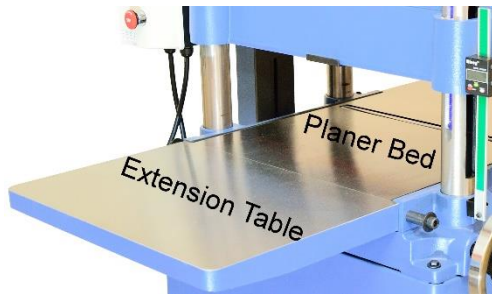

3. Use a straight edge to check if the extension tables are in parallel with the planer bed. At this point the extension table should be slightly sagged.



4. Rotate the set screws with a hex wrench to raise the extension tables. For each set screw, make small, incremental adjustments, and then move on to the next set screw. Repeat until both extension tables are in parallel with the planer bed. If a set screws become too difficult to turn, you may need to slightly loosen the mounting bolts before continue to raise the extension table.

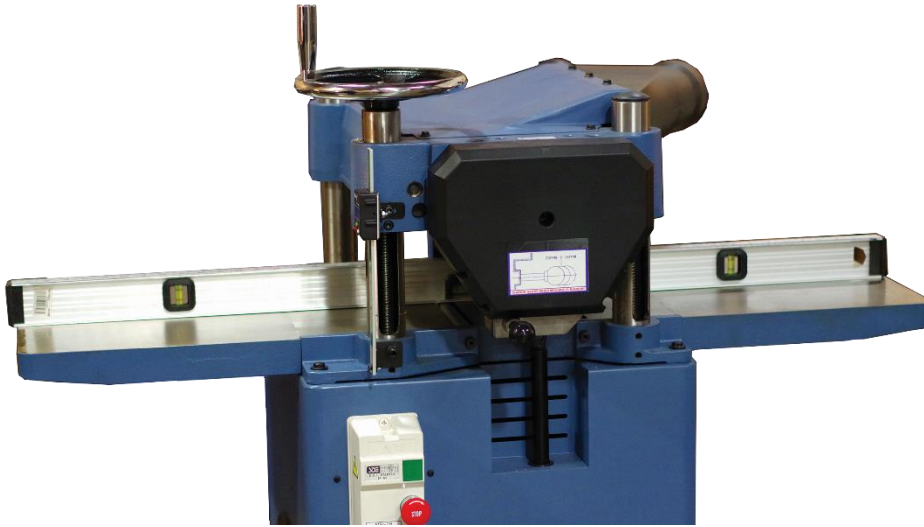

5. When the extension tables are in parallel with the planer bed, tighten all mounting bolts. Recheck table parallelism for one more time.
6. **Save these instructions as the extension tables will need to be adjusted from time to time.**

Dust Collection

Wood planer can generate a lot of wood shavings and dusts. Connect the dust collection system to this machine. Minimum CFM requirement for this planer is 600 CFM at the dust port, which means your dust collection system should have a rating greater than 600 CFM, as air friction from the ducts reduces the effective CFM at the dust ports.

IMPORTANT

Running this planer without dust collection system, or using a dust collection system with inadequate suction, will cause dust and shavings to accumulate inside the planer. This can damage the machine and cause other hazardous situations. Check your dust collection system regularly to make sure it is not jammed or filled up.

Wiring and Grounding



DANGER

Deenergize the electrical circuit before touching any enclosed, electrified parts. Touching electrified part WILL result in serious personal injury or death.



WARNING

All electrical work must be done by a qualified electrician, and must meet the electrical code in your area.

Make sure the voltage of your power circuit matches the specifications on the nameplate of the machine, and the circuit is sized to supply power to the planer.

Wiring Instructions

This machine is not pre-wired with a plug. A 7-foot long 14 AWG cord is provided for connecting this machine to a power source. If you plan to connect the machine directly to the electrical panel (“Hardwiring”). Please ensure there is a readily accessible electrical disconnect near the machine. Refer to section “Wiring Diagram” for wiring your machine to a power source.



If you choose to connect this machine with a plug and a cord, please use a UL/CSA listed plug that is sized to meet the amperage requirement of your machine.

Break-in Period

Congratulations for getting this machine assembled and ready for a test run! Please set a reminder to service this machine as it goes through the break-in period. Completing these services will maximize the performance and longevity of your machine.

After 16 hours of operation: Adjust V-belt tension.

After 50 hours of operation: Replace gearbox oil.

Controls and Components

ON / OFF Switches

To Turn Off Machine

Press the "STOP" button.

NOTICE: When STOP button is pressed, it needs to be reset before the planer can start again. To reset, rotate the serrated rim clockwise. The STOP button will pop up when it is reset.

NOTICE: The planer will shut down if it is overloaded. Press STOP to reset overload protection.

To Turn On Machine

Press the green "START" button.

NOTICE: The machine will only start when the STOP button is reset.



Cutterhead Height Adjustment

The cutterhead height adjustment handwheel is located on the side of the planer, right below the digital readout.

Turn **CLOCKWISE** to lower the cutterhead.

Turn **COUNTERCLOCKWISE** to raise the cutterhead.

Each rotation of the handwheel changes the height by approximately 1/8" (3mm).

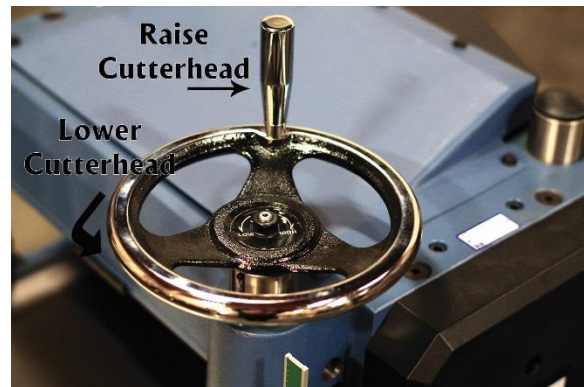

Cutterhead Height Scale

The cutterhead height scale is located on the right column next to the digital readout. A metal pointer marks the current height of the cutterhead.

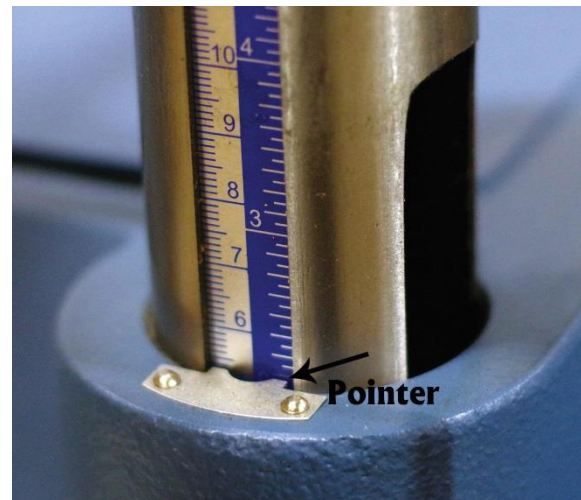

Digital Readout (DRO)

This planer is equipped with a Wixey DRO with 0.005" or 1/32" resolution. Fractional inch value will appear if the measurement is a multiple of 1/32.

MM/IN Button

Toggle measuring unit between metric (mm) and US standard (inch).

ABS/INC Button

Toggle between absolute mode and incremental mode.

The absolute mode shows the distance between the table and the cutterhead. Once calibrated, the settings will be memorized unless the battery is exhausted.

The incremental mode shows the distance the cutterhead traveled from the last reset position. The reading can be reset by toggling to absolute mode.



ON/OFF/CAL Button

This is the DRO power switch. Hold the button to calibrate the DRO.

DRO Calibration

You will need a piece of flat scrap wood and a caliper for calibration.

1. Plane down the scrap wood until the entire surface is cut.
2. Using a caliper, measure the thickness of the midsection of the workpiece. Note down the thickness.
3. Turn on the DRO and switch to ABS mode
4. Hold the **ON/OFF/CAL** button for 3-5 seconds. "ABS" will be blinking on the display when the DRO enters the calibration mode. The reading of the absolute mode is now reset to zero.
5. To set the reading of ABS mode, press "+" (MM/IN button) or "-" (ABS/INC button) to enter the measurement taken in step #2. Hold the button to quickly increment/decrement the reading.
6. Press the ON/OFF/CAL button when the value is set. This will exit the calibration mode.
7. Once the DRO is calibrated, the DRO will memorize the value until the battery is exhausted.

Feed Rate Control

10014 Planer can feed stock at 16/20 FPM (feet-per-minute). To change feed rate, shift the position of the feed rate control knob when the machine is running at full speed with no load:

- Push in: 20 FPM
- Pull out: 16 FPM
- In between: 0 FPM (Neutral)

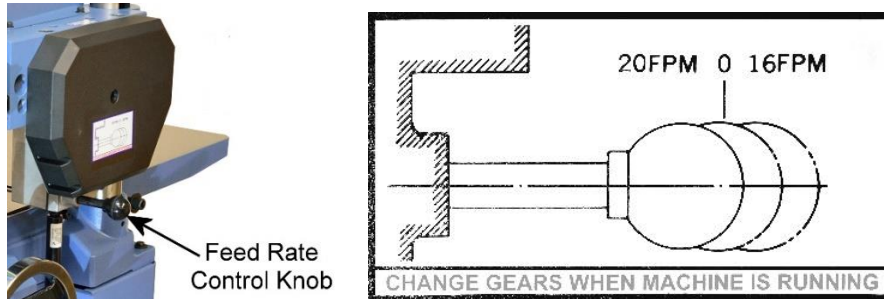

IMPORTANT

Only change feed rate when the machine is running at full speed. Failure to do so may cause the gearbox to jam and damage the machine.

Components for Planing Wood

This diagram shows components involved for planing a piece of wood:

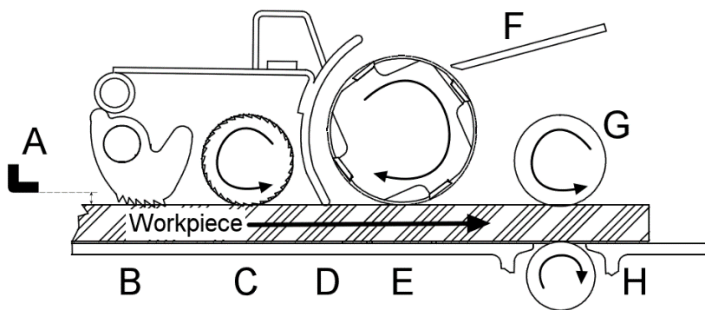

How it works:

1. When a workpiece enters the planer, with planer's depth of cut properly set, it will clear the depth limiter **[A]**. For workpiece less than 8", it is possible to bypass the limiter and receive a deeper cut.
2. The anti-kickback fingers **[B]** then engage the workpiece to prevent accidental kick-back.
3. As the workpiece moves further into the planer, it will engage the infeed roller **[C]**. The infeed roller will bring the workpiece towards the chip breaker **[D]** and the cutterhead **[E]**.
4. As the cutterhead cuts on the workpiece, the woodchips will be broken down by the chip breaker.
5. The chip breaker and the chip deflector **[F]** then divert the woodchips towards the dust port for removal.
6. As the workpiece leaves the cutter head, it will engage the outfeed roller **[G]**, which helps pulling the workpiece away from the planer.
7. The workpiece will also engage the bed roller **[H]** which helps reducing resistance as the workpiece moves along the planer table. The height of the bed roller can be adjusted to accommodate workpiece with various roughness.

Test Run

Each planer has been inspected and calibrated before leaving the factory to meet our quality and precision standards. Due to various reasons, the machine may need to be re-adjusted when it arrives at your workshop. It is recommended to complete the test run before using the planer for production work, and repeat the test run if the planer is relocated.

Step 1: Verify all electrical components are functional.

1. Remove all tools and debris from the machine.
2. Push STOP button.
3. Connect machine to the power source.
4. Turn the rim of the STOP button clockwise to reset the safety shutoff mechanism.
5. Press the green START button. The machine should be running with no excessive noise and vibration.
6. Press STOP button to turn machine off.
7. Without resetting the STOP button, attempt to restart the machine by pressing the START button. The machine should **NOT** start.
8. Reset the STOP button to restart the machine. Disconnect the machine from power source while the machine is running, then reconnect machine to power. The machine should **NOT** restart.

Step 2: Verify the planer headstock is functional and calibrated.

1. Connect planer to a dust collection system.
2. Lower the headstock all the way down. The headstock should stop at approximately 1/4" above the planer table.
3. Raise the headstock all the way up. Ensure all the anti-kickback fingers can move freely.
4. Turn on the DRO to check the readings of digital readout. The readings should reflect the movement of the headstock.
5. Prepare a piece of good quality, straight grain wood board with flat bottom for a test run. It is advised to choose a board that is close to 15" wide and at least 2 feet long.
6. Lower the headstock to remove 1/16" of the workpiece for the test run.
7. Start the dust collection system and the planer. Gently feed the workpiece towards the infeed roller. Once the infeed roller engages the workpiece, it should pull the workpiece through the planer. Verify the entire top surface has been cut.
8. Inspect the workpiece for defective finish.
9. Use a caliper to measure the thickness of each side to ensure the cutterhead is parallel with the planer table. If the thicknesses are the same, check if the reading is the same as shown on the headstock height scale.
10. Check for excessive snipes. Minimum amount of snipe may occur at the ends of the board and it is expected.
11. While the machine is running idle, move the feed rate control knob to change feed rate. This ensures the gearbox and feed rate control knob is functional.
12. **Hit STOP to turn off the planer when all tests complete.**

Congratulations for completing the test run! Now your planer is ready for production work. If you discover any issue from the tests, please refer to the troubleshooting section and maintenance section for how to diagnose the issue and make adjustments.

Operation

For safety and best results, please take the following steps for operating this machine.

Step 1: Preparation

Only Use Natural, Good Quality Wood

Only plane natural wood materials that is in good quality. Cracked stock, board with loose knots, plywood and other engineered wood products can break apart and cause severe kickbacks, which can lead to severe injuries and machine damages.

Do not plane treated lumber or anything that contains harmful chemicals, as this will spread wood dusts that contain such harmful chemicals. NEVER plane boards that are shorter than 7" as mentioned in the specifications.

Inspect the Workpiece

Carefully inspect the workpiece for foreign objects. Nails, staples, rock chips and other objects embedded on the wood surface will damage the planer. To avoid chipping/dulling the cutter inserts, it is advised to clean a workpiece with a stiff brush to remove all dirt and foreign objects before planing, especially for rough sawn or reclaimed lumber. Use metal detector to scan for metal as needed.

Check Moisture Content

Check moisture content of the workpiece before operation. "Green wood" with moisture content over 20% will not cut properly and may jam the machine. Excessive moisture content will also cause planer's unpainted surface to rust. Besides, as the workpieces dries, the planed surface will become fuzzy, and the workpiece may warp. It is recommended to allow the workpiece to dry and stabilize before it is processed.

Wrapped Stock

Workpiece should have a flat bottom to be processed by a planer. It is acceptable to process a slightly cupped board with the cupped side facing down and begin with light cuts. Boards with moderate cupping, bowing or twisting should have one side face-jointed before being processed by a planer.

Avoid using boards with severe wrapping, as they can be unstable and might cause severe kickbacks during operation.

Glue-Ups

Glue left on the workpiece surface can dull the cutters and reduce cut quality. Scrape off all glue from the workpiece before operation.

Wood Grain Direction

This planer is designed to plane WITH the grain direction of the wood. Do not plane cross-grain or end-grain. Severe kickback and chipping may occur.

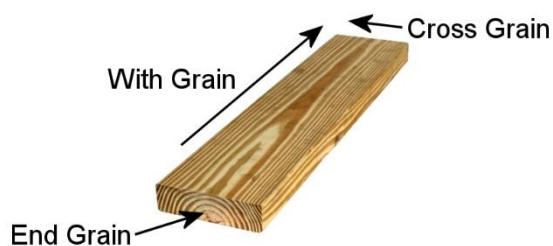

Step 2: Setting Depth of Cut and Feed Rate

This planer is capable of removing at most 1/8" per pass. For stock that is less than 6" wide, the planer can cut as much as 1/4" per pass. For best results, it is recommended to take light passes with low feed rate when approaching the desired thickness.

Wood Hardness

Depends on the hardness and brittleness of the wood type, operator should adjust the maximum depth of cut and feed rate accordingly. For workpiece that is hard/brittle, reduce the depth of cut and feed rate.

For your reference, this Janka scale shows the hardness of wood types that are commonly used. It ranks the hardness of various wood types by measuring the amount of force (in lbs.) required to embed a 0.444" steel ball halfway into the wood.

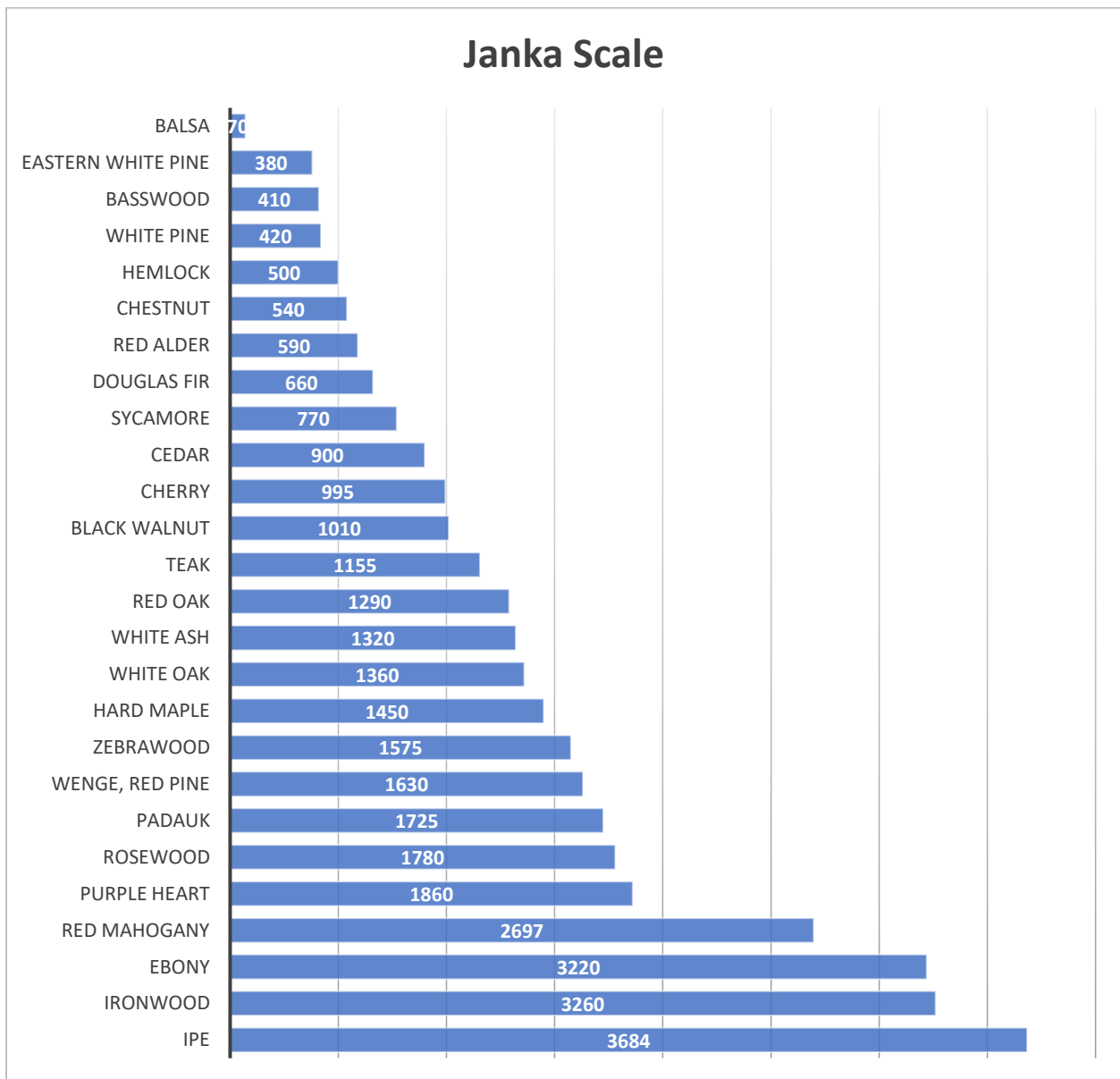

Step 3: Select Feed Direction

Inspect the workpiece and identify the direction of the edge grain. Choose a feed direction such that workpiece will receive a downhill cut.

Good – Planer Cuts Downhill

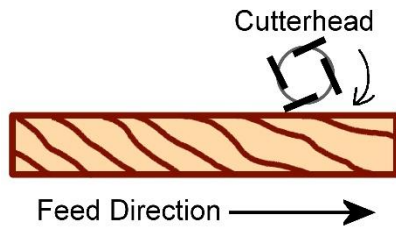

Not Ideal – Planer Cuts Uphill

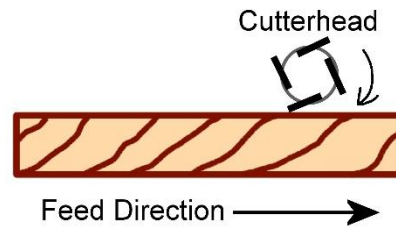

Sometimes it is impossible to perform a downhill cut for the entire length of a workpiece. In this case, try feeding the workpiece in opposite direction and see what works best. Reducing the depth of cut and feed rate can also help improving cut quality.

Step 4: Planing Wood to Desired Thickness



WARNING

ALWAYS wear goggles, and other protection device when operating this machine. Stay on the side of the planer next to the power switch to avoid kickback related accidents. NEVER look inside the planer during operation. Failing to comply may result in serious injuries or death.



CAUTION

Use ear protection device to prevent hearing loss. Ensure dust collection system is functional and use dusk mask to avoid inhaling harmful airborne particles.

With the above preparation steps completed, the workpiece is ready for planing.

1. Please put on all protection devices before proceed. If you have a long workpiece, please make sure it is properly supported throughout the process.
2. Measure the thickness/height of the workpiece, then move the cutterhead no more than 1/16" below the highest/thickest point of the workpiece. This allows the feed rollers to properly engage the workpiece, and at the same time not taking too much materials off for a test pass.
3. Turn on dust collection system and the planer.
4. While standing on the side of the planer, place the workpiece on the table with the flat side down. Gently feed the workpiece towards the infeed roller. Once the infeed roller engages the workpiece, allow the machine to feed the workpiece. **DO NOT** force feed the workpiece through the planer.

If the infeed roller does not engage the workpiece:

Headstock height is set too high. Stop the machine. Wait for the machine to come to a complete stop. Raise the headstock and remove the workpiece. Reduce the initial headstock height, and restart form step 3.

If the machine stalls or the workpiece gets stuck:

Headstock height is set too low. Stop the machine and wait for the machine to come to a complete stop. Raise the headstock and remove the workpiece. Decrease the depth of cut, and restart from step 3.

5. If the workpiece is feeding properly, wait until the entire workpiece clears the outfeed roller, then remove the work piece.
6. After the initial pass, measure the thickness at the midsection of the workpiece.

If more material needs to be removed, continue with the following steps.

7. If you need to remove a lot of material, run a few passes with deeper cuts, then finish with a light pass with shallow cuts and slow feed rate.
8. Turn on the digital readout (DRO), and use the INC mode to measure the depth of cut for each pass. If your DRO is already running in INC mode, you can reset the readings by switching to ABS mode and then come back to INC mode.
9. Using the DRO as depth gauge, lower the cutterhead. Each pass should remove no more than 1/8" for workpiece wider than 6", and no more than 3/16" for workpieces 6" or less. Reduce maximum depth of cut for harder wood types.
10. Upon completion of each pass, reset the reading of DRO. Use a caliper to measure workpiece's mid-section thickness, and decide the depth of cut for the next pass.
11. Repeat the process until the desired thickness is achieved.

Turn machine off when operation completes.

Common Cutting Problems

Snipe

When a workpiece is not properly supported as it enters or leaves the machine, the ends of the workpiece will have more materials removed than the rest of the section. To mitigate this problem, hold the workpiece up slightly as it enters and leaves the machine. Sometimes, a small amount of snipe is inevitable, and the best way to fully eliminate sniping is to prepare a workpiece with extra length, and then trim the ends when planing is done.



Chipping

Happens when making a cut against the grain direction. See “Uphill” cut in Step 3 of this section. For highly figured lumber and areas near the knot, some amount of chipping is normal. In this case, moistening the problematic area before planing can sometimes mitigate the issue.

Chipping can also be caused by dirty or dull cutters. If chipping happens while planing straight grain stocks, inspect the cutter inserts and remove all resin buildups. Rotate/replace dull cutter inserts when they are dull.



Indentation

This can happen when a foreign object is pressed on the workpiece when it passes through the planer. Remove all the resin buildups from the rollers, cutterhead and the table. Also check the dust collection system and ensure all the wood chips generated are effectively removed. Adjust the chip breaker and chip deflector as needed.

Fuzzy Grain

Can happen when planing wood with high moisture content or if the cutter is dull. Sometimes fuzzy grain is unavoidable due to the nature of certain wood types. To mitigate this issue, avoid using wood with high moisture content and use sharp cutters.

Accessories

Oliver Machinery has a collection of accessories and add-ons to enhance productivity of your planer. To purchase these items, please call us at **1-800-559-5065**, our representatives are available Monday through Friday, 9AM - 5PM Pacific time.

You may also purchase them online: WWW.OLIVERMACHINERY.NET/ACCESSORIES or
E-mail our parts department: PARTS@OLIVERMACHINERY.NET



WARNING

Using unapproved accessories may cause machine to malfunction, resulting in serious injury and/or machine damage. Only use accessories recommended for this machine.

Cutter Inserts



Genuine four-sided indexable carbide cutter insert that will fit the cutterhead of Oliver 10014 Planer. Made in Germany.

Parts number: **P-15mm 4S**

Touchup Paint



Keeping all painted surface in good condition not only keeps your machine looks nice, it keeps rusts away. We have pre-mixed spray paint available in Oliver-Blue for purchase.

Please visit our website at WWW.OLIVERMACHINERY.NET/ACCESSORIES for other recommended accessories.

Maintenance

Routine maintenance keeps your planer in top shape. Please follow the maintenance schedule below, and use the maintenance record worksheet attached in the back of the manual to document all tasks completed. **NOTICE:** Maintenance schedule may vary for individual users due to different situations and safety requirements.

 WARNING	Disconnect machine from the power source before any maintenance work is performed. After servicing the planer, remove all wrenches and tools before restarting the machine. Failure to comply can cause serious injury!
---	--

Maintenance Schedule

Interval	Component
Every day	Remove dust buildups from planer and dust collection system.
	Inspect power cord for sign of aging and damages. Replace as needed.
Every week	Inspect and clean cutterhead, rollers and anti-kickback fingers. Remove any dust and resin accumulation.
	Inspect/rotate/replace worn cutter inserts.
	Apply rust protectant on unpainted cast iron surfaces.
	Verify extension tables are level with the planer bed. Adjust as needed.
Every month	Check V-belt tension and replace if belt shows signs of cracking or glazing.
Every 4-6 months	Remove dust buildups from motor and the cabinet.
	Inspect table chain for chain slacks.
	Check parallelism between the table and cutterhead, and the rollers.

Notice: Motor bearings are permanently sealed and lubricated, and do not require lubrication.

Lubrication Schedule

Component	Interval	Types of Lubricant	Reference
B - Feed roller shafts	Every 30 hours	SAE-30 oil.	Figure 1
C - Drive chains and sprockets	Monthly	General purpose grease	Figure 2
D - Lead screws (x4)		General purpose grease	
E - Columns (x4)		Clean and lubricate weekly	
F - Gear box	Replace gear box oil after first 50 hours, then every year.	Standard gear oil, 70-90 weight. Remove gearbox cover to access drain plug and fill plug. Drain and recycle used oil. Refill oil until it reaches the fill plug.	Figure 3
G - Outfeed roller	Clean and lubricate as needed.	Very light coat of SAE-30 oil.	Figure 4
H - Infeed roller			Figure 5
I - Anti-kickback fingers			
J - Bed roller			
K - Table chain and sprockets	Every 4 to 6 months	Grease, or good quality cycle chain lubricant. Remove motor access panel to access components.	Figure 6

Figure 1

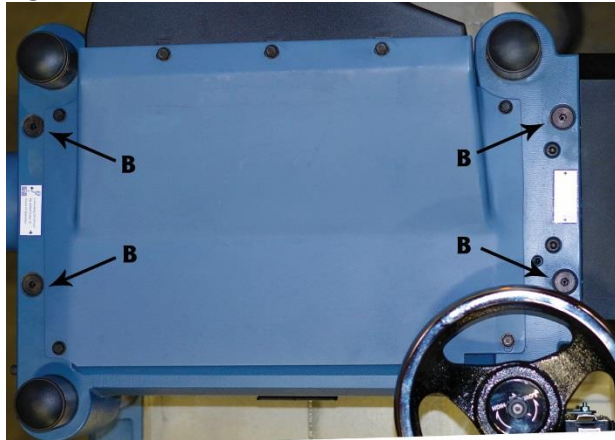

Figure 2

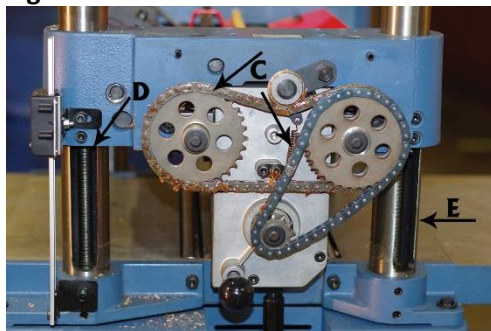

Figure 3

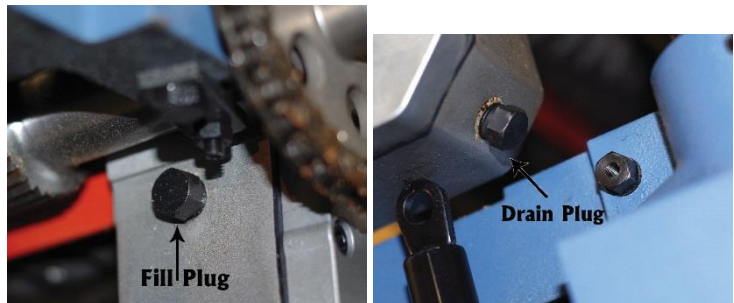

Figure 4

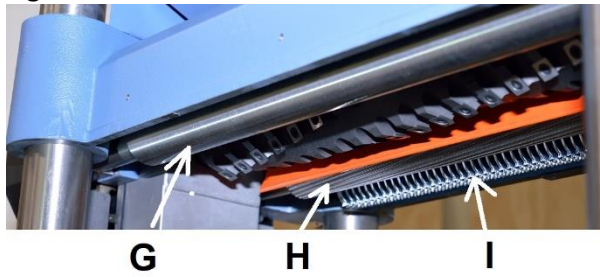

Figure 5

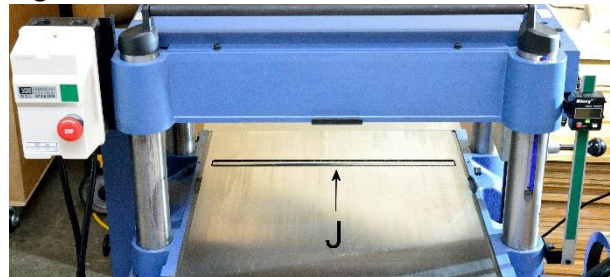
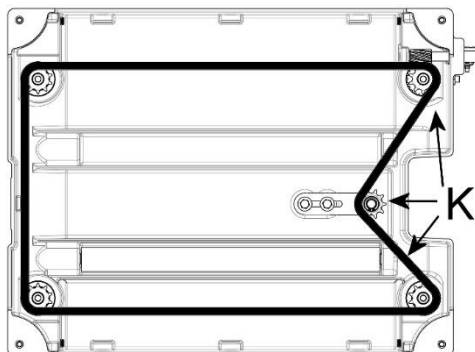



Figure 6



 WARNING	Disconnect machine from the power source before any maintenance work is performed. After servicing the planer, remove all wrenches and tools before restarting the machine. Failure to comply can cause serious injury!
---	--

Remove Planer Top Cover

This allows you to service the cutterhead, chip deflector, and chip breaker.

1. **Disconnect planer from power source!!**
2. Remove dust port.

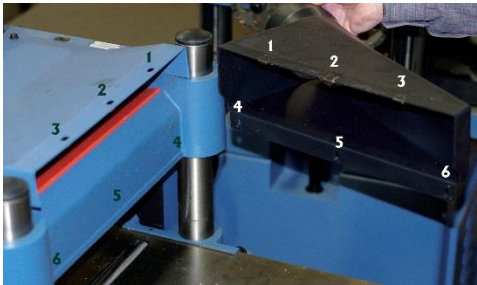

3. Remove the planer cover by removing the four cap screws from the top of the planer.



Adjust Chip Deflector Clearance

The chip deflector was pre-installed in the factory and should not require adjustments initially. If the gap between chip deflector and cutterhead goes beyond the 1/16" - 1/8" tolerance, adjustment is needed.

1. **Disconnect planer from power source!!**
2. Remove dust port and top cover.
3. Loosen the three bolts that secure the chip deflector.

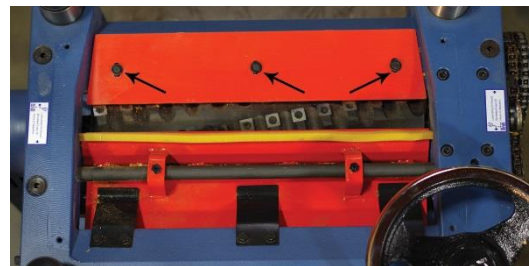

4. Adjust the distance between the chip deflector and the cutterhead. The entire edge of the chip deflector should be no less than 1/16" away from the closest point of the cutter head, but no more than 1/8".

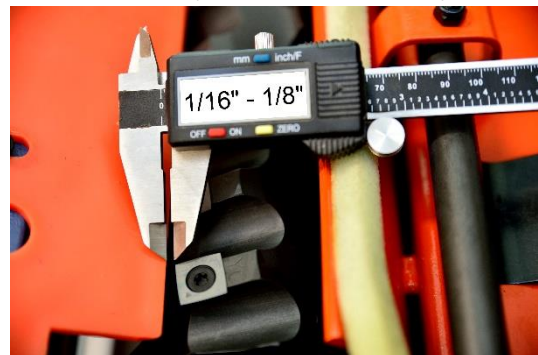

5. Re-tighten the bolts to secure the chip deflector, then reinstall the top cover and dust port.
6. Remove all wrenches and tools before restarting the planer.

Service Cutterhead and Rotate Cutter Inserts



CAUTION

Cutter inserts on the cutterhead are extremely sharp. Protect your hands with thick leather gloves to avoid injuries.

1. **Disconnect planer from power source!!**
2. Remove dust port and top cover.
3. Remove dusts and resin accumulations on the cutterhead and the area nearby.
4. Rotate the cutter inserts 90° clockwise when they get dulled or nicked. Use a permanent marker to mark the new edge to be used.
5. To rotate/replace a cutter insert, remove the torx screw with a T-25 torx bit. Turn **COUNTERCLOCKWISE** to loosen the screw.

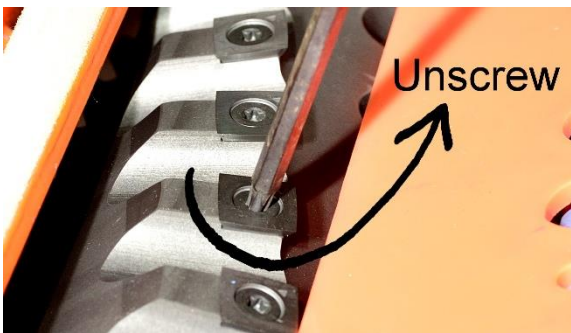

8. Inspect the torx screw. Replace any damaged screws. Lubricate the screw thread with a thin coat of light weight machine oil.

IMPORTANT: Do not use excessive amount of lubrication, or the torx screw and the cutter insert will not sit properly.

9. Using a torque wrench, re-tighten the torx screw with 50-55 lbs.-inch of torque.

IMPORTANT: Do not overtighten the screw or the inserts may break. Do not use power tools to tighten the torx screws as it can strip the screws.

10. Reinstall top cover and dust port when cutterhead service completes.

11. Remove all wrenches and tools before restarting the planer.

6. With the cutter insert removed from its platform, thoroughly clean the cutter insert platform with a vacuum or compressed air.



IMPORTANT: Obstacles between the insert and cutterhead platform will create uneven pressure against the insert. This will lower cut quality and may cause the insert to crack.

7. Reinstall the cutter insert with the marked cutting edge facing out.

Adjust Belt Tension

⚠ CAUTION: Belt and pulleys may be hot after operations. Allow components to cool before servicing.

IMPORTANT: After initial break-in period. The V-belt should stretch by some amount. Check and adjust belt tension after 16 hours of operation.

1. **Disconnect planer from power source!!**
2. Remove the knobs that hold the belt cover in place.

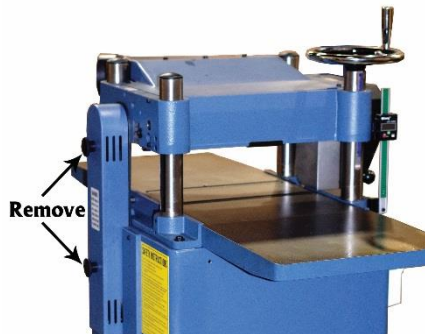

3. Apply moderate pressure on the V-belt midway between the two pulleys. Properly tensioned V-belt should deflect by approximately 1/4".

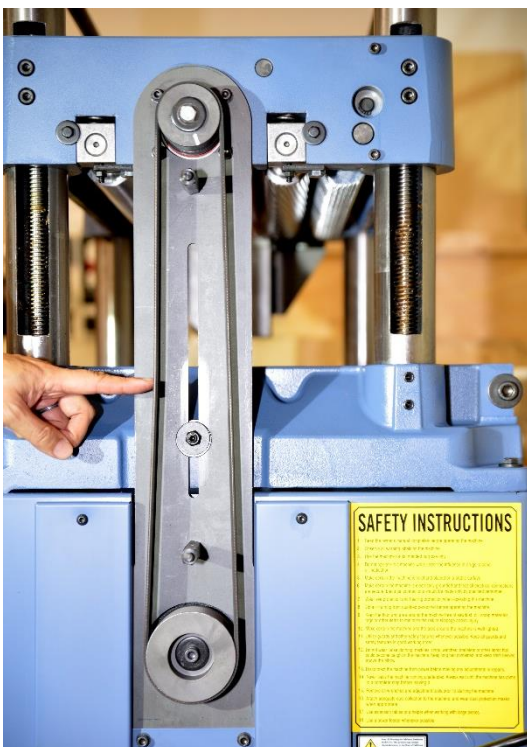

If belt tension needs adjustment:

4. Remove the side panels to gain access to the motor mount cap screws.



5. Loosen the cap screws and lower the motor to tighten the belt. If the belt becomes too tight, raise the motor.

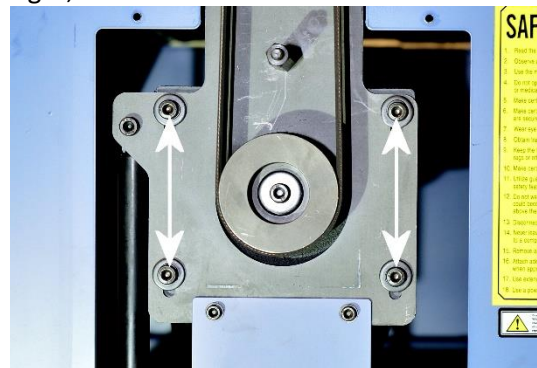

6. Re-tighten the motor mount cap screws and re-install the side panels when belt is properly tensioned.

If belt needs to be replaced

7. Loosen the belt and roll the belt off the pulleys.
8. Install new belts and make sure the belt sits into the grooves of the pulleys.
9. Adjust belt tension.
10. Set a reminder to readjust belt tension after the new belt is broken in. The process takes approximately 16 hours of run time.

When belt maintenance completes

11. Reinstall all the panels and covers.
12. Remove all wrenches and tools before restarting the planer.

Adjust Table Chain Tension

1. **Disconnect planer from power source!!**
2. Remove motor access panel.



3. Loosen the two locking bolts for holding the chain tensioner bracket in place.

IMPORTANT: Keep table chain tensioned while loosening the locking bolt. If the chain falls off from the sprockets, it can take a lot of time to reinstall the chain and recalibrate the planer.

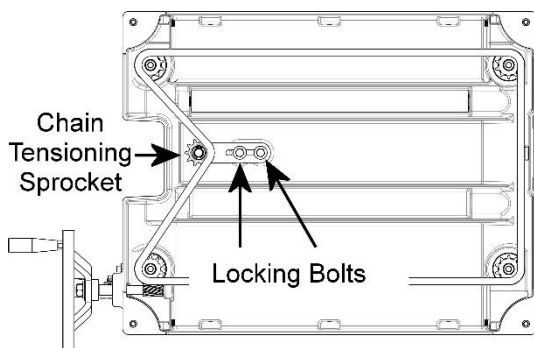

4. Push the chain tensioning sprocket against the chain with moderate tension to remove chain slack. Hold the sprocket in place, and re-tighten the locking bolts.
5. Clean and lubricate the chain as needed.
6. Re-install motor access panel when adjustments complete.

Adjust Table Roller Height

Your planer is equipped with one table roller to help feeding a workpiece through the planer. There is no fixed rule for setting the exact height of the table rollers, because each piece of wood behaves differently. The acceptable range of table roller height is: **0.002" - 0.005"** above the table.

As a general rule of thumb:

- Raise the roller when planing rough stock.
- Lower the roller when planing smooth stock.

NOTICE: If the roller is set too high, the workpiece will be more likely to have snipe on the ends.

To adjust table roller height:

1. **Disconnect planer from power source!!**

2. Each end of the table roller is equipped with a set screw and an eccentric adjuster. Make sure height adjustment is done on both ends.

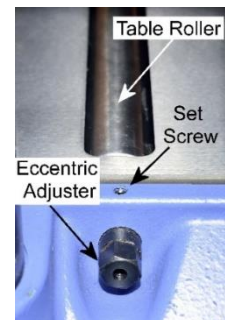

3. Loosen the set screws that hold the eccentric adjusters.
4. Rotate the eccentric adjusters to change roller's height.
5. Use a dial indicator to verify the height is the same side-to-side. Make fine adjustments as needed.



6. Retighten the set screws to lock the eccentric adjusters when adjustments complete.

Adjust Cutterhead/Feed Roller Height Offset

The infeed/outfeed rollers pull the workpiece through the planer. To ensure optimal feeding/cutting performance, it is important to ensure the height offsets between the cutterhead and the feed rollers are correct.

The following diagram shows the height offset between the cutterhead and various components inside the headstock of the planer. The feed rollers and chip breaker are installed **BELOW** the lowest point of cutterhead.

Chip Breaker

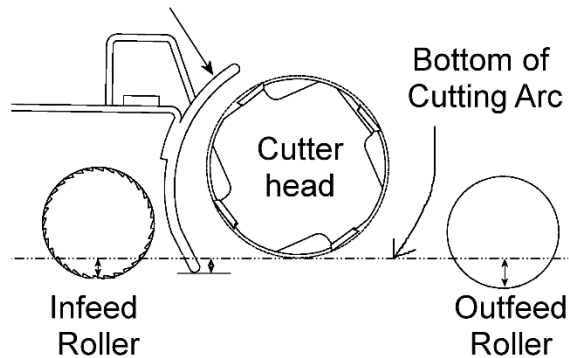

**Diagram not drawn to scale*

The height of the rollers and the chip breaker has been pre-calibrated in the factory and should not need further adjustments.

In case if adjustments are needed, you will need a dial indicator with a sturdy stand. If a dial indicator is not available, it is possible to make the adjustments with a home-made gauge block and a set of feeler gauges.

Clean the table and the rollers to remove any accumulations before making adjustments.



Method 1: Using a Dial Indicator

1. Remove all tools from the planer.
2. Turn on the planer, wait until it reaches full speed, then shift the feed rate control knob to 0 FPM (Neutral) position.

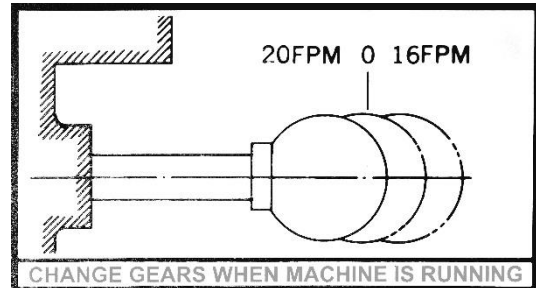

3. Turn off planer. Disconnect planer from power source!!
4. Remove the belt cover so you can rotate the cutterhead with the drive belt.
5. Raise the headstock, fit the dial indicator right below the cutterhead. Rotate the cutterhead and use the dial indicator to locate its lowest point. Using a flat bottom tip for the dial indicator can make this task easier.

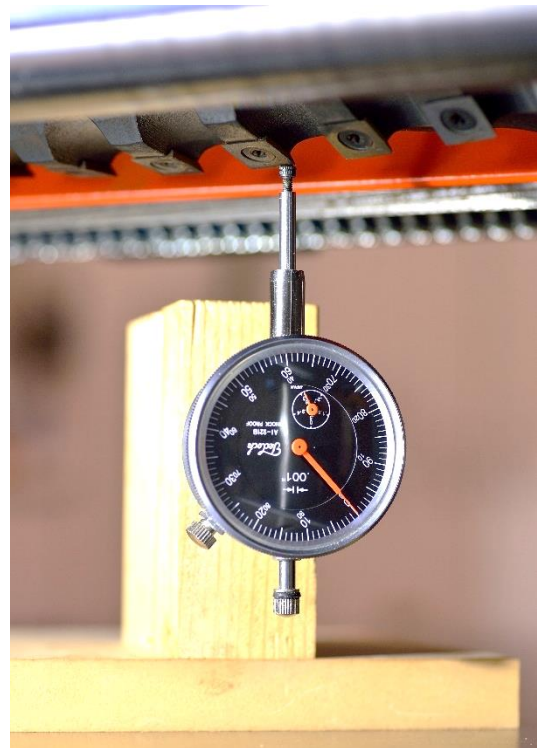

6. Zero the dial indicator. Use this as the reference point for measuring the offset

between the cutterhead and the feed rollers.

7. Move the dial indicator to the lowest point of the feed rollers. The reading from the dial indicator now shows the offset between the cutterhead and the roller. Made adjustments if the offset goes beyond the tolerance listed below.



	Tolerance
<i>Infeed Roller</i>	0.020" - 0.027" below
<i>Chip breaker</i>	0.000" - 0.020" below
<i>Outfeed Roller</i>	0.024" - 0.031" below

8. To adjust the height of the feed rollers, loosen the jam nuts on both ends of the feed roller. Rotate the set screws to change the height of the roller. Continue to calibrate until the cutterhead-roller offset is uniform across the entire feed roller.

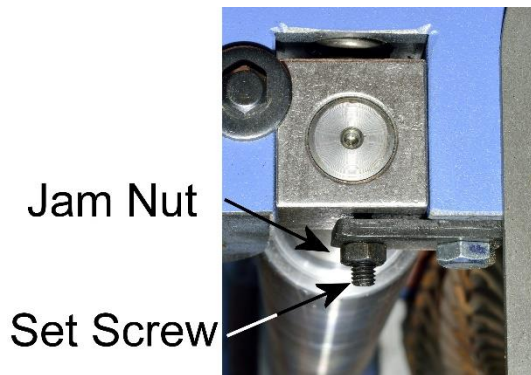

9. When the correct height is set, hold the set screws in place and re-tighten the jam nuts.
10. Re-install belt cover when adjustments complete.

Method 2: Using Feeler Gauge

1. Using hardwood, build a gauge block similar to this one below. The exact dimension is not critical. Just make sure the bottom clears the table roller. The top should be chamfered for better tool access and visibility.

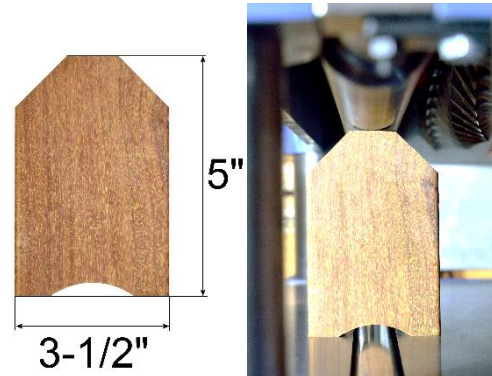

2. Remove all tools from the planer.
3. Turn on the planer, wait until it reaches full speed, then shift the feed rate control knob to 0 FPM (Neutral) position.

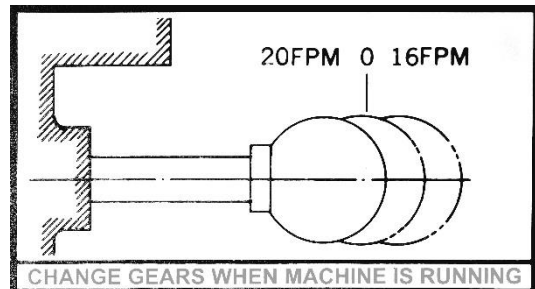

4. Turn off planer. Disconnect planer from power source!!
5. Remove the belt cover so you can rotate the cutterhead with the drivebelt.

6. Raise the headstock, place the gauge block below the cutterhead. For checking the infeed roller's offset, put the **0.020"** feeler gauge on top of the gauge block.
7. Lower the cutterhead until the lowest point of the cutterhead barely touches the feeler gauge.



8. Remove the feeler gauge and move the gauge block under the infeed roller. The gauge block should fit right under the infeed roller if the height setting is perfect. You may need to rotate the infeed roller to find the lowest spot. Made adjustments according to specifications as needed:



	Tolerance
<i>Infeed Roller</i>	0.020" - 0.027" below
<i>Chip breaker</i>	0.000" - 0.020" below
<i>Outfeed Roller</i>	0.024" - 0.031" below

9. To adjust the height of the feed rollers, loosen the jam nuts on both ends of the

feed roller. Rotate the set screws to change the height of the roller. Continue to calibrate until the cutterhead-roller offset is uniform across the entire feed roller.

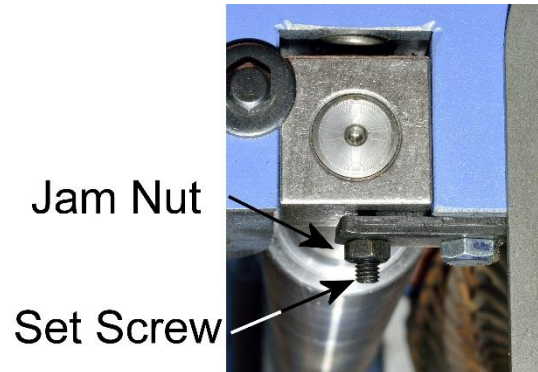

10. When the correct height is set, hold the set screws in place and re-tighten the jam nuts.
11. Repeat **STEP 7-13** for the outfeed roller, and use a 0.030" feeler gauge instead.
12. Re-install belt cover when adjustments complete.

Adjust Feed Roller Tension

If your workpiece is slipping and not feeding through the machine, increase the feed roller pressure by turning the pressure bolts clockwise with a hex wrench.

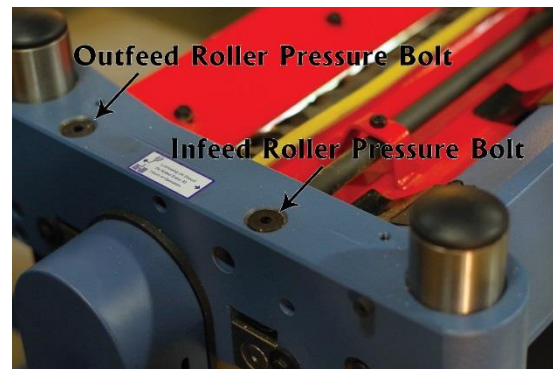

There is a pressure adjustment bolt on each end of the feed rollers. Make sure the adjustments are made on **BOTH** ends of the feed roller, so even pressure is applied across the entire feed roller.

If the workpiece is damaged by the feed roller, reduce pressure.

Adjust Cutterhead Height Scale

The cutterhead height scale is pre-calibrated at the factory. It can be adjusted to accommodate a different viewing angle, or if the scale is shifted.

1. Prepare a piece of 2x4 with flat bottom for calibration.
2. Using the digital readout, plane the board down to 1-1/4" or 1". Use a caliper to measure the mid-section of the board for thickness.
3. Loosen the top and bottom screws that holds the scale in place.

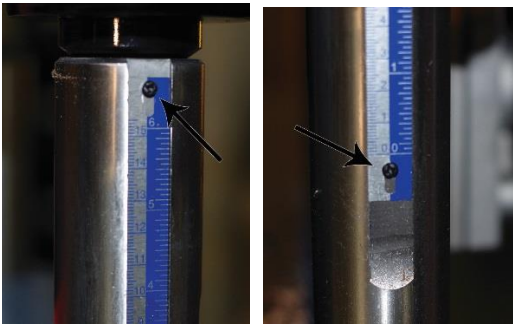

4. Shift the scale so that the pointer is pointing at the exact value as the thickness of the board.
5. Re-tighten the screws when adjustments complete.

Anti-Kickback Fingers Inspection

This planer is equipped with anti-kickback fingers. Once engaged, the workpiece can only move towards the cutterhead. This prevents accidental kickbacks which can cause serious injuries.

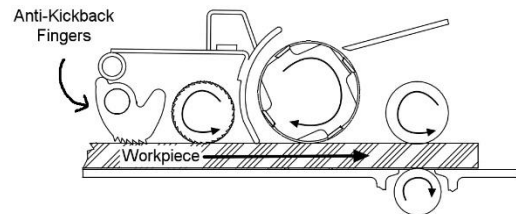

Inspect the anti-kickback fingers regularly to ensure they can move freely, and that their teeth are clean and are sharp enough to stop a board from moving backwards. Clean and lubricate with very light coat of SAE-30 machine oil as needed.

Replace anti-kickback fingers if they are damaged or worn.

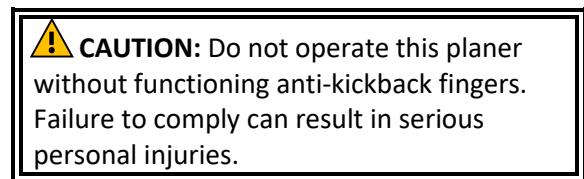

Troubleshooting

Problem	Possible Cause	Possible Solution
Machine does not start.	Stop button is not reset.	Turn the rim of the STOP button clockwise to reset. The stop button will pop up.
	Machine is not connected to a power source.	<ol style="list-style-type: none"> 1. Make sure machine is plugged in, or power disconnect is at the ON position. 2. Check electrical panel for tripped circuit breaker or blown fuse. 3. Ensure all electrical connections have good contacts.
	Low voltage / current.	Have an electrician to check/repair the power circuit.
	Faulty switch/motor/capacitor.	Contact customer service for further assistance.
Machine trips thermal protection / circuit breaker, or blow fuses.	Machine is undersized for the operation.	Reduce the depth of cut and/or feed rate.
	Workpiece moisture level is too high.	Only plane wood with moisture level below 20%.
	Machine is jammed.	Inspect cutterhead and make sure it is not obstructed by woodchips. Check dust port and headstock and clear blockages.
	Too much load on a circuit.	Make sure the power circuit is sized for this machine. If the same circuit is shared, ensure the circuit is sized to supply power for all items in the circuit.
	Motor/capacitor issue.	Contact customer service for further assistance.
Machine stalls during operation.	Machine is undersized for the operation.	Reduce the depth of cut. Lower feed rate.
	Dull cutters	Rotate/replace cutter inserts.
	Belt slipping	Clean belt and the pulleys. Adjust belt tension.
	Motor/capacitor issue.	Contact customer service for further assistance.
Machine stopped during operation.	Thermal overload protection triggered.	Hit STOP button to reset overload protection. Wait for the machine to cool down. Reduce depth of cut and feed rate before continue.
Chain jumps during operation.	Loose chain.	Replace chain.
	Misaligned sprockets.	Align sprockets.
	Worn sprockets.	Replace sprockets and chains.
Digital readout not functional.	Dead battery.	Replace battery.

Problem	Possible Cause	Possible Solution
Unable to move feed rate knob.	Machine is not running.	Only move feed rate knob while the machine is running idle at full speed.
Feed rollers does not move when machine is running.	Gear box is in neutral.	Shift feed rate control knob to set feed rate to 16/20 FPM while machine is running idle at full speed.
Workpiece does not feed smoothly.	Low feed roller pressure.	Adjust feed roller spring tension.
	Incorrect feed roller height setting.	Adjust feed rollers height so the bottom of the rollers is below the lowest point of the cutterhead. Infeed Roller: 0.020" - 0.027" below. Outfeed Roller: 0.024" - 0.031" below.
	Dirty planer table / rollers.	Clean table and rollers. Apply paste wax on the table to reduce drag. Do not use silicon lubrications on table top.
	Belt slipping	Clean belt and the pulleys. Adjust belt tension.
	Stuck planer bed roller.	Clean and lubricate roller.
Machine vibrates excessively or makes unexpected noise.	Damaged cutter inserts.	Replace cutter inserts.
	Machine stands on uneven floor.	Reposition on flat, level surface.
	Chip deflector is hitting the cutterhead.	Move chip deflector 1/16"- 1/8" away from cutterhead.
	V-belt worn, slipping or hitting belt cover.	Clean belt and pulleys. Adjust belt tension. Replace V-belt if it shows signs of aging.
	Feed roller bushing needs lubrication.	Lubricate bushings.
	Bent pulley	Replace pulley.
	Improper motor mounting.	Check and adjust motor mounting.
	Loose components.	Tighten fasteners of the component.
Worn bearings	Contact customer service for assistance.	
Uneven depth of cut side to side.	Cutterhead is not parallel with planer table.	Adjust cutterhead-table parallelism. Tolerance: Less than 0.005" side-to-side.
Board thickness does not match the scale's measurement.	Cutterhead height scale is mispositioned.	Adjust the scale.

Problem	Possible Cause	Possible Solution
Workpiece came out twisted.	Workpiece is twisted before the cut.	Planer is not the tool to flatten a twisted workpiece. Flatten one side with a jointer before proceeding with a planer.
	Feed/bed roller is not parallel with the cutterhead.	Adjust roller/table parallelism.
Excessive snipe	Extension tables slope down.	Adjust the extension tables to make them parallel with the planer bed.
	Long workpiece is not supported properly.	Use auxiliary rollers to support long workpiece.
	A small amount of sniping can happen sometimes.	Add an extra 6" length on a workpiece for planing, and then trim off the ends.
End of workpiece chipping	Aggressive depth of cut for the wood type.	Reduce depth of cut.
	Planing end grain.	Do not plane end grain. Use a drum sander instead.
Chipping in workpiece surface.	Damaged cutter.	Rotate/replace cutter insert.
	Planing against/across grain; or knots.	Avoid planing workpiece with knots. Plane along the grain and perform downhill cut whenever possible. Moisten problematic areas before planing.
	To much material removed in one pass.	Reduce feed rate / depth of cut.
Indentation in workpiece surface.	Dirty rollers.	Remove all buildups on infeed, outfeed, and table rollers.
	Inefficient chip removal.	Check dust collection system for suction. Adjust chip breaker and chip deflector.
Fuzzy looking finish.	Wood moisture content too high.	Only process wood with less than 20% moisture content.
	Dull cutter.	Rotate/replace cutter insert.
	Some wood types tend to have fuzzy grain.	Adjust feed rate / depth of cut. Use sharp cutters.
Glossy looking finish.	Dull cutter.	Rotate/replace cutter insert.
	Cutting depth too shallow.	Increase depth of cut.
Long line or ridges running along the length of board.	Chipped cutter.	Rotate/replace cutter insert.
Serrated marks on workpiece.	Cutting depth too shallow.	Increase depth of cut.

Wiring Diagram

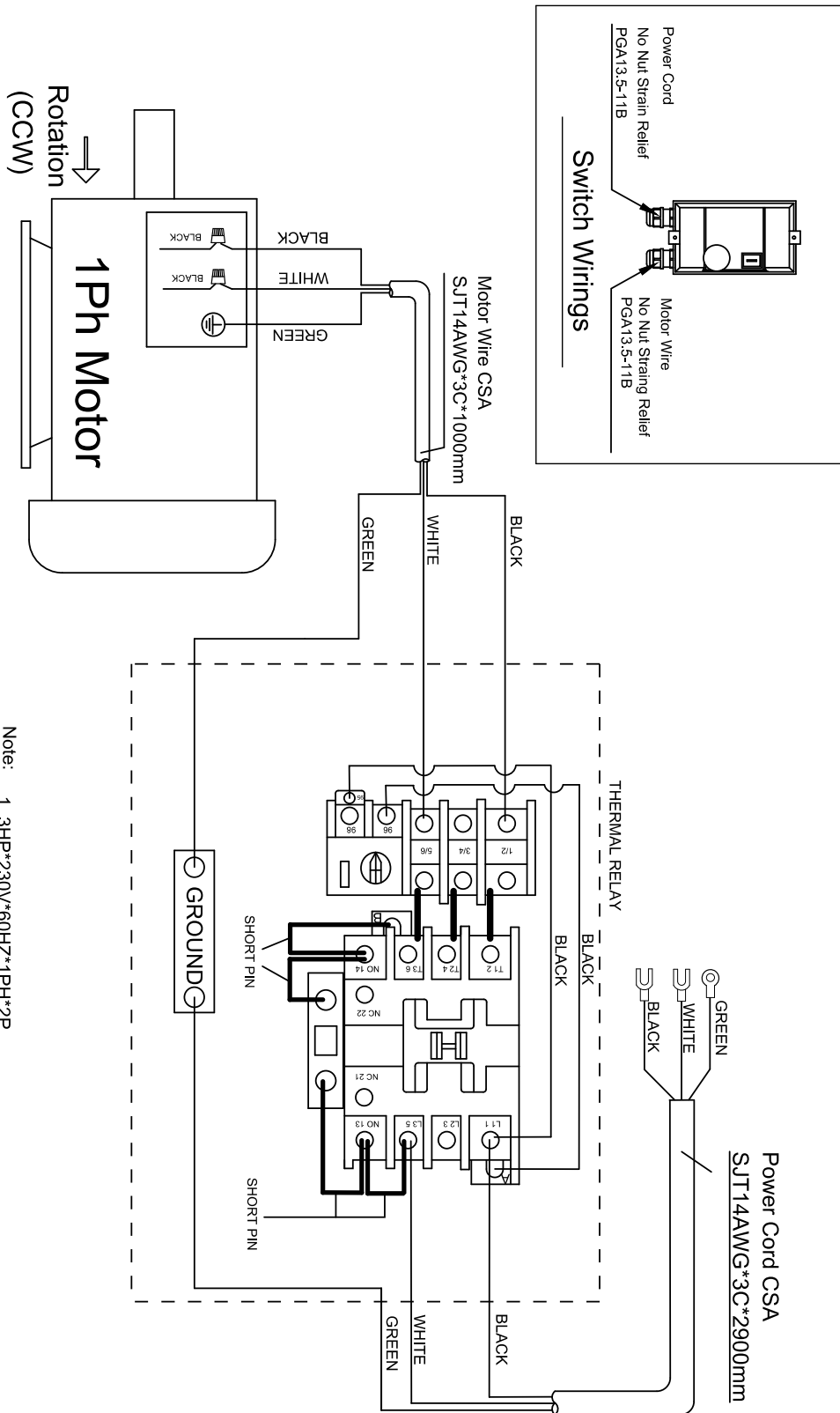

- Note:
1. 3HP*230V*60HZ*1PH*2P
 2. Toothed Washer included for GROUND
 3. Rated Amp for overload setting
 4. Sheridian Switch

Cabinet Assembly

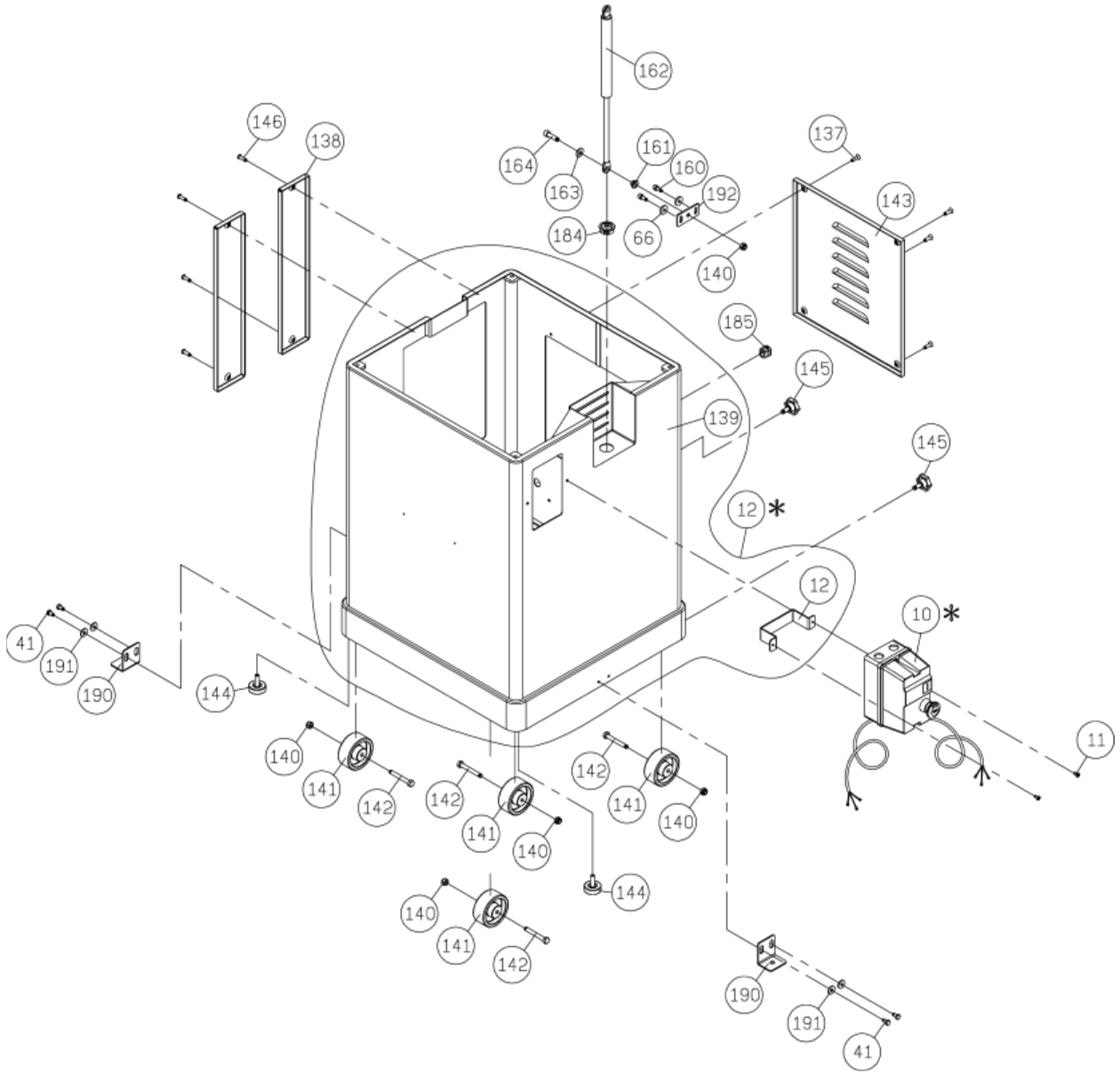

Headstock Assembly

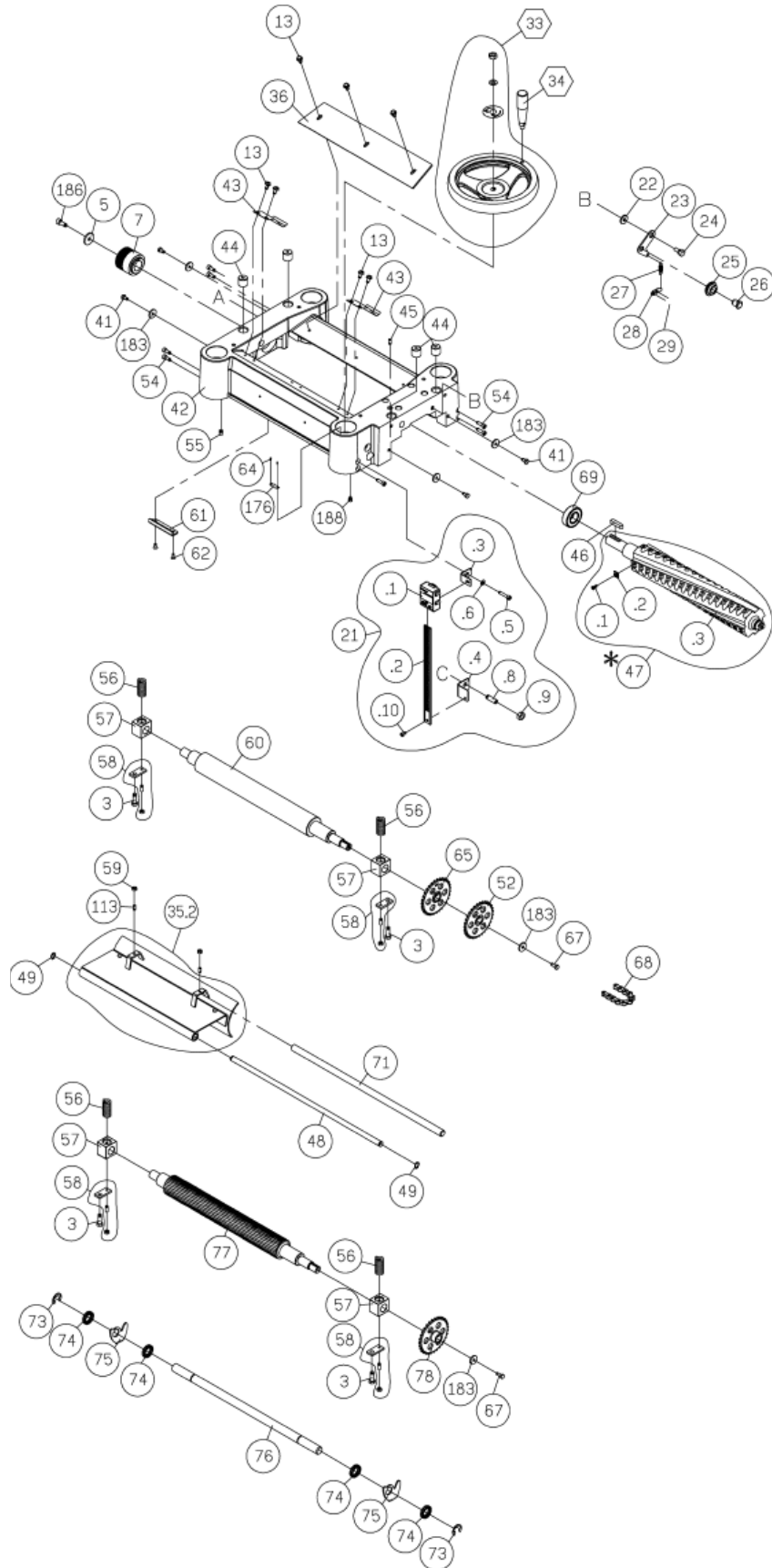

Gearbox Assembly and Dust Port Assembly

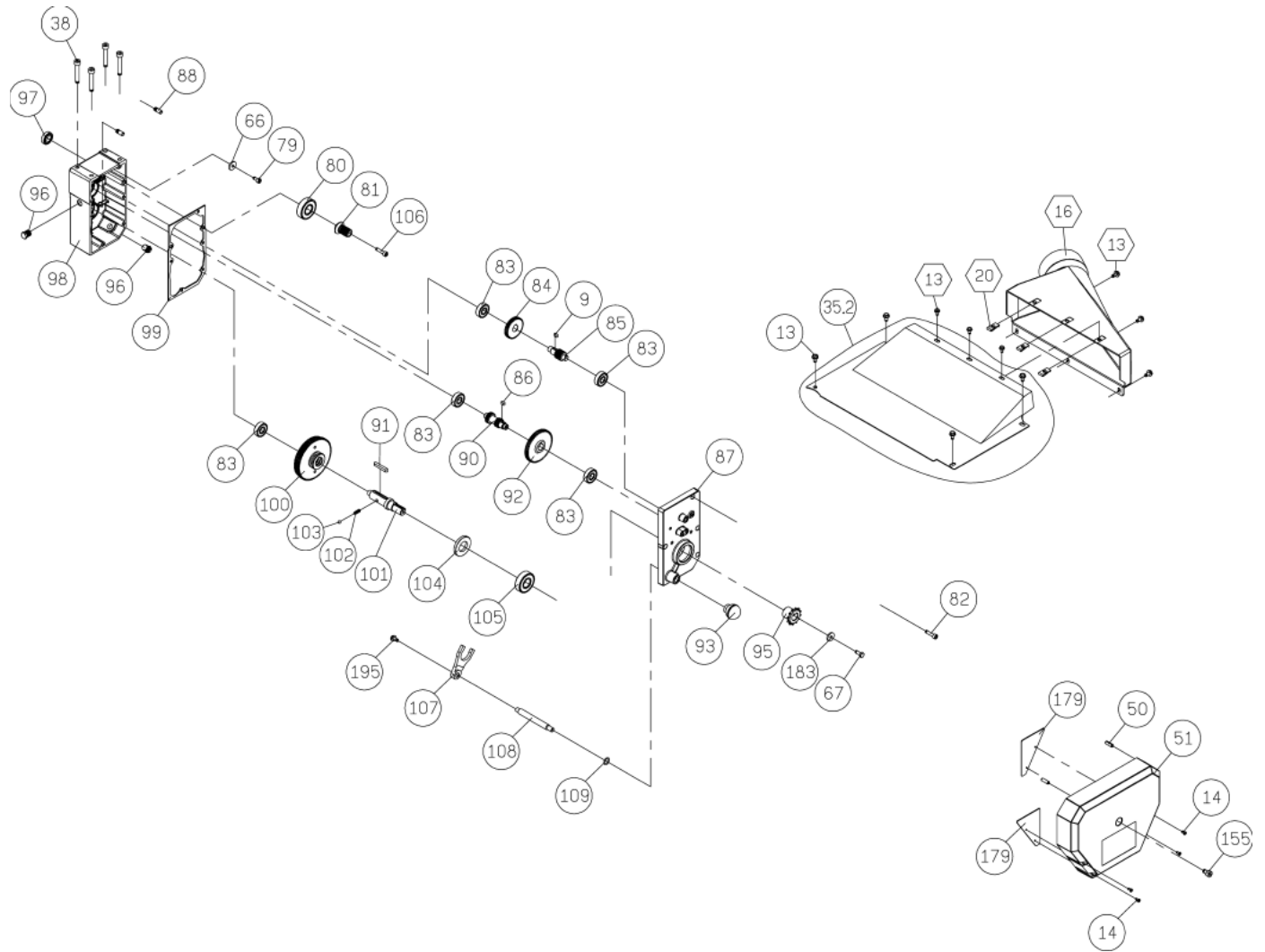

Key	Part No.	Descriptions	Specification	Q'ty
1	174751-000	BELT GUARD		1
2	014316-000	POLY-V-BELT	400J-9	1
3	000003-104	HEX. SCREW	M8*1.25P*20	4
4	230118-000	KNOB		2
5	006001-043	FLAT WASHER	8.2*30*4.0t	1
6	380147-901	SPECIAL BOLT		2
7	381421-902	CUTTER HEAD PULLEY		1
9	012003-003	KEY	5*5*12	1
10	937986-001	MAGNETIC SWITCH ASSEMBLY	3HP*220V-240V*1PH	1
10.1	473003-065	CSA WIRE FOR MOTOR	SJT14AWG*3C*1000mm	1
10.2	473003-066	CSA WIRE FOR POWER SOURCE	SJT14AWG*3C*2900mm	1
11	000303-103	ROUND HEAD SCREW	M5*0.8P*10	2
12	174663-902	SWITCH PLATE		1
13	000902-102	HEX. SCREW W/WASHER	M6*1.0P*12	17
14	002001-704	SOCKET HEAD CAP SCREW	M4*0.7P*8	4
15	000003-105	HEX. SCREW	M8*1.25P*25	8
16	250345-615	DUST CHUTE		1
18	006007-140	FLAT WASHER	10.5*32*1.0t	2
19	006001-040	FLAT WASHER	8*30*3.0t	1
20	170813-901	RETAINING CLIP		3
21	925026-000	DRO SOLD AS ASSEMBLY ONLY		1
21.1	491142-000	DIGITAL READ OUT (Reference only)		1
21.2	950791-000	SENSOR STRIP ASSEMBLY (Reference only)		1
21..3	174755-904	BRACKET-UPPER (Reference only)		1
21.4	174756-904	BRACKET-LOWER (Reference only)		1
21.5	000103-109	SOCKET HEAD CAP SCREW (Reference only)	M6*1.0P*30	1
21.6	006001-022	FLAT WASHER (Reference only)	6.3*13*1.0t	1
21.8	000205-102	SET SCREW (Reference only)	M10*1.5P*30	1
21.9	008007-100	HEX. NUT (Reference only)	M10*1.5P(17B*8H)	1
21.1	000102-102	SOCKET HEAD CAP SCREW (Reference only)	M5*0.8P*8	1
22	006001-041	FLAT WASHER	8.2*22*3.0t	13
23	170405-901	BRACKET		1
24	290039-901	SHAFT		1
25	130071-000	CHAIN TENSIONER		1
26	360349-901	CHAIN TENSIONER SHAFT		1
27	280050-000	SPRING		1

Key	Part No.	Descriptions	Specification	Q'ty
28	170406-901	HOOK		1
29	000103-102	SOCKET HEAD CAP SCREW	M6*1.0P*10	2
30	008008-100	HEX. NUT	M10*1.25P(17B*8H)	4
31	006001-078	FLAT WASHER	10.5*19*1.5t	4
33.1	240014-000	HAND WHEEL		1
33.2	230444-615	LOCK KNOB USED SPACER 361531-901		1
33.3	361531-901	SPACER USED WITH 230444-615 KNOB		1
33.4	570887-000	INDICATOR LABEL		1
34.0	230114-906	HANDLE		1
35.1	170419-000	DUST HOOD		1
35.2	170410-019	CHIP BREAKER w/GASKET		1
36.0	250158-617	CHIP DEFLECTOR		1
37	250159-615	COLUMN CAP		3
38	000104-114	SOCKET HEAD CAP SCREW	M8*1.25P*50	4
41	000002-101	HEX. SCREW	M6*1.0P*12	8
42	051440-000	HEAD CASTING		1
43	270015-901	SPRING PLATE		2
44	380200-901	TENSION BOLT		4
45	000203-106	SET SCREW	M6*1.0P*16	1
46	012204-001	KEY	8*8*36	1
47	924751-001	HELICAL CUTTER HEAD ASSY	4SLOTS	1
47.1	038201-101	TORX SCREW	#10-32UNF*1/2"	52
47.2	P-15mm 4S	INSERT (SOLD IN BOX OF 10)	15*15*2.5t	52
47.3	924659-001	HELICAL CUTTER HEAD ONLY		1
48	361362-902	FIXING SHAFT		1
49	010003-000	RETAINING RING	STW-12	2
50	011004-102	SPRING PIN	6*20	2
51	251324-615	GEAR CASE COVER		1
52	150025-000	CHAIN SPROCKET		1
54	000103-106	SOCKET HEAD CAP SCREW	M6*1.0P*16	8
55	000204-103	SET SCREW	M8*1.25P*12	1
56	280051-000	SPRING		4
57	130039-000	BUSHING		4
58	923901-000	RETAINER PLATE ASSEMBLY		4
59	008005-100	HEX. NUT	M6*1.0P(10B*5H)	2
60	360383-000	OUTFEED ROLLER		1
61	170409-901	LIMIT PLATE		1

Key	Part No.	Descriptions	Specification	Q'ty
62	000402-104	FLAT HEAD SCREW	M5*0.8P*12	2
64	002301-201	RIVET	2*5	2
65	150027-000	CHAIN SPROCKET		1
66	006001-020	FLAT WASHER	6.2*20*3.0t	5
67	000002-103	HEX. SCREW	M6*1.0P*16	3
68	016306-000	CHAIN	#06B*63P	1
69	030209-002	BALL BEARING	6205	1
71	360351-000	SHAFT		1
73	010209-000	RETAINING RING	ETW-15	2
74	250160-615	SPACER		40
75	172281-905	ANTI-KICK BACK		39
76	360352-000	SHAFT		1
77	360353-000	INFEED ROLLER		1
78	150028-000	CHAIN SPROCKET		1
79	000103-103	SOCKET HEAD CAP SCREW	M6*1.0P*12	1
80	030208-002	BALL BEARING	6204	1
81	320196-000	GEAR		1
82	000103-108	SOCKET HEAD CAP SCREW	M6*1.0P*25	5
83	030106-002	BALL BEARING	6201	5
84	320197-000	GEAR		1
85	320160-000	SHAFT		1
86	012003-002	KEY	5*5*10	1
87	090350-920	GEARBOX COVER		1
88	360355-901	PIN		2
90	320205-000	SHAFT		1
91	012004-003	KEY	6*6*40	1
92	320198-000	GEAR		1
93	250372-615	KNOB		1
94	016303-000	CHAIN	#06B*47P	1
95	150008-000	CHAIN SPROCKET		1
96	043401-000	PLUG	PT1/4"-19	2
97	043608-000	OIL SEAL	TCX4 28*40*8	1
98	090349-920	GEARBOX		1
99	340012-615	GEARBOX GASKET		1
100	922351-001	GEAR ASSEMBLY		1
101	360357-000	SHAFT		1
102	280052-000	SPRING		1

Key	Part No.	Descriptions	Specification	Q'ty
103	017002-000	STEEL BALL	6mm	1
104	043505-000	OIL SEAL	SC25*47*6	1
105	030109-002	BALL BEARING	6204	1
106	002602-106	CAP LOCKING SCREW	M6*1.0P*25	1
107	070014-000	SHIFTING FORK		1
108	360358-901	SHAFT		1
109	043303-000	RETAINING RING	P12	1
111	130040-000	NUT		4
112	360359-000	COLUMN SHAFT		3
113	000203-104	SET SCREW	M6*1.0P*12	6
114	050277-000	COLUMN		3
116	360360-901	ECCENTRIC SHAFT		4
117	000204-105	SET SCREW	M8*1.25P*20	6
118	921209-001	ROLLER W/BALL BEARING (608)		2
119	000205-101	SET SCREW	M10*1.5P*12	8
120	016220-000	CHAIN	Z410*134P	1
121	010006-000	RETAINING RING	STW-15	1
122	150009-000	CHAIN SPROCKET		1
123	360362-901	SPROCKET SHAFT		1
124	170413-901	CHAIN TENSIONER BRACKET		1
125	051409-000	BASE CASTING		1
126	030003-001	BALL BEARING	6202	4
127	010103-000	RETAINING RING	RTW-35	4
128	150010-000	CHAIN SPROCKET		4
129	570888-000	SCALE		1
130	000301-101	ROUND HEAD SCREW	M3*0.5P*6	2
131	050279-000	MAIN COLUMN		1
132	000003-106	HEX. SCREW	M8*1.25P*30	4
133	010104-000	RETAINING RING	RTW-38	1
134	130041-000	BUSHING		1
135	012002-007	KEY	4*4*20	1
136	360364-000	ELEVATING SCREW		1
137	000403-104	FLAT HEAD SCREW	M6*1.0P*20	4
138	174577-000	COVER		2
139	174752-000	STAND		1
140	008306-100	HEX. LOCK NUT	M8*1.25P(13B*9H)	9
141	250399-615	WHEEL		4

Key	Part No.	Descriptions	Specification	Q'ty
142	000003-316	HEX. SCREW	M8*1.25P*60	4
143	170445-000	STAND ACCESS PANEL		1
144	230049-000	FOOT		2
145	004001-101	KNOB	5/16"-18NC*3/4"	2
146	000801-104	ROUND HEAD HEX SCREW	M6*1.0P*20	4
153.1	603160-008	MOTOR	3HP*220-240V*60HZ*1PH	1
153.3	012206-002	KEY	6*6*18	1
153.4	002601-107	CAP LOCKING SCREW	M8*1.25P*25	1
153.5	381422-902	MOTOR PULLEY		1
153.6	006001-043	FLAT WASHER	8.2*30*4.0t	1
154	174754-902	MOTOR BRACKET		1
155	000104-113	SOCKET HEAD CAP SCREW	M8*1.25P*45	1
156	000204-109	SET SCREW	M8*1.25P*40	1
157	001803-102	CAP SCREW W/SPRING WASHER	M8*1.25P*20/8.2*13.7	4
158	050429-000	EXTENSION WING		2
159	174753-000	PLATE		1
160	001802-101	CAP SCREW W/SPRING WASHER	M6*1.0P*16/6.5*10.5	10
161	361323-902	BUSHING		3
162	660291-000	GAS CYLINDER	350N	1
163	006001-054	FLAT WASHER	8.5*20*2.0t	3
164	000104-110	SOCKET HEAD CAP SCREW	M8*1.25P*30	2
165	000704-103	PAN HEAD SCREW	M8*1.25P*35	1
168	040004-000	HEX WRENCH (Local Purchase)	4mm	1
170	174569-904	COMBO WRENCH (Local Purchase)	10*13	1
171	040204-000	COMBO WRENCH (Local Purchase)	12*14	1
172	040206-000	COMBO WRENCH (Local Purchase)	17*19	1
179	174659-902	SIDE COVER GUARD		2
183	006001-021	FLAT WASHER	6.2*22*3t	7
184	021802-000	RELIEF BUSHING	NB-2430	1
185	020004-000	STRAIN RELIEF	SB8R-1	1
186	002601-107	CAP LOCKING SCREW	M8*1.25P*25	1
188	000102-101	SOCKET HEAD CAP SCREW	M5*0.8P*6	1
190	174711-000	SHIPPING PLATE		2
191	006001-036	FLAT WASHER	6.7*19*2.0t	4
192	174769-000	ADJUSTABLE BRACKET		2
194	660329-000	GAS CYLINDER	600N	1
195	029502-201	HEX. SCREW W/LOCK WASHER	M6*1.0P*12	1

Maintenance Record

Date	Task	Operator

Notes

Current

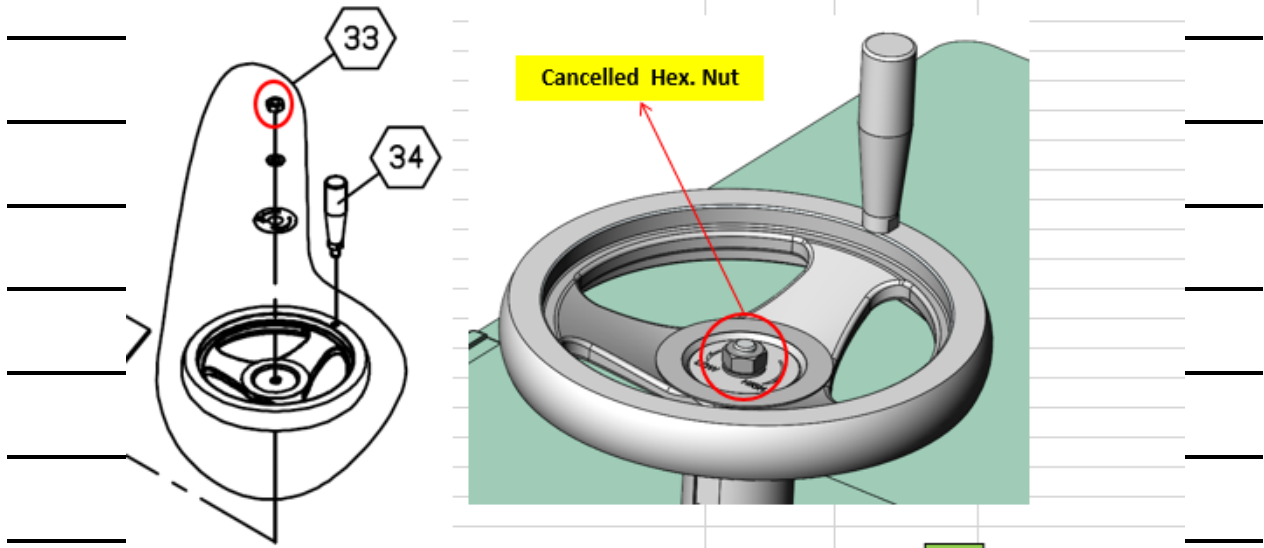

New

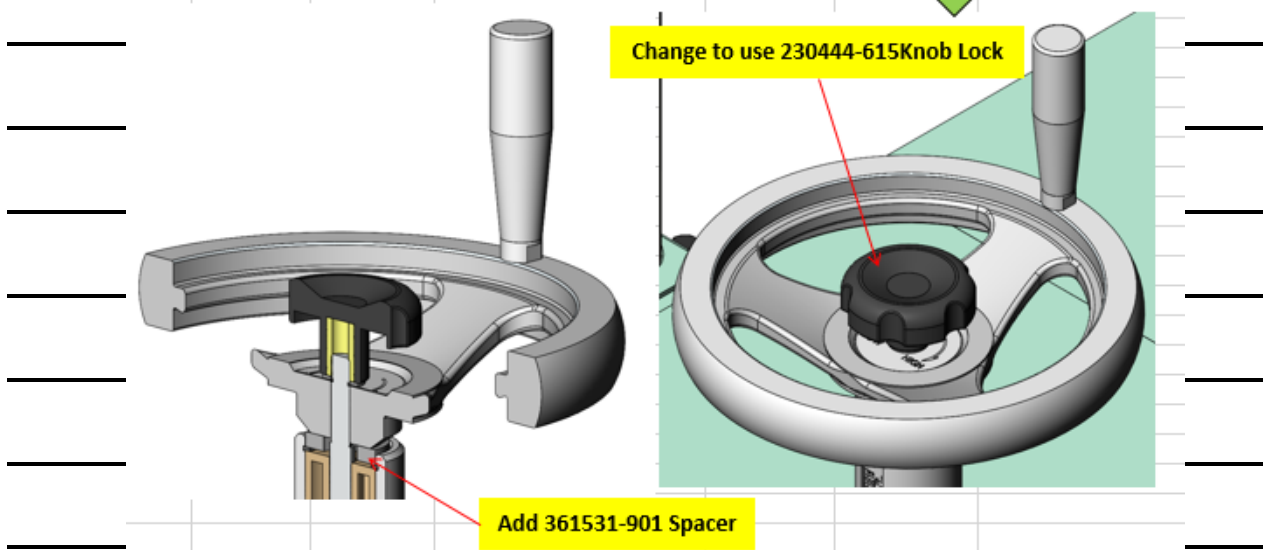

Warranty and Service

Oliver makes every effort possible to assure that its equipment meets the highest possible standards of quality and durability. All products sold by Oliver are warranted to the original customer to be free from defects for a period of 2 (two) years on all parts, excluding electronics and motors, which are warranted for 1 year. Oliver's obligation under this warranty shall be exclusively limited to repairing or replacing (at Oliver's option) products which are determined by Oliver to be defective upon delivery F.O.B. (return freight paid by customer) to Oliver, and on inspection by Oliver. This warranty does not apply to defects due, directly or indirectly, to misuse, abuse, negligence, accidents, unauthorized repairs, alterations, lack of maintenance, acts of nature, or items that would normally be consumed or require replacement due to normal wear. In no event shall Oliver be liable for death, personal or property injury, or damages arising from the use of its products.



Oliver Machinery is always adding new Industrial Woodworking products to the line.

For complete, up-to-date product information, visit us online at:

WWW.OLIVERMACHINERY.NET

or call toll free 1-800-559-5065

**** SAVE THIS MANUAL FOR FUTURE REFERENCES. ****